

Duplexvent MULTI Eco-V

Heat Recovery Ventilation



2016 / 2018

KEY FEATURES

- Heat recovery ventilation
- 100% customisation
- 93% thermal efficiency
- Vertical duct connections
- Low energy EC fans
- Automatic 100% bypass
- Built-in heating / cooling coils
- Integrated web server enables to control the unit via internet
- BMS connection (Modbus as a standard, optional BACnet or KNX)
- VAV control compatibility
- 2 year warranty +

Duplexvent MULTI Eco-V

As a ventilation specialist we aim to provide ventilation solutions for commercial applications thanks to our broad range of Commercial Heat Recovery units in excess of 16,000 m³/hr air volume with the availability of indoor and outdoor versions.

To offer you the greatest choice in meeting your commercial ventilation needs, we have expanded our Multi line to include the Multi-Eco line of energy efficient units, which still match your specification in terms of installation flexibility, performance and quality by meeting the high air volume requirements for commercial and large industrial spaces.

+ excludes motors. Motor warranty one year from date of purchase.

MULTI Eco-V LINE UNIT CONFIGURATION

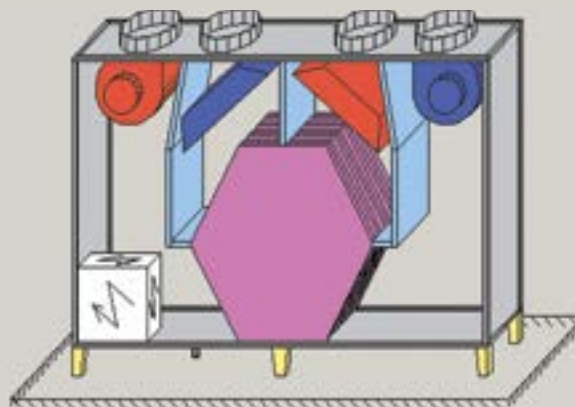

Upright

(Maintenance access from the side)





100% CUSTOMISATION AND SHORT DELIVERY TIME

Multi Eco-V Line MVHR units follow the business philosophy of multiple variability. Designers can easily modify unit positions, spigot connections, filters, integral heating /cooling coils, bypass and circulation dampers using the selection software which accelerates the specification

process and helps meet stringent project requirements. Despite the full customisation Multi Eco-V Line units are delivered in a period of **4-6 weeks** to meet tight project deadlines.

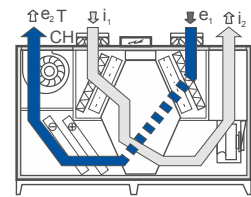
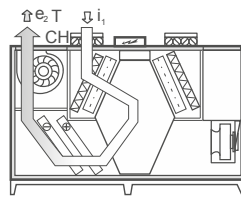
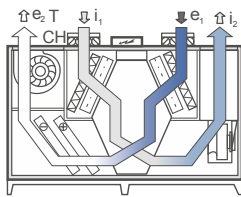

→ e₁ ... Fresh outdoor air suction
 ↘ e₂ ... Fresh filtered air outlet

↘ i₁ ... Exhaust air suction
 ↘ i₂ ... Exhaust air outlet

T... Central heating connection
 CH... Cooling connection

Ventilation with heat recovery

Circulation damper helps regulate indoor temperature / humidity conditions

100% Bypass facility delivers cool, fresh and filtered air

DUPLEXVENT MULTI Eco-V SIZE RANGE

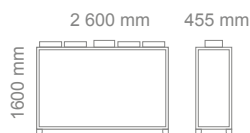

Multi Eco-V DV1500

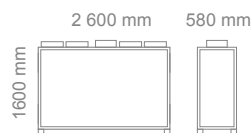

Multi Eco-V DV2500



Multi Eco-V DV3500

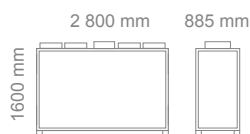

Multi Eco-V DV4500

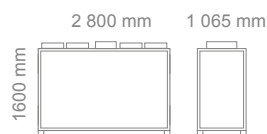

Multi Eco-V DV5500

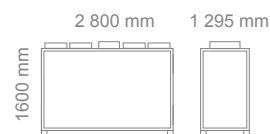

Multi Eco-V DV6500



Duplexvent MULTI Eco-V

Multi Line Customised Indoor -
Up to 7800m³/hr air volume



KEY FEATURES

- Fully customised commercial units in 6 different sizes up to 7600 m³/hr at 200 Pa
- Digital Touchscreen or simple manual controller
- Low noise, refer to NR35 and BB93 standards
- Excellent thermal insulation (class T2, TB1)
- G4, M5 or F7 filters available
- Optional circulation damper
- Optional constant flow and constant pressure mode
- BREEAM and ErP 2016 / 2018 compliant
- Meets Building Regulations Part L2A and L2B

PERFORMANCE

Duplexvent Multi Eco-V		DV1500	DV2500	DV3500	DV4500	DV5500-	DV6500
Supply air - max. ¹	m ³ /hr / l/sec	2050 / 569	3050 / 847	5400 / 1500	5900 / 1639	7400 / 2055	7800 / 2166
Extraction air - max. ¹	m ³ /hr / l/sec	1800 / 500	2700 / 750	5300 / 1472	5400 / 1500	7000 / 1944	7700 / 2139
Heat recovery efficiency ²	%	up to 93%					
Fan type		EC (backward curved impeller)					
Weight ³	kg	210-290	300-380	360-430	380-460	490-570	590-680
Max power input	kW	1.2	2.3	5	5	6.6	6.6
Voltage	V	230					
Frequency	Hz	50					
RPM - max.	min ⁻¹	2920	3000	2980	2980	2700	2700
Heating output T - max. ⁴	kW	22	30	42	51	71	88
Cooling output CHW - max. ⁴	kW	16	22	30	42	56	62
Cooling output CHF - max. ⁴	kW	10	13	25	37	41	50
Part No.		90000801	90000802	90000803	90000804	90000805	90000806

1. Maximum flow rate at zero external pressure
2. According to air volume
3. Depending on equipment
4. Depending on register type, liquid and flow rates

T - Water heating coil
CHW - Water cooling coil
CHF - DX (direct evaporator) coil

ACOUSTIC POWER L_w AND PRESSURE PL_p

Type	Working point	Acoustic power L_w [dB(A)]					Acoustic pressure PL_p [dB(A)] at 3 m
		inlet e ₁	inlet i ₁	inlet e ₂	inlet i ₂	unit	
Duplexvent Multi eco-V DV1500	1500m ³ /hr (200 Pa)	54	59	81	81	66	45
Duplexvent Multi eco-V DV2500	2500m ³ /hr (200 Pa)	66	70	82	91	76	55
Duplexvent Multi eco-V DV3500	3500m ³ /hr (200 Pa)	64	63	91	91	74	52
Duplexvent Multi eco-V DV4500	4500m ³ /hr (200 Pa)	67	67	92	88	66	58
Duplexvent Multi eco-V DV5500	5500m ³ /hr (200 Pa)	69	70	95	93	68	61
Duplexvent Multi eco-V DV6500	6000m ³ /hr (200 Pa)	72	75	96	88	78	59

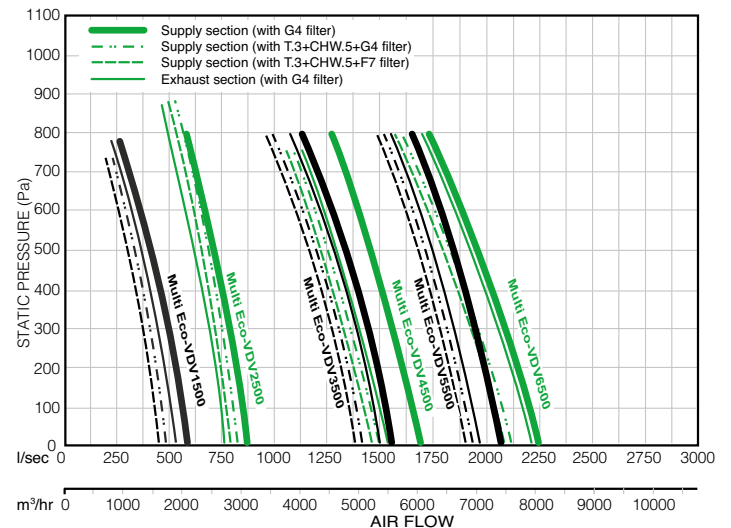

PERFORMANCE

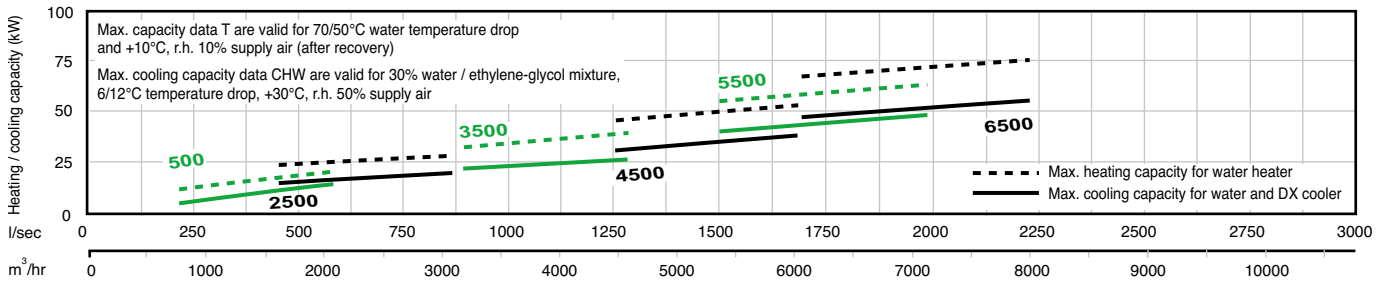
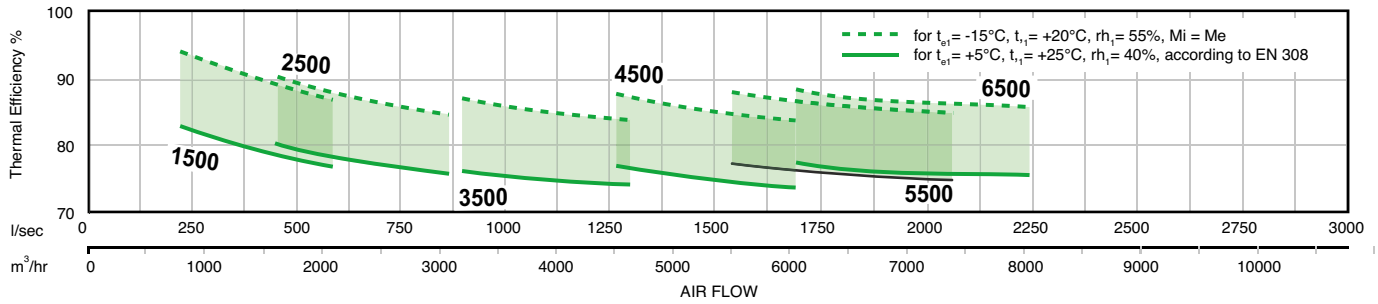

DIMENSIONS

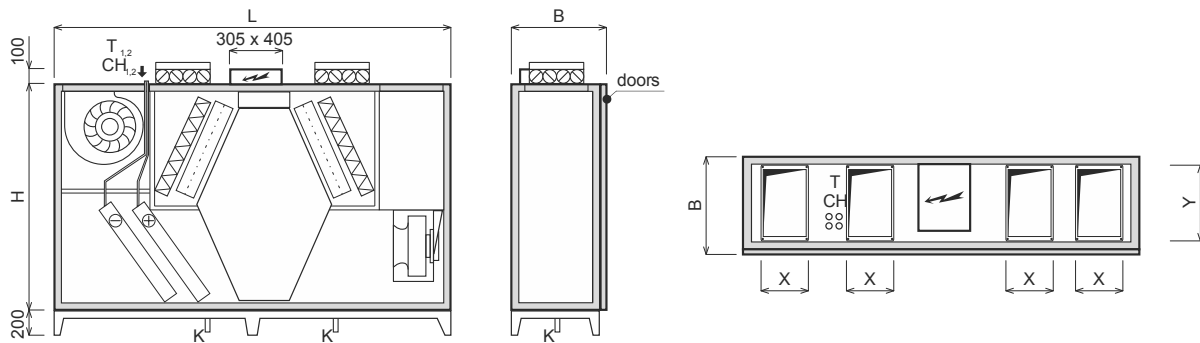

Duplexvent Multi Eco-V		DV500	DV1000	DV1500	DV2500	DV3500	DV5000
Dimension H	mm	1600	1600	1600	1600	1600	1600
Dimension B	mm	455	580	775	885	1065	1290
Length L	mm	2600	2600	2800	2800	2800	2800
Condensate drain	mm	Ø32					
Connecting Ports							
Dimension X x Y	mm	300 x 250	300 x 400	400 x 400	400 x 600	400 x 710	400 x 900

Call: 01494 560800

Visit: airflow.com



Airflow Developments Limited
Aidelle House, Lancaster Road,
Cressex Business Park,
High Wycombe, Buckinghamshire,
United Kingdom, HP12 3QP

E-mail: info@airflow.com
Telephone: +44 (0) 1494 525252

airflow.com

© Airflow Developments Limited. Airflow Developments Limited reserve the right, in the interests of continuous development, to alter specifications without prior notice. All orders are accepted subject to our conditions of sale which are available on request



80000678 Issue 1 06/17