

COMMERCIAL MVHR SOLUTIONS

EXPERTS IN MECHANICAL VENTILATION WITH HEAT RECOVERY



RESIDENTIAL FANS



HEAT RECOVERY



COMMERCIAL FANS



DUCTING ACCESSORIES



CONTENTS



Introduction

What is MVHR?	6
Airflow Developments	7
Typical Applications & Case Studies	8

Duplexvent Flexi

DV650	22
DV1100	26
DV1600	30
DV2600	34
DV3600	38

Duplexvent Multi eco

DV500	50
DV800	54
DV1100	58
DV1500	62
DV2500	66
DV3500	70
DV4500	74
DV5500	78
DV6500	82
DV7500	86
DV9000	90

Duplexvent Multi eco-V

DV1500	100
DV2500	104
DV3500	108
DV4500	112
DV5500	116
DV6500	120

Duplexvent Multi eco Roof

DV1500	130
DV2500	134
DV3500	138
DV4500	142
DV5500	146
DV6500	150
DV7500	154
DV9000	158

Duplexvent Rotary

DV1500	170
DV2500	174
DV4000	178
DV5000	182
DV8000	186
DV12000	190
DV15000	194

Duplexvent Rotary Roof

DV1500	204
DV2500	208
DV4000	212
DV5000	216
DV8000	220
DV12000	224
DV15000	228

Susurro

Susurro 400	234
Susurro 700	234
Susurro 1000	234

VAV Systems & Accessories

Silent + mini orange pumps	259
Max Hi-Flow Pumps	260
NOx Filters	261
VAV System	262
DX Coil	266
Accessories	267

Adroit

DV51CH	274
DV96	282
DV110	286
DV145	290
DV245	294
DV50	298
DV80	302

Multiplex Box

Multiplex Box	306
---------------	-----

Unohab

Unohab	308
--------	-----

CATEGORIES



Duplexvent Flexi

Intro page 14



DUPLEXVENT®

A range of five centralised commercial heat recovery units with a flow rate up to 1484 l/s (5342 m³/h) at 200 Pa. Suitable for commercial and industrial applications, these units are available in a range of sizes and configurations.



Duplexvent Multi eco

Intro page 42



DUPLEXVENT®

An eleven unit, side entry range of MVHR, with a flow rate up to 3083 l/s (11100 m³/h) at 200 Pa. Customisable to the projects specification, these units are very versatile.



Duplexvent Multi eco V

Intro page 94



DUPLEXVENT®

Six MVHR units with top entry access. These indoor units have a flow rate up to 3083 l/s (11100 m³/h) at 200 Pa. Suitable for commercial and industrial applications these units are customisable to the projects specification.



Duplexvent Multi eco Roof

Intro page 124



DUPLEXVENT®

An eight unit range with a flow rate up to 3083 l/s (11100 m³/h) at 200 Pa. These units are suitable for outdoor installation, on the roof of buildings, where space inside the building is minimal.

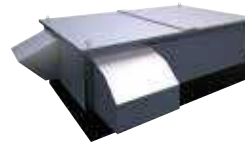

Duplexvent Rotary

Intro page 162



DUPLEXVENT®

Seven indoor MVHR units that utilise a rotary wheel heat exchanger. The range has a flow rate up to 4444 l/s (16000 m³/h) at 200 Pa.



Duplexvent Rotary Roof

Intro page 198



DUPLEXVENT®

Seven MVHR units with a flow rate up to 4000 l/s (14400 m³/h) at 200 Pa. The Rotary Roof range is suitable for outdoor installations on top of buildings where room internally is short for space.



CATEGORIES



Susurro

Intro page 234



Susurro®

This range is built up of three decentralised units with a nominal flow rate up to 283 l/s (1018 m³/h). Designed for classrooms, office, and large open spaces these decentralised units help reduce energy consumption of the room whilst improving the indoor air quality.



VAV System and accessories

Intro page 262

DUPLEXVENT®

VAV Systems optimise the performance of an MVHR unit and reduce the ongoing operating costs of your ventilation system through air flow regulation for individual areas. Also available is a wide range of additional accessories suitable for the Duplexvent Commercial MVHR Units.

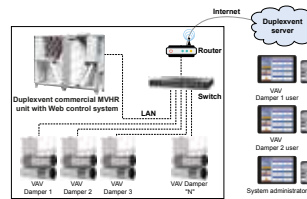

Example system
Duplexvent commercial MVHR unit with Web control

Adroit

Intro page 272



Adroit®

A range of seven whole house heat recovery units suitable for domestic applications. Also, part of the Adroit range is the cooker hood unit which incorporates a cooker hood extract fan and heat recovery in one discrete unit.



MultiPlexBox

Intro page 306

MultiPlexBox®

Air distribution box ensuring silent, demand-based supply and extract ventilation. These air distribution boxes are suitable for both commercial and industrial applications.



Unohab

Intro page 308



Unohab

A single room unit providing heat recovery efficiency of up to 88%. The Unohab has minimum space requirements due to its small footprint which makes it the perfect option for small apartments and flats.



MECHANICAL VENTILATION WITH HEAT RECOVERY

Mechanical Ventilation with Heat Recovery (MVHR) is a form of continuous ventilation that recovers the heat that would otherwise be lost as part of the usual extraction process.

MVHR works by continuously preheating the incoming, cool supply air that is brought in from outside with the warm, outgoing extract air. The heat from the outgoing extract air is recovered via a highly efficient heat exchanger. This recovered heat travels through the plates found in the heat exchanger and radiates into the incoming air; warming it as it does so.

Typically, both the supply and extract air, pass through air filters before passing through the heat exchanger. These air filters, depending on their grade, will remove various air pollutants, such as pollen, dust, black carbon and leaves from the air. As a result, the health of those inside the building is protected, as they will be breathing less polluted air.

Furthermore, by utilising an MVHR unit with air filters, the MVHR's heat exchanger is protected by removal of these airborne pollutants from the incoming and outgoing air streams.

One way to gauge the performance of the heat recovery unit is through its thermal efficiency. The thermal efficiency of the best performing units can be over 90%, which can significantly reduce the ongoing heating bills of the property. The reduction of the property's energy bills is due to the heating system not needing to be on as long as it normally would. Furthermore, maintaining the indoor air temperature is easier, as when the heating system is on, it won't need to warm the air by such a large margin, i.e. it would only need to warm the air by 1°C rather than +10°C.

Commercial MVHR units, like their residential counterparts, also utilise a summer bypass facility. Airflow's commercial MVHR units utilise an automatic 100% bypass facility. This means that the heat exchanger is totally isolated when the indoor air temperature is too high and the outside temperature is lower than the temperature in the room; thereby preventing unnecessary heat recovery taking place and minimising the risk of overheating within the building.





MORE THAN 60 YEARS OF EXPERIENCE

Founded in 1955, Airflow has grown from one man's expertise in fan design and air flow measurement into a thriving international group. Renowned for its innovative approach to new product development and air movement techniques, Airflow can offer you a variety of ventilation solutions to suit your needs.

With headquarters in High Wycombe, where the business was founded, Airflow has subsidiaries in Germany and the Czech Republic and has global distributors from Norway to New Zealand.

Airflow's knowledgeable and committed staff continually develop new and innovative products that raise standards and provide long term, reliable ventilation solutions.

RESPONSIBLE MANUFACTURING

ISO 9001 Quality Matters!

ISO 9001 – Airflow was the 152nd company to achieve the ISO 9001 standard and is currently one of few companies with ISO 9001:2015 certification. This ensures that all products that Airflow produce are stringently tested to provide customers with quality ventilation systems.



ISO 14001 Environmental Matters!

ISO 14001 – Airflow is also committed to reducing its impact on the environment and has achieved the ISO 14001:2015 standard. This commitment sees Airflow striving to improve efficiency whilst reducing energy usage, waste and consumption.



BIM

BIM Airflow products are provided in BIM file format. Other formats ie: DWG, PDF are also available.



ErP Airflow manufactures ErP compliant fans and ventilation systems; ensuring that you are receiving energy efficient ventilation systems that perform.



Passive House

In a drive to reduce energy consumption, Airflow produces a large range of residential and commercial MVHR units with Passive House certification. This certification means that the units use minimal energy and help to reduce energy consumption, heat loss and energy bills of the building.



BESA

BESA Affiliate: Building Engineering Services Association takes an active interest in the building services and wider construction industries, voicing the views of members and driving for initiatives that represent the best interests of those who work within the built environment.



CIBSE APPROVED CPD

Understanding Mechanical Ventilation with Heat Recovery for Commercial Applications.

Duplexvent - Versatile Solutions

DUPLEXVENT INSTALLATIONS

John Radcliffe Hospital



John Lennon Building



Oxford University



Adelphi Building – Spotify Floors

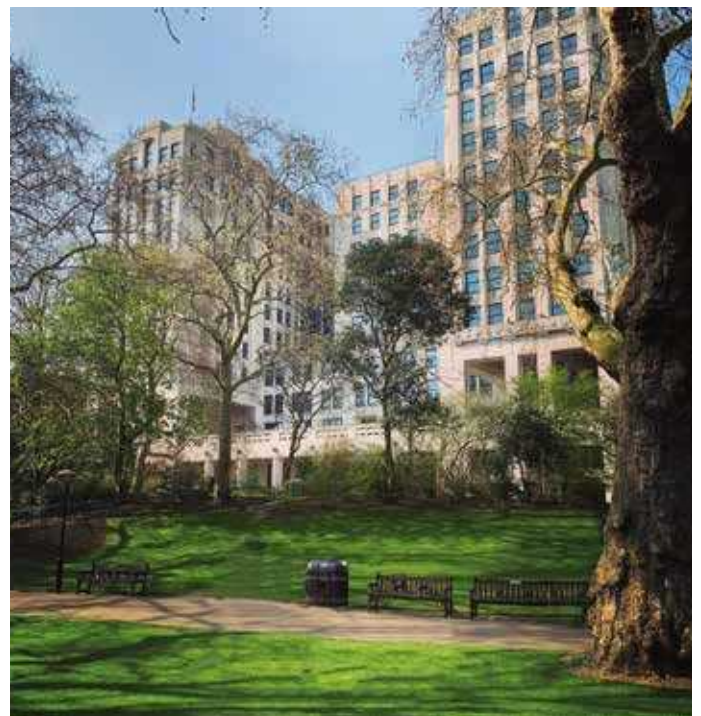

SMALL APARTMENT SOLUTION

A Heat Recovery Unit
with a Cooker Hood

Efficient use of space



Adroit® DV51

Compact apartment unit

Features

- Flow rate up to 47 l/s (170 m³/h) at 100 Pa.
- Up to 84% thermal efficiency and low SFP.
- Internet control by smart phone, tablet or PC.
- Two G4 (ISO Coarse > 75%) and one F7 (ISO ePM1) filters.
- Optional LCD digital controller with four independent environmental profiles.
- Optional built-in electric heater.
- Complies with Building Regulations.

Adroit® DV51CH

Compact apartment unit incorporating a cooker hood extractor

Features

- Slim and stylish extractor hood available in white and brushed stainless steel.
- Fits neatly as part of an integrated solution.
- Full heat recovery for the whole dwelling (recovers also the heat from the hob).
- Modern and intuitive capacitive touch button on the cooker hood front panel.
- Built-in humidity sensor.
- 600 mm wide.
- Available in right- and left-hand versions.

Duplexvent - Versatile Solutions

TYPICAL APPLICATIONS

MULTI DV1500



FLEXI DV2600



MULTI-N DV1500



FLEXI DV3600



MULTI-N DV5000



MULTI-N DV3500



MULTI-N DV6500



MULTI DV8000





Improving Indoor Air

RESIDENTIAL FANS



RESIDENTIAL AND COMMERCIAL
MECHANICAL HEAT RECOVERY
AIR HANDLING UNITS



Ventilation Solutions from a House to a High Rise

AIRFLOW 

airflow.com

Tel: 01494 525252



SETTING THE STANDARD



Eliminating pollutants from the workplace



Ventilation with Heat Recovery

Centralised Commercial

The Duplexvent range of centralised commercial heat recovery units reduces the ongoing energy bills of the premises whilst improving its indoor air quality. Suitable for commercial and industrial applications, these units are available in a variety sizes and configurations and use highly efficient polypropylene heat exchangers to recover the heat from the extract air and use it to pre-warm the incoming supply air.

DUPLEXVENT Flexi

Available in five sizes, Duplexvent Flexi units meet the ventilation and energy requirements of modern and energy efficient buildings. Achieving first class thermal efficiency levels (up to 93%), they are also the first Passive House Institute certified commercial MVHR units available in the UK.

The Duplexvent Flexi range offers the following benefits: quiet and energy efficient EC motors, Internet connection with smartphone compatibility, BMS connectivity (Modbus TCP), automatic frost protection and an automatic 100% summer bypass facility.

Unique to all Duplexvent Flexi units is the ability to mount the same unit in different positions. A Flexi unit can be installed on the floor (standing or flat) or under the ceiling, providing exceptional flexibility for designers. Similarly, HVAC distributors benefit from a range of "off-the-shelf" air handling units that can be quickly adapted to install onsite.

DUPLEXVENT Rotary

The Duplexvent Rotary and Rotary Roof ranges both comprise of seven units that utilise a rotary wheel heat exchanger. The rotary wheel heat exchanger found in all Duplexvent Rotary and Rotary Roof units recover up to 85% of the heat that would otherwise be lost to the atmosphere.

The Duplexvent Rotary range, thanks to its versatility and various mounting positions can be easily installed inside the building. Conversely, the Duplexvent Rotary Roof, with its weather protection, offers significant durability for an outdoor unit.

Both ranges offer the user the following benefits: VAV and BMS connectivity, low energy and quiet EC motors, compact (modular in larger units) design and a wealth of optional equipment to ensure that your ventilation and energy requirements are met.

Furthermore, all Rotary and Rotary Roof units comply with ErP 2018 and BREEAM standards and are certified by TÜV and have Eurovent certified heat exchangers.

Using commercial MVHR units helps the building to be assessed to the BREEAM (BRE Environmental Assessment Method) standard and meet the MEES (Minimum Energy Efficiency Standards) requirements. By meeting these standards, the building will have low ongoing energy bills and be environmentally friendly, whilst protecting its occupants' health with healthy indoor air.

DUPLEXVENT Multi eco

The Duplexvent Multi eco range of commercial MVHR units provides outstanding ventilation and thermal efficiency with market leading energy efficiency; providing you with one of the most environmentally friendly ventilation systems available.

Available in 72 different configurations and in outdoor (Multi eco Roof) and top entry (Multi eco-V) and indoor, side entry (Multi eco) versions, the Multi eco range are amongst the most versatile commercial MVHR products available on the market.

The Duplexvent Multi eco is available in 11 different sizes, providing a flow rate of up to 11,100 m³/h at 200 Pa. The top entry Duplexvent Multi eco-V is available in 6 sizes with a flow rate up to 7,450 m³/h at 200 Pa. The outdoor Duplexvent Multi eco Roof is an 8 unit range with a flow rate of up to 11,100 m³/h at 200 Pa.

All units are customised to the project's specification and incorporate highly efficient cross-counter-flow heat exchangers that achieve up to 93% thermal efficiency. Economical and extremely quiet Electronically Commutated (EC) motors can also be found in all units across all the Duplexvent Multi eco ranges.

Additional benefits of the Duplexvent Multi eco include Internet connectivity and the ability to be controlled by a smartphone or through a Building Management System (BMS) via Modbus, KNX or BACnet. The entirety of the range can also be integrated with Variable Air Volume (VAV) systems; offering a more affordable approach to zonal, demand based ventilation.

All Duplexvent Multi eco utilise an automatic, 100% summer bypass facility and frost protection. Furthermore, they can all be fitted with built-in heating and cooling coils.

Duplexvent Flexi

Heat Recovery Ventilation

KEY COMPONENTS

Models available:

DV650, DV1100, DV1600, DV2600 and DV3600



100% Summer Bypass Facility provides a flow of cooler, fresh and filtered air into the property installation

Digital Control Box with internet and BMS connections

DV1600 only

Interchangeable Spigot Connections simplify on-site installation

M5 (ISO ePM10 70%) F7 (ISO ePM2.5 65%) High Grade Filters provide ultra hygienic indoor climate and protect heat exchangers from getting dirty

Smooth Internal Casing with 30mm insulation avoids thermal bridging, absorbs noise and meets sanitary standards

Cross-Counter Flow Heat Exchangers up to 93% thermal efficiency

Condensate Drain for floor standing installations

Remote control via smart phone or laptop ensures control Flexibility and reduces service costs



Safety Switch to shut off the power in case of emergency

Condensate Drain for ceiling - suspended installations on inside of door

DV1600 only

Round Sippots DV1100 / DV1600

Rectangular Sippots DV650 / DV2600 / DV3600

External Options heater / cooler bolted to the unit

Low Energy, Maintenance Free EC Fan Technology ensures long term savings on operating costs

Pressure Sensors for filter monitoring

Temperature Sensors for fully automatic operation of the summer bypass, frost protection and heater / cooler facilities

Lockable Large Access Doors simplify and accelerate the maintenance process



All Duplexvent Flexi units are supplied with lockable doors

Duplexvent Flexi

Heat Recovery Ventilation



KEY FEATURES

- Heat recovery ventilation
- Up to 93% thermal efficiency
- Low energy Electronically Commutated (EC) fans
- Versatile unit positioning
- Automatic, 100% bypass
- Integrated web server enables unit control via the Internet
- BMS via Modbus as standard (Optional connection via KNX BACnet available)
- Off the shelf delivery
- VAV control compatibility
- Passive House Institute certified
- 2 year warranty +

DUPLEXVENT FLEXI

The indoor climate is of the utmost importance as most of us spend the greater part of our lives indoors. To ensure comfort and a sense of well-being, the air we breathe must be clean, and also be at the right temperature and humidity level. To most people, this is so self-evident that they do not give it a second thought.

Whatever the situation, Mechanical Ventilation with Heat Recovery (MVHR) solutions from Airflow can play a significant role because they help create a healthier living and working environment, while contributing to the reduction of a building's carbon emissions and energy usage.

Unique to the Duplexvent Flexi Line is the ability to position the unit on the floor or in a ceiling suspended position. Also this universal design allows the unit to be installed as either a left or right hand version.

This provides exceptional Flexibility for designers in the specification phase and gives contractors the opportunity to locate the unit in the optimum position. Similarly HVAC distributors benefit from a range of "off the shelf" air handling units which can be quickly adapted to fit on-site. No more bespoke orders with long lead times!

+ Excludes motors. Motor warranty one year from date of purchase



Ceiling Suspended



Floor Standing

- 1. Base Unit**
(Flexi DV650 / DV1100 / 1600 / 2600 / 3600)
- 16 Installation Configurations**
- +3 Upgrade Packs**



2018



WHOLE LIFE COST SAVINGS

Building Operators and Asset Managers will appreciate the Flexi range's innovative built-in Internet connection with user and service interface, allowing service technicians to connect to the unit from a remote location.

The Flexi's service interface continuously checks the operating status of the unit, and in the event of a fault, immediately

diagnoses the fault and instructs the user what to do. This feature saves on service call outs.

This unique feature minimises the service process and creates a secondary control display for the user.



Optional water / DX heating and cooling coils help maintain optimum indoor conditions

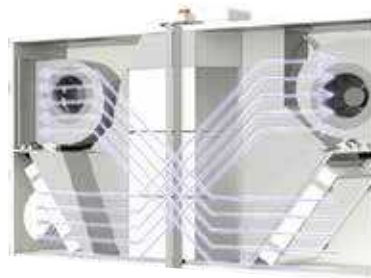

Versatile unit positioning enables right or left hand configuration on the same unit



Interchangeable spigot design allows the spigot connections to be changed on-site (DV1600)

UPGRADE PACKS

1. Passive House Pack

- Electric pre-heater to warm the incoming air to protect the heat exchangers from freezing

2. Constant Pressure Pack

- Differential pressure and flow measurement for energy optimisation

3. Hygiene Pack

- Inclined tube manometers to maintain the certified hygiene standard VDI 6022

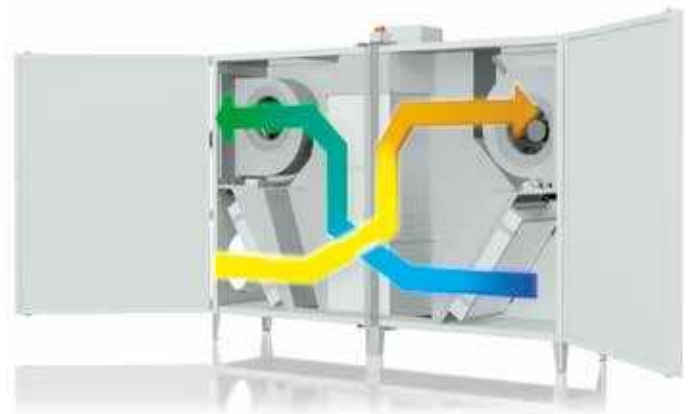

Duplexvent Flexi

Heat Recovery Ventilation

TECHNICAL DATA

OPERATING MODES

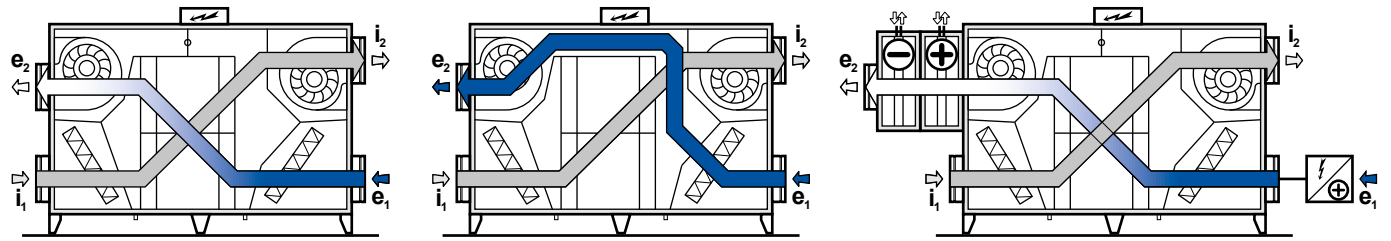

1. Equal pressure ventilation with heat recovery

2. Equal pressure ventilation without heat recovery (through by-pass)

3. Equal pressure ventilation with heating / cooling / or preheating

- ➔ e₁ ...outdoor air (ODA)
- ➔ i₁ ...extract air (ETA)
- ➔ e₂ ...supply air (SUP)
- ➔ i₂ ...extract air (EHA)

Duplexvent Flexi		DV650	DV1100	DV1600	DV2600	DV3600
Nominal Airflow	m ³ /h / l/s	650 / 181	1000 / 278	1500 / 417	2500 / 694	3500 / 972
Nominal external static pressure	Pa	170	230	280	260	250
Power input at nominal operating point	W	320	696	893	1732	2535
Heat recovery efficiency	%			see curve		
Fan type		EC (backward curved impeller)				
Weight ¹	kg	148	150	205	280	370
Fan number	-	2	2	2	2	2
Power supply	V	230	230	230	230	400
Frequency	Hz	50	50	50	50	50
Max. power input	W	340	780	1030	1760	2980
Fan speed	min ⁻¹	4300	3400	2430	2200	2100
Filtration class	-	ePM2.5 65% (F7) ePM10 70% (M5)	ePM2.5 65% (F7) ePM10 70% (M5)	ePM2.5 65% (F7) ePM10 70% (M5)	ePM2.5 65% (F7) ePM10 70% (M5)	ePM2.5 65% (F7) ePM10 70% (M5)
Part No.	-	90001062	90000183	90000068	90000069	90000070

1. Depending on equipment

PERFORMANCE

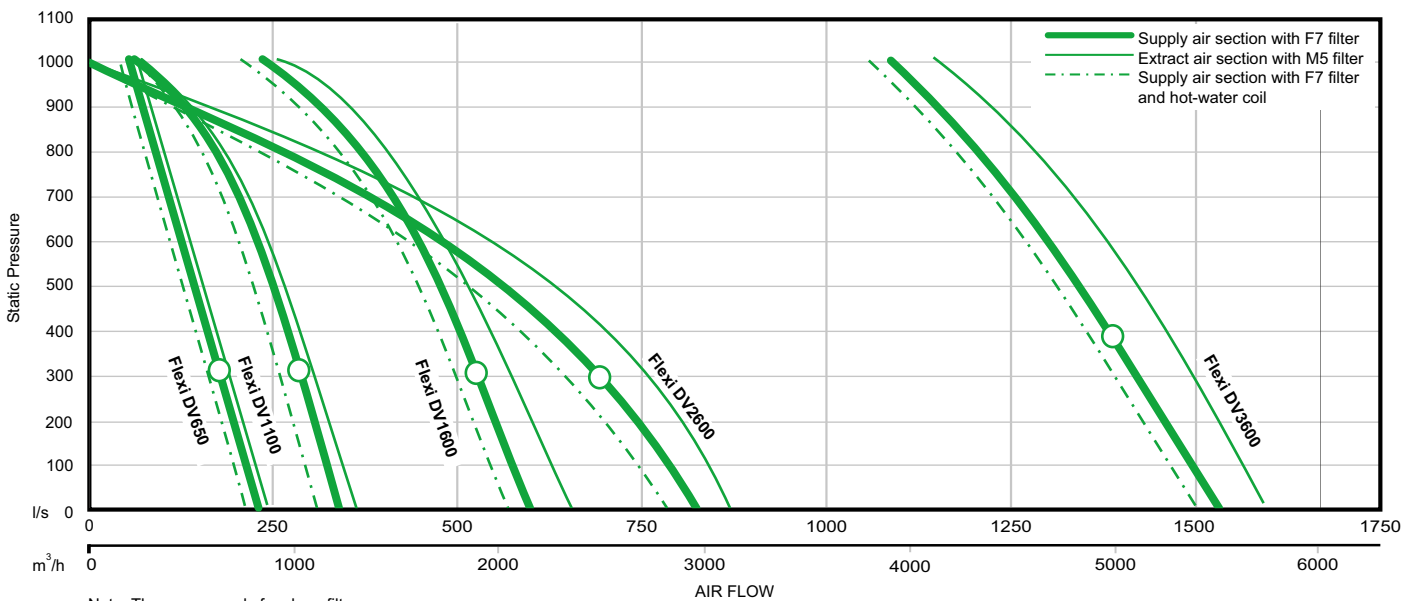

Note: The curves apply for clean filters;
dirty filter pressure loss is considered at 200 Pa or at an air flow reduction of max. 20% [in accord. en 13053]

HEATING AND COOLING CAPACITY

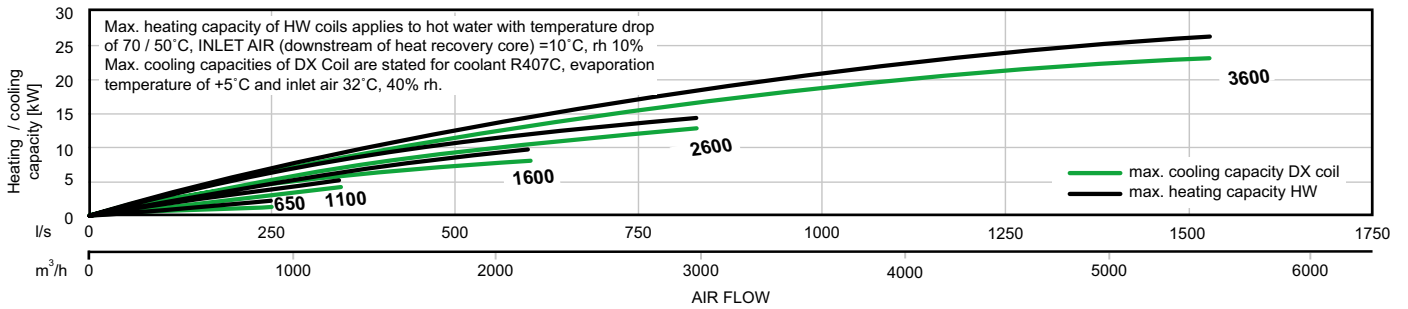

HEAT RECOVERY EFFICIENCY

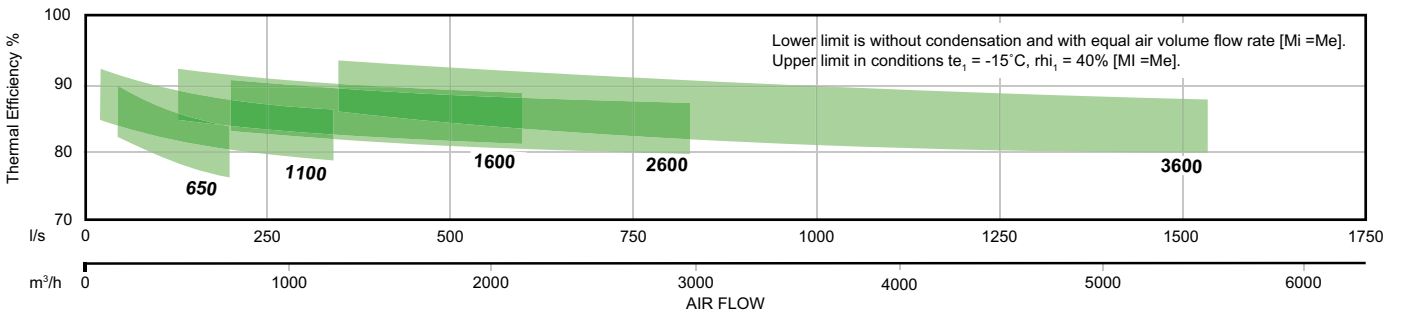

CONNECTION PORTS

Basic port
 (inlet, outlet)

Port with a flexible connection
 (inlet, outlet delivered separately)

Port with a damper
 (inlet only; delivered separately)

Port with a damper and flexible connection
 (inlet only; delivered separately)

ROUND CONNECTION PORTS (DV1100, DV1600)

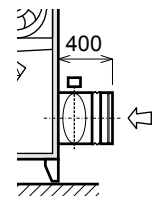
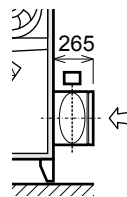
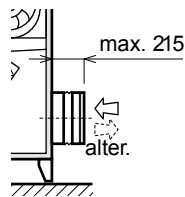
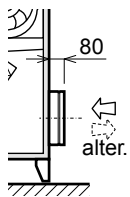

RECTANGULAR CONNECTION PORTS (DV650, DV2600, DV3600)

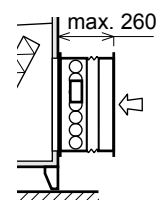
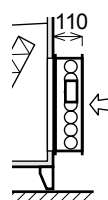
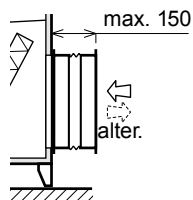
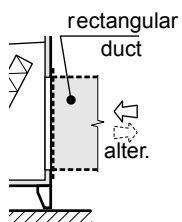

Note: For detailed design and technical data we recommend using our dedicated selection software.

Duplexvent Flexi

Heat Recovery Ventilation

INSTALLATION CONFIGURATION

DUPLEXVENT FLEXI INSTALLATION POSITIONS AND PORT CONFIGURATIONS

The units are available in multipurpose design, allowing the unit to be installed on the floor or beneath the ceiling. For both the floor and ceiling-suspended installation, the standard support steel legs are used. Cooling coils must always be suspended separately. Cooling coils also have their own condensate drain and during installation the respective drain must be chosen. All drains must be connected to a sewer. In addition, unit sides can be interchanged, i.e. supply and exhaust air ports can be used conversely. This ensures high installation flexibility on site.

Hot water heating coil and / or a water-based or direct cooling coil (to be fitted directly on to the unit) or an electric heating coil

(to be installed in to the duct) may be optionally connected to the unit.

Note: The cooling coils may not be fitted to units with spigots in upward position e_2 .

In addition the Duplexvent Flexi DV1600 unit includes alternative ports (e_2 and i_2) that can be interchanged on site and used as top ports. For a detailed unit design we recommend a Duplexvent selection software be used; available at www.airflow.com

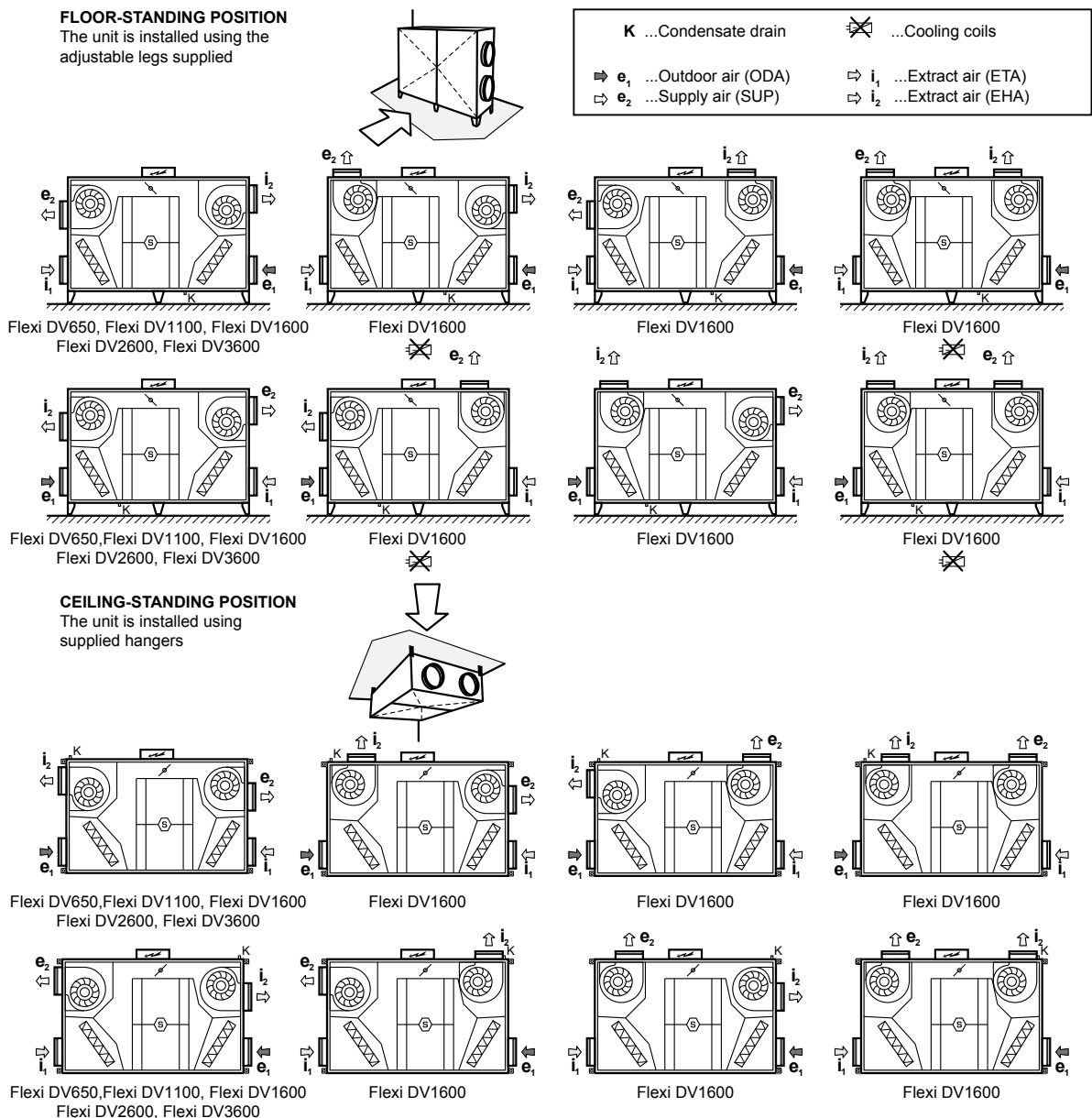

MANIPULATION SPACE

DUPLEXVENT FLEXI MANIPULATION SPACE

When installing Duplexvent Flexi units it is necessary to allow for the recommended free space around the unit for manipulation. A minimum space of 150 mm is needed under the unit to install a DN 32 condensate drain pipe. A trap with a minimum height of 150 mm must be installed before connecting the pipe to a building sewer. The recommended space is easily ensured when the standard support steel legs are used.

Space in front of the unit is required for opening the door, filter changing and access to all components that require service.

Minimum manipulation space required for the hinged door is marked on respective drawings. For all units 600 mm free manipulation space from an electric control panel is required in accordance with respective standards.

MANIPULATION SPACE, UNIT CONFIGURATION

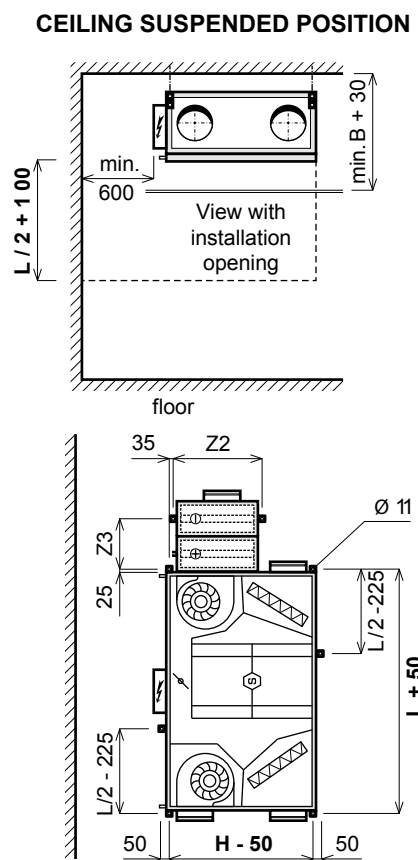
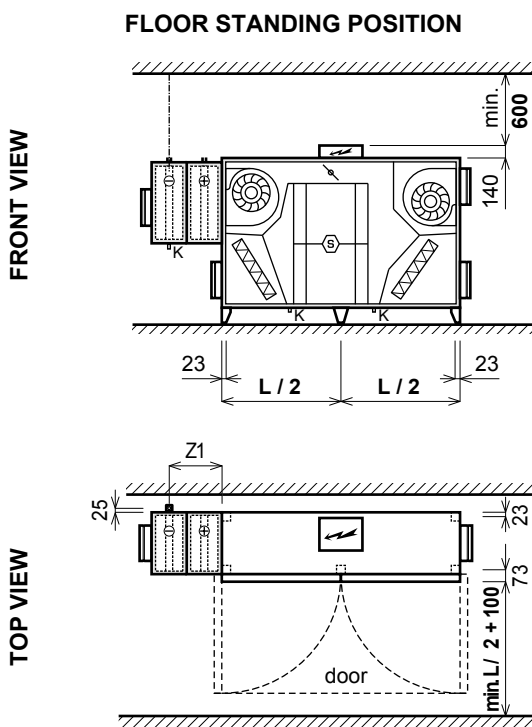

Duplexvent Flexi	Support legs	Suspension point - Cooling Coil	Suspension point - Unit	Suspension point - Cooling Coil
DV650	4 pcs	1 pc	4 pcs (in corners)	2 pcs
DV1100	4 pcs	1 pc	4 pcs (in corners)	2 pcs
DV1600	5 pcs	1 pc	4 pcs (in corners)	2 pcs
DV2600	6 pcs	1 pc	4 pcs (in corners)	2 pcs
DV3600	6 pcs	1 pc	6 pcs (in corners and in the middle)	2 pcs

Duplexvent Flexi	L	Z1	Z2	Z3	B	H
DV650	1370	355	650	355	298	1100
DV1100	1700	418	625	392	395	1100
DV1600	2020	418	750	392	490	1270
DV2600	2150	566	875	540	570	1570
DV3600	2450	625	875	600	780	1660

Duplexvent Flexi DV650

Flexi Line Side Entry



KEY FEATURES

- Air volume up to 650 m³/h at 170 Pa according to ErP 2018
- Excellent thermal efficiency, up to 90%
- Versatile unit positioning with floor and ceiling mounting options
- Low SFP with energy saving EC fans
- Low noise, refer to NR35 and BB93 standards
- Excellent thermal insulation (class T2, TB1)
- 100% adjustable digital controller with Internet and BMS connection
- BREEAM, Passive House and ErP 2018 compliant
- 2 year warranty+

PERFORMANCE

Ventilation		Supply Air	Extract Air
Air volume @ 200 Pa	m ³ /hr / l/sec	650 / 181	650 / 181
Nominal voltage	V	230	230
Nominal power (at operation point)	kW	0.17	0.15
Fan Speed	RPM	4300	4300
Max power input	kW	0.167	0.147
Max current	A	1.31	1.14
Fan Type		EC	EC

Note: The figures above have been measured at 650 m³/h and 170 Pa. Please use the Duplexvent Selection Software to calculate measurements at other performance levels

AIR FLOW CURVE

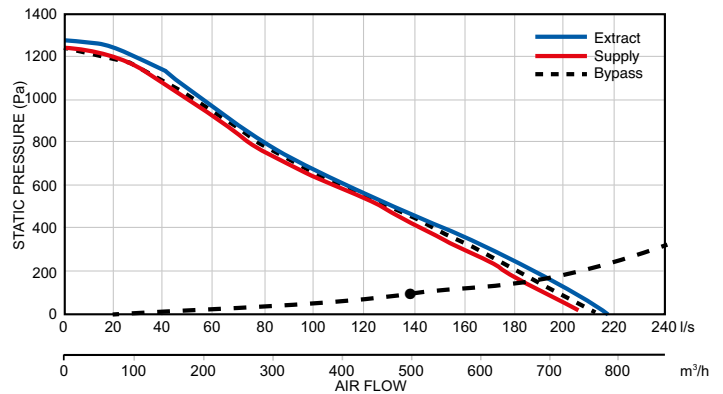

Heat Recovery		Supply Air	Extract Air
Air volume @ 200 Pa	m ³ /hr / l/sec	650 / 181	650 / 181
Temperature at inlet	°C	-5	20
Temperature at outlet	°C	15	3
Humidity at inlet	% RH	90	40
Humidity at outlet	% RH	21	100
Heat recovery efficiency winter / summer	%	80 / 75.8	
Performance in winter / summer	kW	4.5 / 1	
Condensation	l/h	0.9	
Type of heat exchanger		Cross-counter-flow, Plastic	
Part No.		90001062	

Note: The figures above have been measured at 650 m³/h and 170 Pa. Please use the Duplexvent Selection Software to calculate measurements at other performance levels

POWER CONSUMPTION

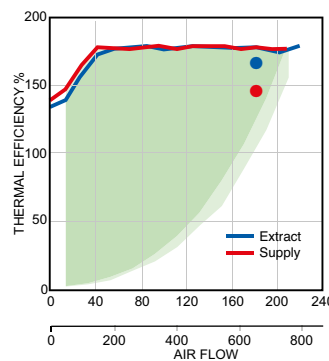

Note: Green area denotes power consumption range. Power consumption depends on system installation.

HEAT RECOVERY EFFICIENCY

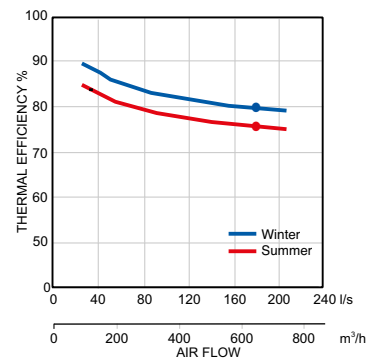

+excludes motors. Motor warranty one year from date of purchase.

Sound Power Level L _w	Total	63 Hz	125 Hz	250 Hz	500 Hz	1 kHz	2 kHz	4 kHz	8 kHz
	dB (A)								
Outdoor air e1	56	43	43	42	53	50	49	36	28
Supply air e2	80	53	59	66	74	73	74	70	71
Extract air i1	55	45	46	43	48	50	46	34	30
Exhaust air i2	79	53	59	65	73	71	72	69	70
Breakout noise	56	29	34	45	53	49	45	35	<25
Sound Pressure Level L _p measured at 3m	35	<25	<25	25	33	28	25	<25	<25

Note: The figures above have been measured at 650 m³/h and 170 Pa. Please use the Duplexvent Selection Software to calculate measurements at other performance levels



2018

Winter Operation:

e1 - outdoor air (ODA) i1 - extract air (ETA)
e2 - supply air (SUP) i2 - exhaust air (EHA)

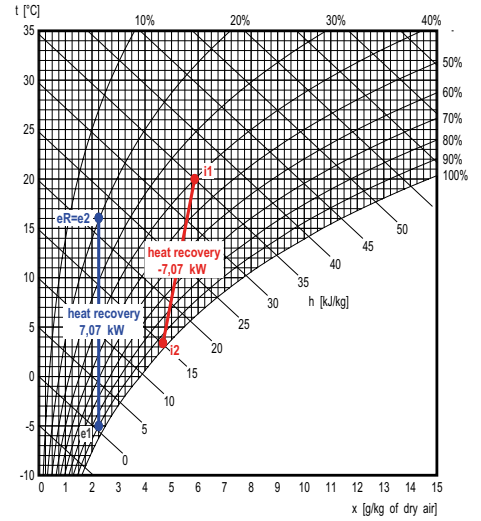
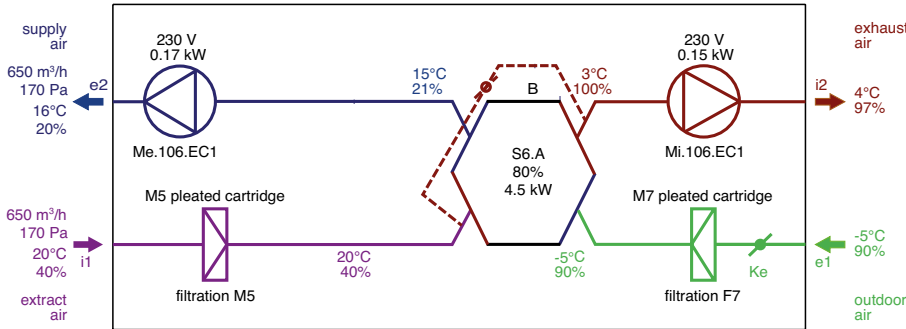

Supply

	Description	t [°C]	RH [%]
e1	Outdoor Air	-5.0	90
e2	Supply Air	15.6	20

Exhaust

	Description	t [°C]	RH [%]
i1	Extract Air	20.0	40
i2	Exhaust Air	3.5	97

Summer Operation:

e1 - outdoor air (ODA) i1 - extract air (ETA)
e2 - supply air (SUP) i2 - exhaust air (EHA)

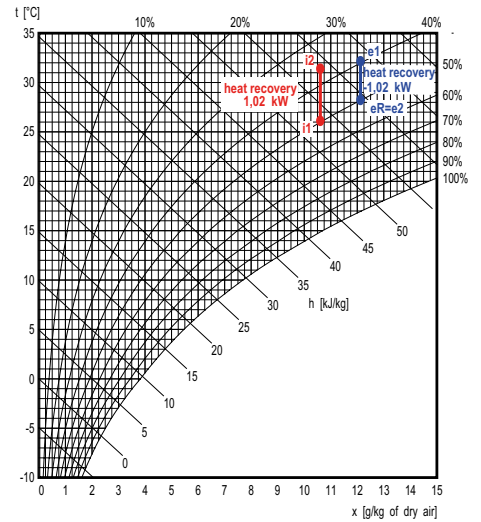
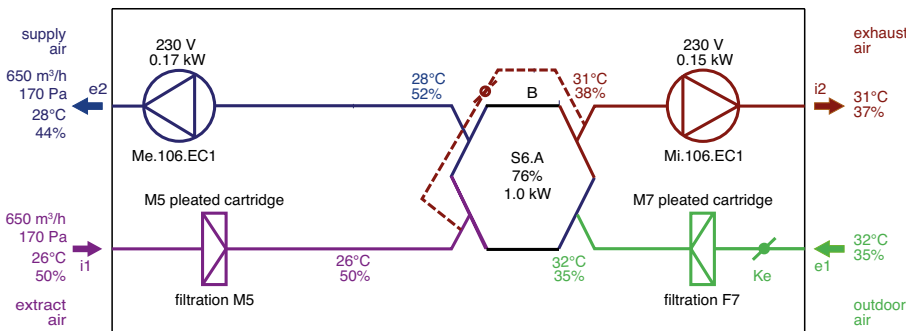

Supply

	Description	t [°C]	RH [%]
e1	Outdoor Air	32.0	35
e2	Supply Air	28.1	44

Exhaust

	Description	t [°C]	RH [%]
i1	Extract Air	26.0	50
i2	Exhaust Air	31	37

FILTERS

Filtration		Supply	Extract	Accessories (part of delivery)
Type		Pleated Cartridge		Pfe dirty filter pressure switch for supply air Pfi dirty filter pressure switch for extract air
Filtration class		ePM2.5 65% (F7)	ePM10 70% (M5)	
Number of filters	pcs	1	1	
Filter cartridge size	mm	500x235x48	500x235x48	

Duplexvent Flexi DV650

Flexi Line Side Entry

OPTIONAL ACCESSORIES

ELECTRIC PRE-HEATER

Electric pre-heater		Supply
Air volume	m ³ /h / l/s	650 / 181
Maximum heating capacity	kW	2.0
Voltage	V	230
Connection ports	mm	Ø 200

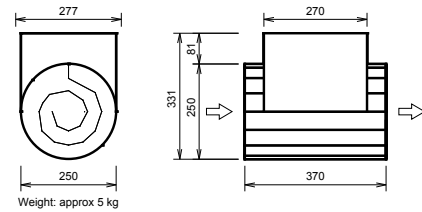

WATER HEATING COIL

Water heating coil		Supply
Heating medium		Water
Air volume	m ³ /h / l/s	650 / 181
Temperature at inlet (after heat recovery)	°C	24.7
Temperature at outlet (downstream of the heater)	°C	22.4
Heating capacity	kW	1
Heating medium temperature drop	°C	70/50
Medium flow (from source)	l/h	43
Connection dimension (hydraulic kit)		1" female

Note: The figures above have been measured at 650 m³/hr and 170 Pa. Please use the Duplexvent Selection Software to calculate measurements at other performance levels.

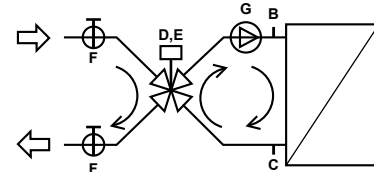

- B Sludge valve plug 2)
 - C Sludge valve plug 2)
 - Hydraulic kit: RE-HW4.LM24A-SR
 - D Mixing valve IVAR.MIX4, Kv 12, 1" 1)
 - E Actuator LM24A-SR 1)
 - F Globe valve 1" female 1)
 - G Pump WILO YONOS PARA RS 20/6- RKC 1)
- 1 - Delivered separately
2 - Fitted and connected

HEATING CAPACITY

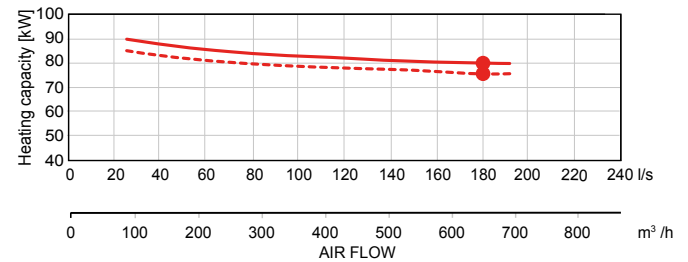

WATER COOLING COIL

Water cooling coil		Supply
Cooling medium		21% Ethylene glycol
Air volume	m ³ /h / l/s	650 / 181
Temperature at inlet (after heat recovery)	°C	28.1
Temperature at outlet (downstream of the cooling coil)	°C	18.4
Inlet relative humidity (after heat recovery)	% RH	44
Outlet relative humidity (downstream of the cooling coil)	% RH	79.1
Cooling capacity	kW	2.12
Condensate production	l/h	0.1
Water temperature drop	°C	6 / 12
Medium flow (at max. capacity)	l/h	320
Medium-side pressure drop		
in heat exchanger	kPa	2.9
in valve	kPa	0.1
Connection dimension		1" female

Note: The figures above have been measured at 650 m³/hr and 170 Pa. Please use the Duplexvent Selection Software to calculate measurements at other performance levels.

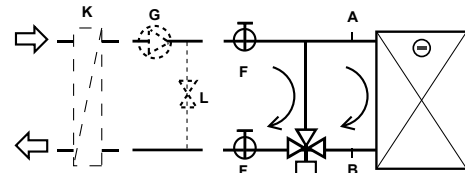

- B Sludge valve plug 2)
 - Hydraulic kit: R-CW3.TR 24-SR
 - D 3-way ball valve R320BM, Kv 21, ¾" 1)
 - E Actuator TR 24-SR 1)
 - F Globe valve 1" female 1)
- Others:
- G Pump 3)
 - L Water bypass 3)
 - K Coil water/ethylene glycol 3)
- 1 - Delivered separately
2 - Fitted and connected
3 - Not part of delivery

COOLING CAPACITY

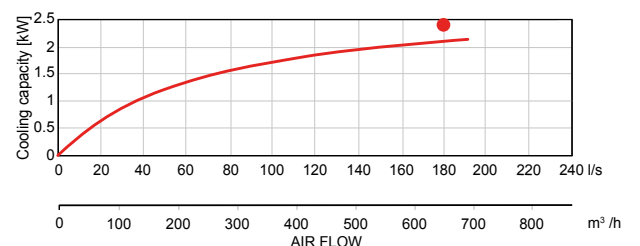

DX COIL

DX coil		Supply
Air volume	m ³ /h / l/s	650 / 181
Temperature at inlet (after heat recovery)	°C	28
Temperature at outlet (downstream of the DX coil)	°C	17
Inlet relative humidity (after heat recovery)	% RH	44
Outlet relative humidity (downstream of the DX coil)	% RH	86
Cooling capacity	kW	2.4
Condensate production	l/h	0.2
Refrigerant type		R410A
Evaporating temperature	°C	6

Note: The figures above have been measured at 650 m³/hr and 170 Pa. Please use the Duplexvent Selection Software to calculate measurements at other performance levels.

COOLING CAPACITY

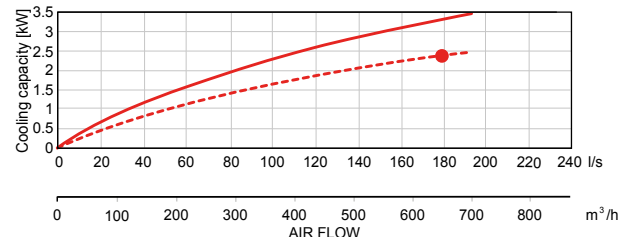

DIMENSIONS

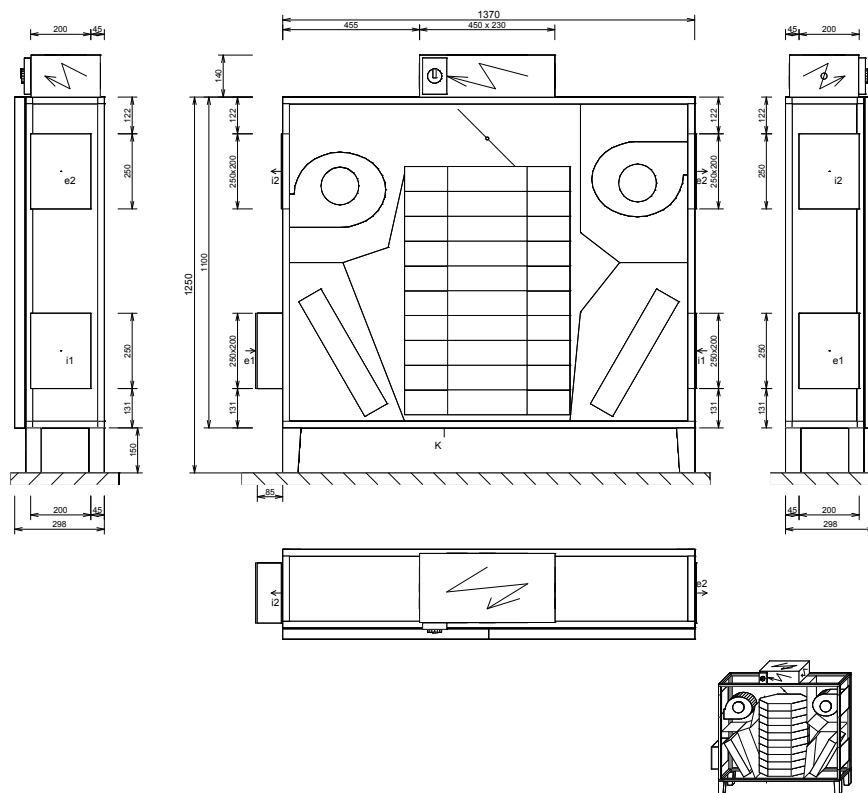

Connections	Type	Dimensions	Optional components
e1	e1- outdoor air (ODA)	250 x 200 mm	Shutoff damper, Flexible connection
e2	e2- supply air (SUP)	250 x 200 mm	Flexible connection
i1	i1- extract air (ETA)	250 x 200 mm	Shutoff damper, Flexible connection
i2	i2- exhaust air (EHA)	250 x 200 mm	Flexible connection
K	condensate drain	2x Ø 16 mm / 22 mm	Condensate pump

Notice:

- Unit supplied as one piece
- Door – 2 parts
- Diagram is intended only for basic information, binding dimensions receive at device delivery, or on request from the manufacturer.

Duplexvent Flexi DV1100

Flexi Line Side Entry



PERFORMANCE

Ventilation		Supply Air	Extract Air
Air volume @ 200 Pa	m ³ /h / l/s	1000 / 278	1000 / 278
Nominal voltage	V	230	230
Nominal power (at operation point)	kW	0.29	0.28
Fan Speed	min ⁻¹	3113	3108
Max power input	kW	0.39	0.39
Max current	A	2.5	2.5
Fan Type		EC	EC

Note: The figures above have been measured at 1000 m³/h and 200 Pa. Please use the Duplexvent Selection Software to calculate measurements at other performance levels

Heat Recovery		Supply Air	Extract Air
Air volume @ 200 Pa	m ³ /h / l/s	1000 / 278	1000 / 278
Temperature at inlet	°C	-5	20
Temperature at outlet	°C	16.1	3.4
Humidity at inlet	% RH	90	40
Humidity at outlet	% RH	20	96
Heat recovery efficiency winter / summer	%	82 / 78	
Performance in winter / summer	kW	7.1 / 1.6	
Condensation	l/h	1.5	
Type of heat exchanger		Cross-counter-flow, Plastic	
Part No.		90000183	

Note: The figures above have been measured at 1000 m³/h and 200 Pa. Please use the Duplexvent Selection Software to calculate measurements at other performance levels.

Sound Power Level L _w	Total	63 Hz	125 Hz	250 Hz	500 Hz	1 kHz	2 kHz	4 kHz	8 kHz
	dB (A)								
Outdoor air e1	59	39	44	49	57	50	44	29	<25
Supply air e2	81	52	62	74	77	75	73	66	64
Extract air i1	62	45	45	54	60	52	44	30	<25
Exhaust air i2	81	55	64	74	76	75	73	67	65
Breakout noise	62	38	43	53	59	53	52	49	39
Sound Pressure Level L _p measured at 3m	41	<25	<25	33	38	32	32	28	<25

Note: The figures above have been measured at 1000 m³/h and 200 Pa. Please use the Duplexvent Selection Software to calculate measurements at other performance levels.

KEY FEATURES

- Air volume up to 1000 m³/h at 200 Pa according to ErP 2018
- Excellent thermal efficiency, up to 92%
- Versatile unit positioning with floor and ceiling mounting options
- Low SFP with energy saving EC fans
- Low noise, refer to NR35 and BB93 standards
- Excellent thermal insulation (class T2, TB1)
- 100% adjustable digital controller with Internet and BMS connection
- BREEAM, Passive House and ErP 2018 compliant
- 2 year warranty +

AIR FLOW CURVE

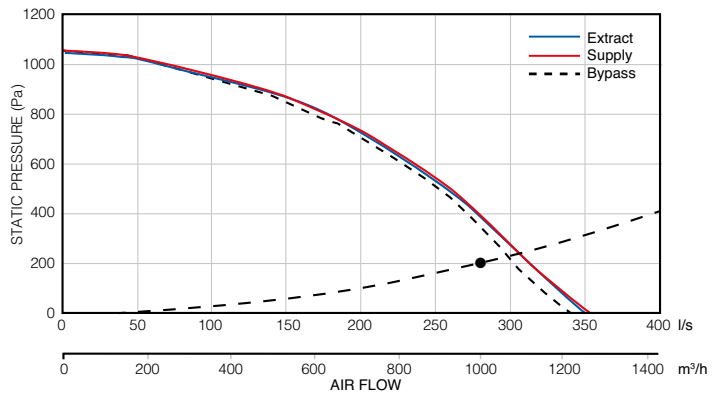

POWER CONSUMPTION

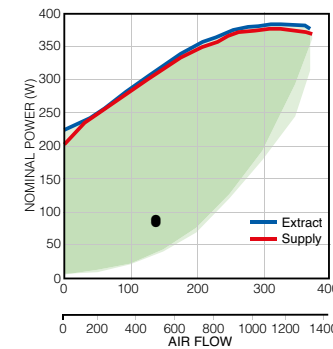

Note: Green area denotes power consumption range. Power consumption depends on system installation.

+excludes motors. Motor warranty one year from date of purchase.

HEAT RECOVERY EFFICIENCY

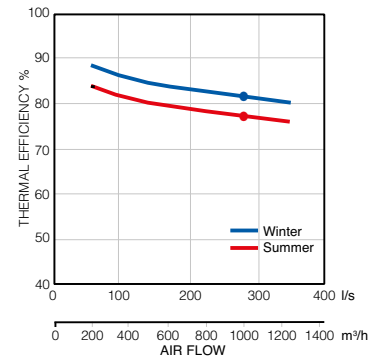



2018

Winter Operation:

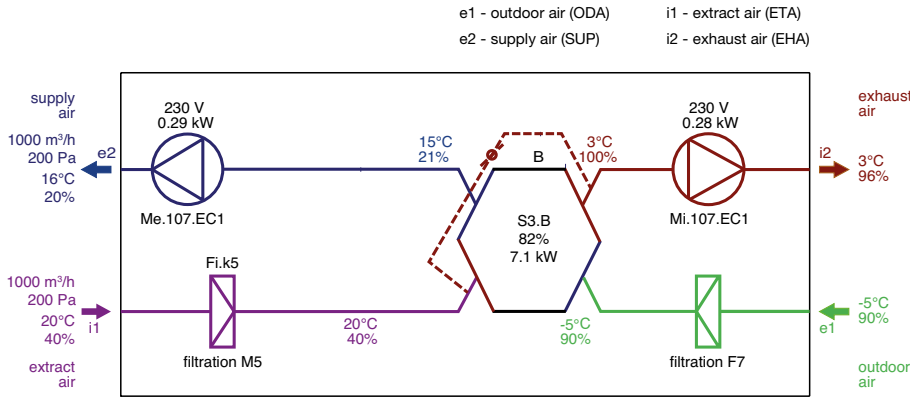

Note: AHU functions diagram. Inlet and outlet location may differ from actual position and port configuration.

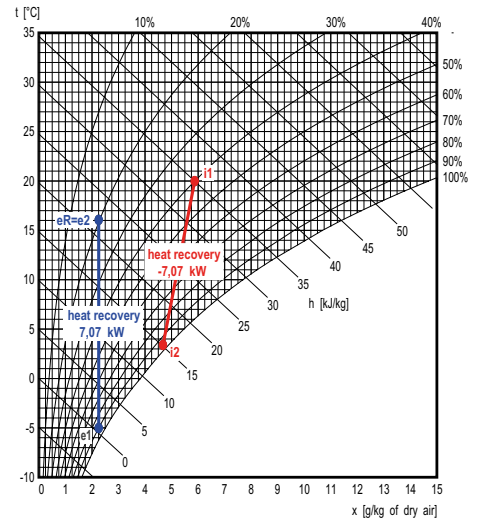

Supply

	Description	t [°C]	RH [%]
e1	Outdoor Air	-5.0	90
e2	Supply Air	16.1	20

Exhaust

	Description	t [°C]	RH [%]
i1	Extract Air	20.0	40
i2	Exhaust Air	3.4	96

Summer Operation:

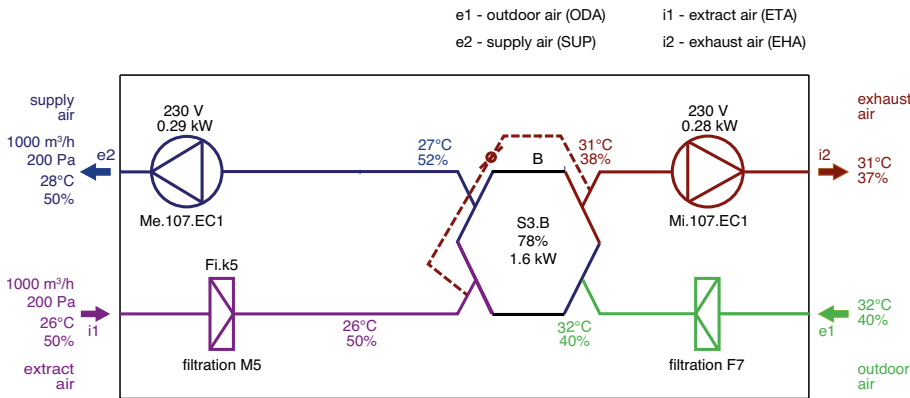

Note: AHU functions diagram. Inlet and outlet location may differ from actual position and port configuration.

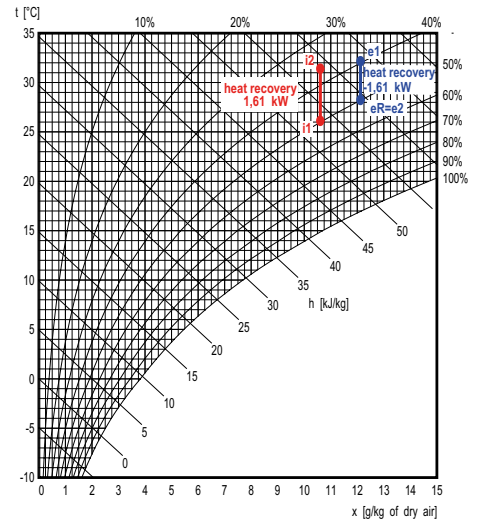

Supply

	Description	t [°C]	RH [%]
e1	Outdoor Air	32.0	40
e2	Supply Air	28.1	50

Exhaust

	Description	t [°C]	RH [%]
i1	Extract Air	26.0	50
i2	Exhaust Air	31.3	37

FILTERS

Filtration	Supply	Extract	Accessories (part of delivery)
Type	Pleated Cartridge		Pfe dirty filter pressure switch for supply air Pfi dirty filter pressure switch for extract air
Filtration class	ePM2,5 65 % (F7)	ePM10 70 % (M5)	
Number of filters	pcs 1	1	
Filter cartridge size	mm 440x310x96	440x310x96	

Duplexvent Flexi DV1100

Flexi Line Side Entry

OPTIONAL ACCESSORIES

ELECTRIC PRE-HEATER

Electric pre-heater		Supply
Air volume	m ³ /h / l/s	1000 / 278
Maximum heating capacity	kW	3.0
Voltage	V	400
Connection ports	mm	Ø 250

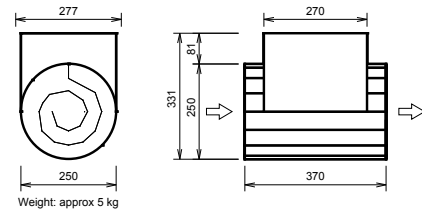

WATER HEATING COIL

Water heating coil		Supply
Heating medium		Water
Air volume	m ³ /h / l/s	1000 / 278
Temperature at inlet (after heat recovery)	°C	16
Temperature at outlet (downstream of the heater)	°C	20
Heating capacity	kW	1.3
Heating medium temperature drop	°C	70/50
Medium flow (from source)	l/h	57
Connection dimension (hydraulic kit)		1" female

Note: The figures above have been measured at 1000 m³/h and 200 Pa. Please use the Duplexvent Selection Software to calculate measurements at other performance levels.

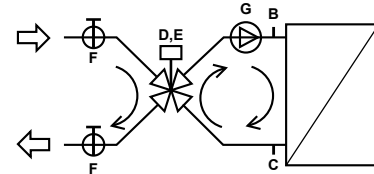

- B Sludge valve plug 2)
 - C Sludge valve plug 2)
 - Hydraulic kit: RE-HW4.LM24A-SR
 - D Mixing valve IVAR.MIX4, Kv 12, 1" 1)
 - E Actuator LM24A-SR 1)
 - F Globe valve 1" 1)
 - G Pump 1)
- WILO YONOS PARA RS 20/6- RKC
- 1 - Delivered separately
2 - Fitted and connected

HEATING CAPACITY

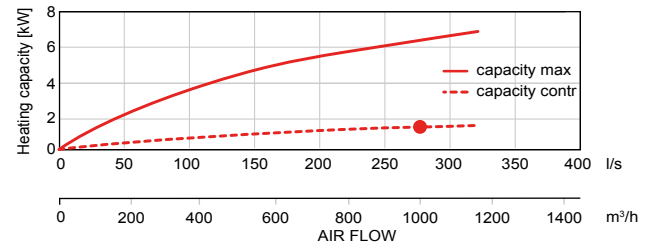

WATER COOLING COIL

Water cooling coil		Supply
Cooling medium		21% Ethylene glycol
Air volume	m ³ /h / l/s	1000 / 278
Temperature at inlet (after heat recovery)	°C	28
Temperature at outlet (downstream of the cooling coil)	°C	18
Inlet relative humidity (after heat recovery)	% RH	50
Outlet relative humidity (downstream of the cooling coil)	% RH	83
Cooling capacity	kW	5.1
Condensate production	l/h	2
Water temperature drop	°C	6 / 12
Medium flow (at max. capacity)	l/h	770
Medium-side pressure drop		
in heat exchanger	kPa	106.14
in valve	kPa	0.6
Connection dimension		1" female

Note: The figures above have been measured at 1000 m³/h and 200 Pa. Please use the Duplexvent Selection Software to calculate measurements at other performance levels.

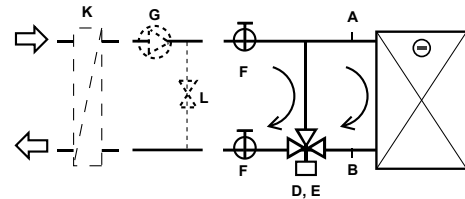

- A, B Sludge valve plug 2)
 - Hydraulic kit: R-CW3.TR 24-SR
 - D 3-way ball valve R320BM, Kv 21, ¾" 1)
 - E Actuator TR 24-SR 1)
 - F Globe valve 1" 1)
 - Others:
 - G Pump 3)
 - L Water bypass 3)
 - K Coil water/ethylene glycol 3)
- 1 - Delivered separately
2 - Fitted and connected
3 - Not part of delivery

COOLING CAPACITY

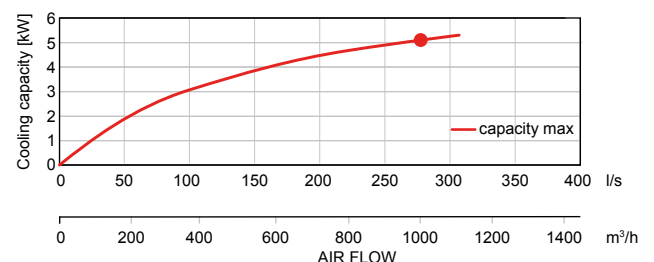

DX COIL

DX coil	Supply	
Air volume	m ³ /h / l/s	1000 / 278
Temperature at inlet (after heat recovery)	°C	28
Temperature at outlet (downstream of the DX coil)	°C	17
Inlet relative humidity (after heat recovery)	% RH	50
Outlet relative humidity (downstream of the DX coil)	% RH	81
Cooling capacity	kW	5.13
Condensate production	l/h	3
Refrigerant type		R410A
Evaporating temperature	°C	5

Note: The figures above have been measured at 1000 m³/h and 200 Pa. Please use the Duplexvent Selection Software to calculate measurements at other performance levels.

COOLING CAPACITY

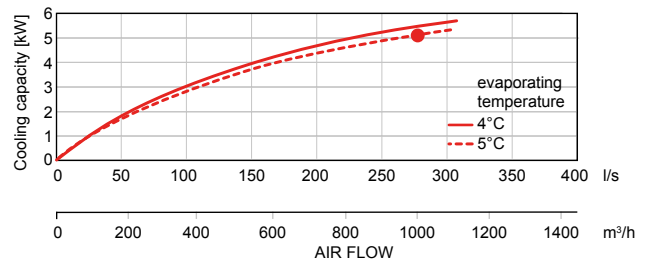

DIMENSIONS

Versatile position (floor standing)
Weight: approx. 193 kg

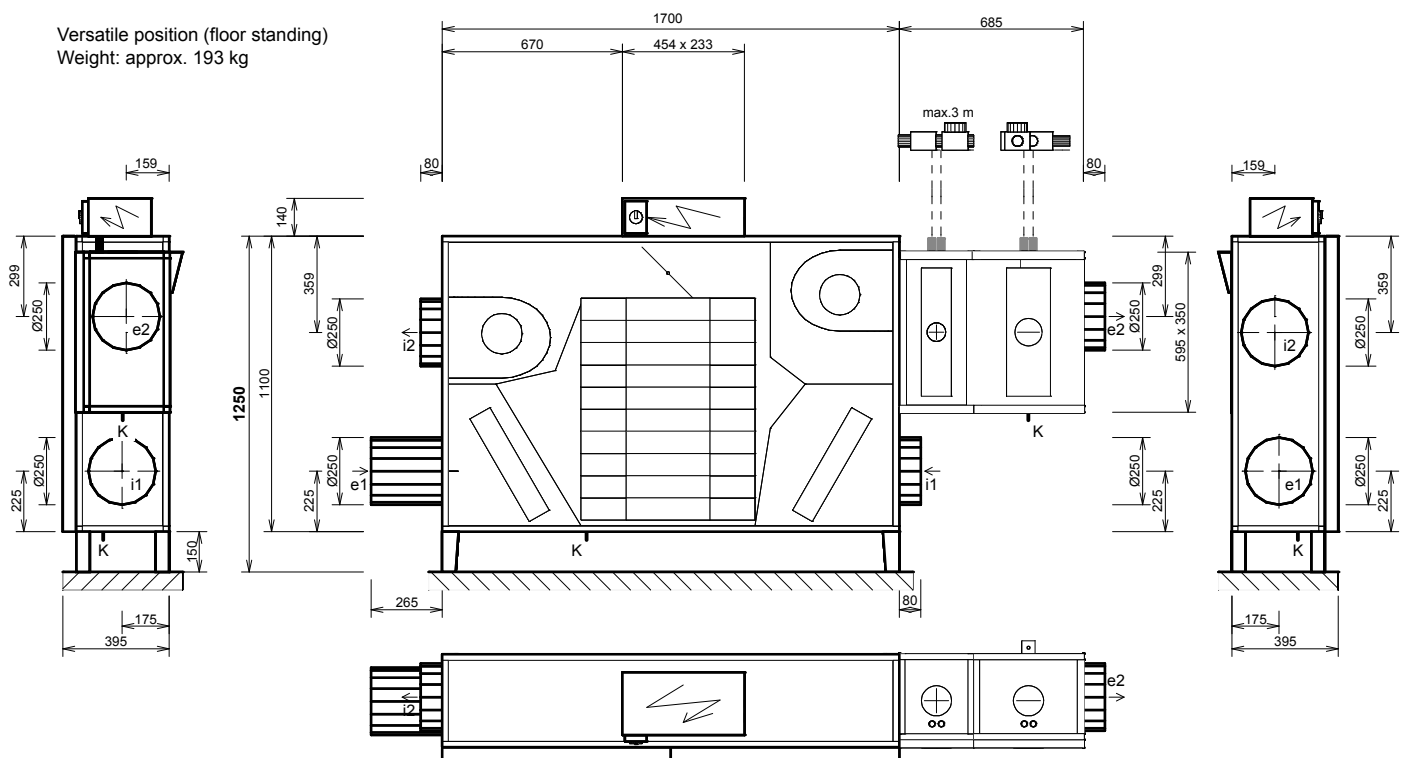

Connections	Type	Dimensions	Optional components
e1	e1- outdoor air (ODA)	Ø 250 mm	Shutoff damper, Flexible connection
e2	e2- supply air (SUP)	Ø 250 mm	Flexible connection
i1	i1- extract air (ETA)	Ø 250 mm	Shutoff damper, Flexible connection
i2	i2- exhaust air (EHA)	Ø 250 mm	Flexible connection
K	condensate drain	2x Ø 16 mm / 22 mm	Condensate pump

Notice:

- Unit supplied as one piece
- Door – 2 parts
- Diagram is intended only for basic information, binding dimensions receive at device delivery, or on request from the manufacturer.

Duplexvent Flexi DV1600

Flexi Line Side / Top Entry



KEY FEATURES

- Air volume up to 1650 m³/h at 200 Pa according to ErP 2018
- Excellent thermal efficiency, up to 92%
- Versatile unit positioning with floor and ceiling mounting options
- Low SFP with energy saving EC fans
- Low noise, refer to NR35 and BB93 standards
- Excellent thermal insulation (class T2, TB1)
- 100% adjustable digital controller with Internet and BMS connection
- BREEAM, Passive House and ErP 2018 compliant
- 2 year warranty +

PERFORMANCE

Ventilation		Supply Air	Extract Air
Air volume @ 200 Pa	m ³ /h / l/s	1500 / 417	1500 / 417
Nominal voltage	V	230	230
Nominal power (at operation point)	kW	0.39	0.32
Fan Speed	min ⁻¹	2396	2257
Max power input	kW	0.78	0.78
Max current	A	3.9	3.9
Fan Type		EC	EC

Note: The figures above have been measured at 1500 m³/h and 200 Pa. Please use the Duplexvent Selection Software to calculate measurements at other performance levels.

AIR FLOW CURVE

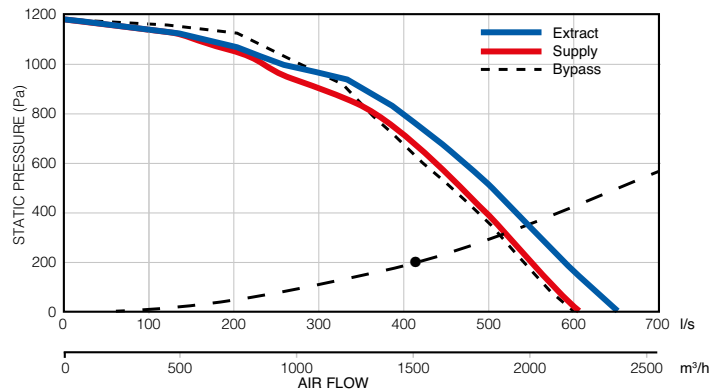

Heat Recovery		Supply Air	Extract Air
Air volume @ 200 Pa	m ³ /h / l/s	1500 / 417	1500 / 417
Temperature at inlet	°C	-5	20
Temperature at outlet	°C	17	2.7
Humidity at inlet	% RH	90	40
Humidity at outlet	% RH	19	97
Heat recovery efficiency winter / summer	%	86 / 81	
Performance in winter / summer	kW	11.1 / 2.5	
Condensation	l/h	2.5	
Type of heat exchanger		Cross-counter-flow, Plastic	
Part No.		90000068	

Note: The figures above have been measured at 1500 m³/h and 200 Pa. Please use the Duplexvent Selection Software to calculate measurements at other performance levels.

POWER CONSUMPTION

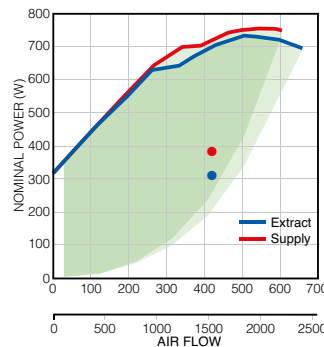

Note: Green area denotes power consumption range. Power consumption depends on system installation.

HEAT RECOVERY EFFICIENCY

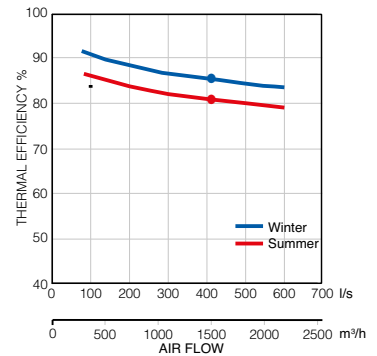

+excludes motors. Motor warranty one year from date of purchase.

Sound Power Level L _w	Total	63 Hz	125 Hz	250 Hz	500 Hz	1 kHz	2 kHz	4 kHz	8 kHz
	dB (A)								
Outdoor air e1	55	35	41	52	47	47	36	29	<25
Supply air e2	79	55	62	74	75	72	68	66	64
Extract air i1	59	38	46	57	49	52	39	30	<25
Exhaust air i2	82	55	64	80	76	74	69	67	65
Breakout noise	61	45	47	59	53	52	49	49	39
Sound Pressure Level L _p measured at 3m	41	<25	27	38	32	31	29	28	<25

Note: The figures above have been measured at 1500 m³/h and 200 Pa. Please use the Duplexvent Selection Software to calculate measurements at other performance levels.



2018

Winter Operation:

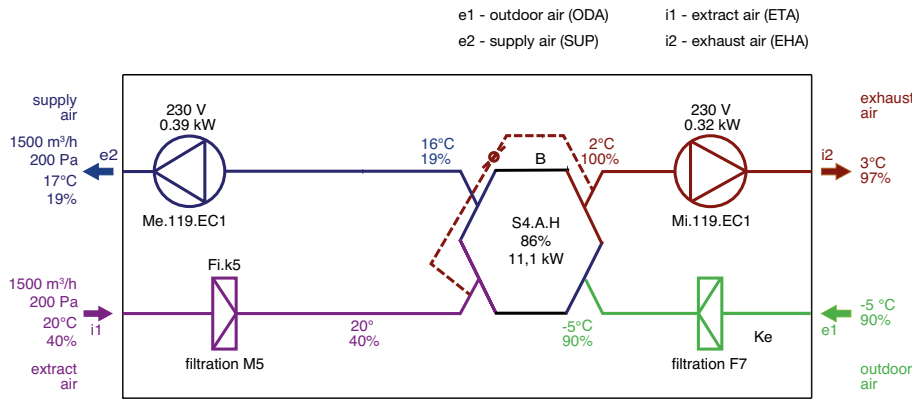

Note: AHU functions diagram. Inlet and outlet location may differ from actual position and port configuration.

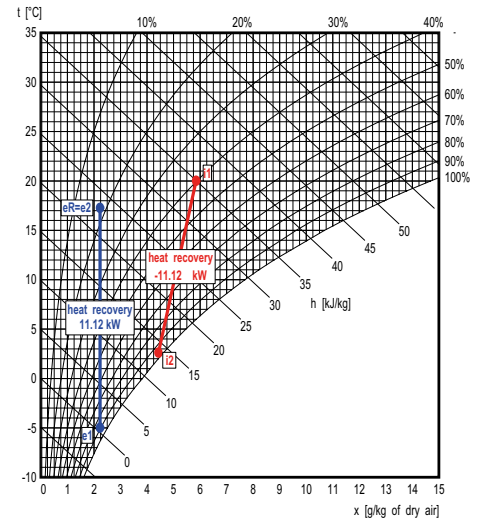

Supply

Description	t [°C]	RH [%]
e1 Outdoor Air	-5.0	90
e2 Supply Air	17	19

Exhaust

Description	t [°C]	RH [%]
i1 Extract Air	20.0	40
i2 Exhaust Air	2.7	97

Summer Operation:

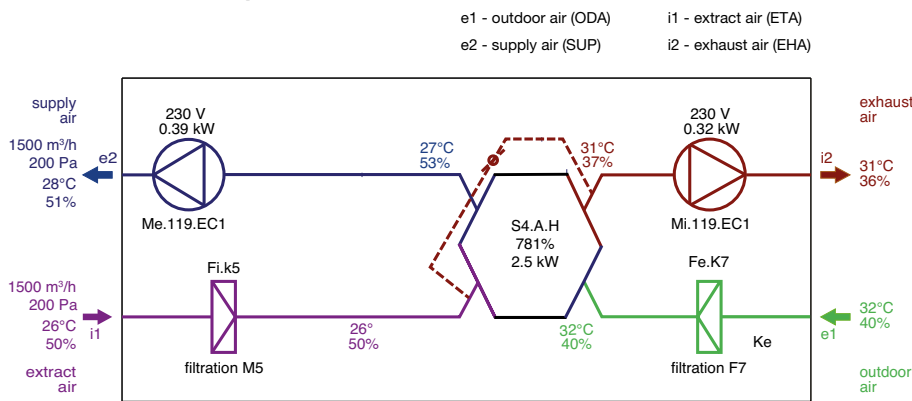

Note: AHU functions diagram. Inlet and outlet location may differ from actual position and port configuration.

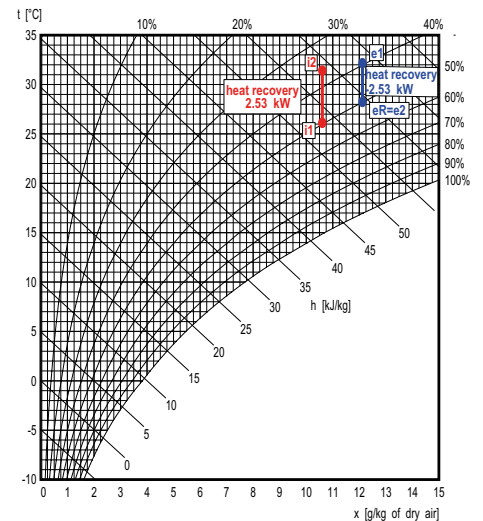

Supply

Description	t [°C]	RH [%]
e1 Outdoor Air	32.0	40
e2 Supply Air	27.8	51

Exhaust

Description	t [°C]	RH [%]
i1 Extract Air	26.0	50
i2 Exhaust Air	31.3	36

FILTERS

Filtration	Supply	Extract	Accessories (part of delivery)
Type	Pleated Cartridge		Pfe dirty filter pressure switch for supply air Pfi dirty filter pressure switch for extract air
Filtration class	F7	M5	
Number of filters	pcs	1	
Filter cartridge size	mm	395x550x96	

Duplexvent Flexi DV1600

Flexi Line Side / Top Entry

OPTIONAL ACCESSORIES

ELECTRIC PRE-HEATER

Electric pre-heater		Supply
Air volume	m ³ /h / l/s	1500 / 417
Maximum heating capacity	kW	6.0
Voltage	V	400
Connection ports	mm	Ø 315

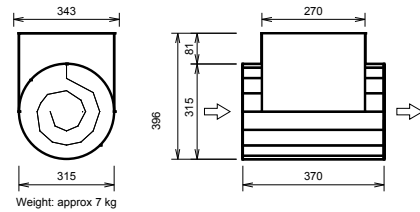

WATER HEATING COIL

Water heating coil		Supply
Heating medium		Water
Air volume	m ³ /h / l/s	1500 / 417
Temperature at inlet (after heat recovery)	°C	17
Temperature at outlet (downstream of the heater)	°C	20
Heating capacity	kW	1.4
Heating medium temperature drop	°C	70/50
Medium flow (from source)	l/h	62
Connection dimension (hydraulic kit)		1" female

Note: The figures above have been measured at 1500 m³/h and 200 Pa. Please use the Duplexvent Selection Software to calculate measurements at other performance levels.

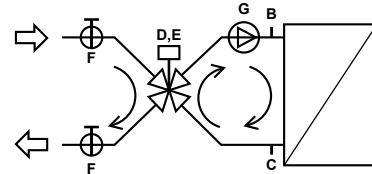

- B Sludge valve plug 2)
 - C Sludge valve plug 2)
 - Hydraulic kit: RE-HW4.LM24A-SR
 - D Mixing valve IVAR.MIX4, Kv 12, 1" 1)
 - E Actuator LM24A-SR 1)
 - F Globe valve 1" 1)
 - G Pump WILO YONOS PARA RS 20/6- RKC 1)
- 1 - Delivered separately
2 - Fitted and connected

HEATING CAPACITY

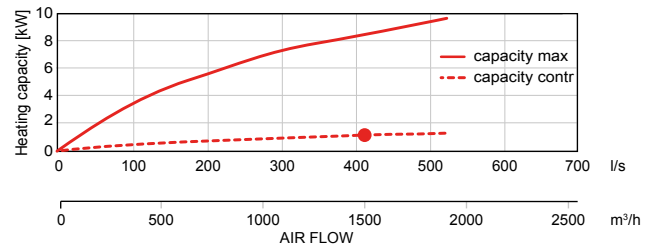

WATER COOLING COIL

Water cooling coil		Supply
Cooling medium		21% Ethylene glycol
Air volume	m ³ /h / l/s	1500 / 417
Temperature at inlet (after heat recovery)	°C	28
Temperature at outlet (downstream of the cooling coil)	°C	18
Inlet relative humidity (after heat recovery)	% RH	51
Outlet relative humidity (downstream of the cooling coil)	% RH	81
Cooling capacity	kW	7.6
Condensate production	l/h	4
Water temperature drop	°C	6 / 12
Medium flow (at max. capacity)	l/h	1210
Medium-side pressure drop		
in heat exchanger	kPa	50.06
in valve	kPa	1.44
Connection dimension		1" female

Note: The figures above have been measured at 1500 m³/h and 200 Pa. Please use the Duplexvent Selection Software to calculate measurements at other performance levels.

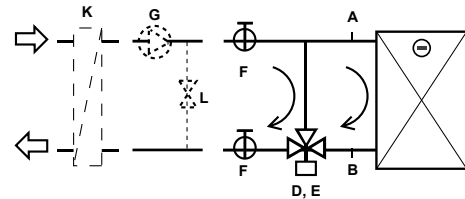

- A,B Sludge valve plug 2)
 - Hydraulic kit: R-CW3.TR 24-SR
 - D 3-way ball valve R320BM, Kv 21, ¾" 1)
 - E Actuator TR 24-SR 1)
 - F Globe valve 1" 1)
- Others:
- G Pump 3)
 - L Water bypass 3)
 - K Coil water/ethylene glycol 3)
- 1 - Delivered separately
2 - Fitted and connected
3 - Not part of delivery

COOLING CAPACITY

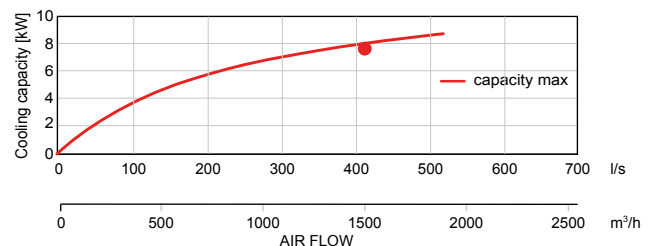

DX COIL

DX coil		Supply
Air volume	m ³ /h / l/s	1500 / 417
Temperature at inlet (after heat recovery)	°C	28
Temperature at outlet (downstream of the DX coil)	°C	18
Inlet relative humidity (after heat recovery)	% RH	51
Outlet relative humidity (downstream of the DX coil)	% RH	77
Cooling capacity	kW	5.83
Condensate production	l/h	5
Refrigerant type		R410A
Evaporating temperature	°C	9

Note: The figures above have been measured at 1500 m³/h and 200 Pa. Please use the Duplexvent Selection Software to calculate measurements at other performance levels.

COOLING CAPACITY

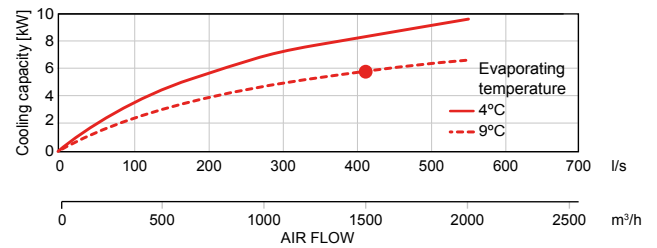

DIMENSIONS

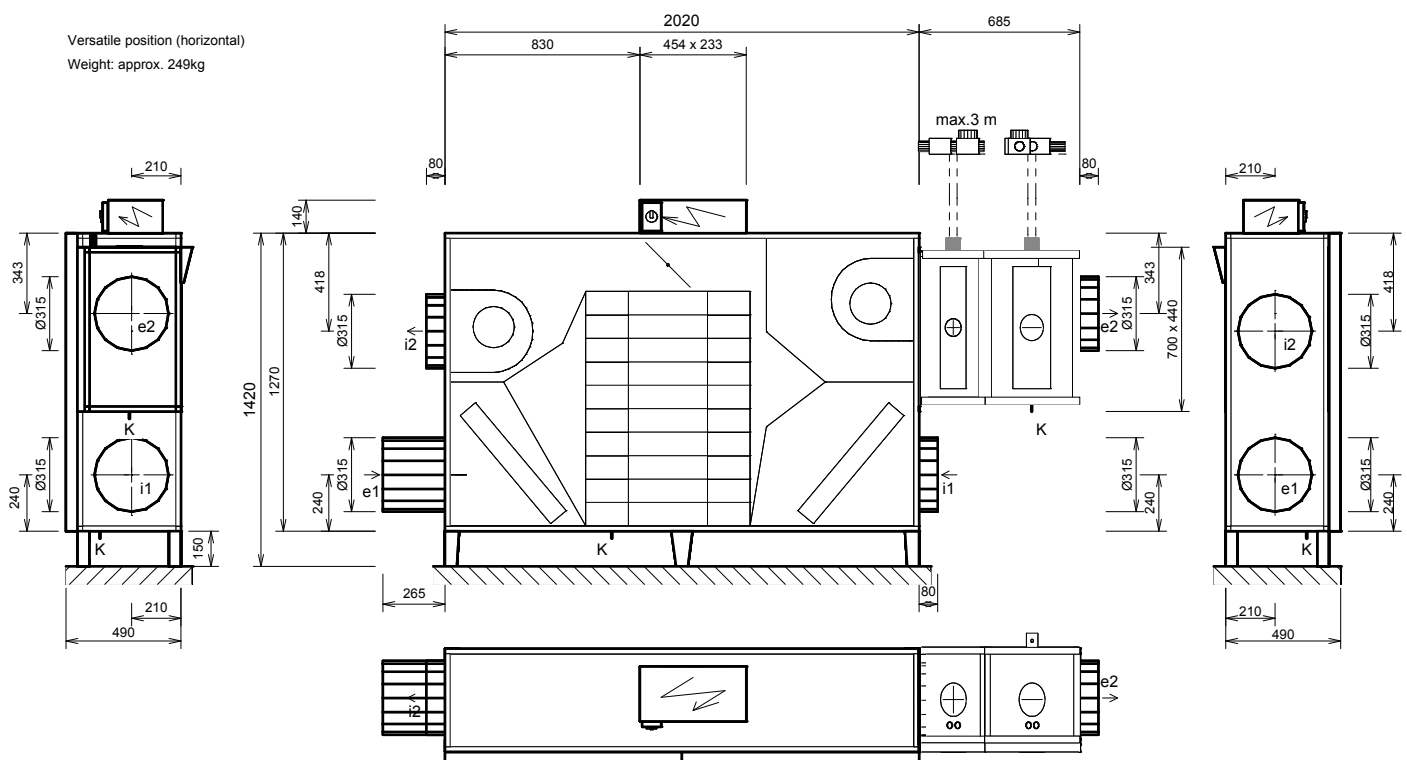

Connections	Type	Dimensions	Optional components
e1	e1- outdoor air (ODA)	Ø 315 mm	Shutoff damper, Flexible connection
e2	e2- supply air (SUP)	Ø 315 mm	Flexible connection
i1	i1- extract air (ETA)	Ø 315 mm	Shutoff damper, Flexible connection
i2	i2- exhaust air (EHA)	Ø 315 mm	Flexible connection
K	condensate drain	2x Ø 16 mm /22 mm	Condensate pump

Notice:

- Unit supplied as one piece
- Door – 2 parts
- Diagram is intended only for basic information, binding dimensions receive at device delivery, or on request from the manufacturer.

Duplexvent Flexi DV2600

Flexi Line Side Entry



KEY FEATURES

- Air volume up to 2500 m³/h at 200 Pa according to ErP 2018
- Excellent thermal efficiency, up to 91%
- Versatile unit positioning with floor and ceiling mounting options
- Low SFP with energy saving EC fans
- Low noise, refer to NR35 and BB93 standards
- Excellent thermal insulation (class T2, TB1)
- 100% adjustable digital controller with Internet and BMS connection
- BREEAM, Passive House and ErP 2018 compliant
- 2 year warranty +

PERFORMANCE

Ventilation		Supply Air	Extract Air
Air volume @ 200 Pa	m ³ /h / l/s	2500 / 694	2500 / 694
Nominal voltage	V	230	230
Nominal power (at operation point)	kW	0.73	0.6
Fan Speed	min ⁻¹	2377	2242
Max power input	kW	0.83	0.83
Max current	A	4	4
Fan Type		EC	EC

Note: The figures above have been measured at 2500 m³/h and 200 Pa. Please use the Duplexvent Selection Software to calculate measurements at other performance levels.

Heat Recovery		Supply Air	Extract Air
Air volume @ 200 Pa	m ³ /h / l/s	2500 / 694	2500 / 694
Temperature at inlet	°C	-5	20
Temperature at outlet	°C	16.5	3.1
Humidity at inlet	% RH	90	40
Humidity at outlet	% RH	19	96
Heat recovery efficiency winter / summer	%	83 / 79	
Performance in winter / summer	kW	18.0 / 4.1	
Condensation	l/h	3.9	
Type of heat exchanger		Cross-counter-flow, Plastic	
Part No.		90000069	

Note: The figures above have been measured at 2500 m³/h and 200 Pa. Please use the Duplexvent Selection Software to calculate measurements at other performance levels.

Sound Power Level L _w	Total	63 Hz	125 Hz	250 Hz	500 Hz	1 kHz	2 kHz	4 kHz	8 kHz
	dB (A)								
Outdoor air e1	56	41	45	52	52	46	40	30	<25
Supply air e2	82	55	61	78	76	74	72	67	62
Extract air i1	62	46	48	61	53	45	39	<25	<25
Exhaust air i2	83	57	61	81	75	72	70	65	59
Breakout noise	62	41	45	59	56	54	54	48	37
Sound Pressure Level L _p measured at 3m	42	<25	25	38	35	34	33	27	<25

Note: The figures above have been measured at 2500 m³/h and 200 Pa. Please use the Duplexvent Selection Software to calculate measurements at other performance levels.

AIR FLOW CURVE

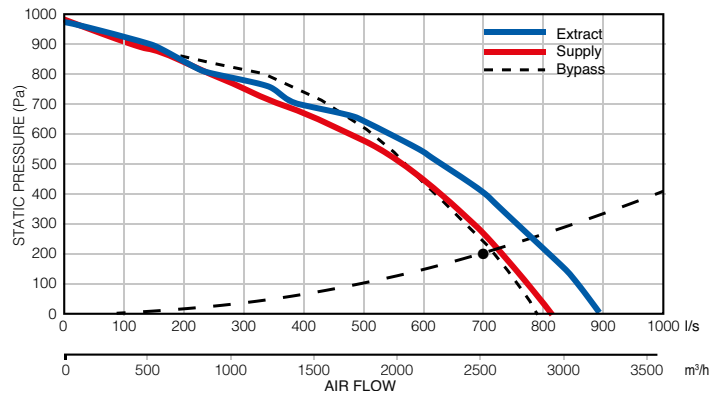

POWER CONSUMPTION

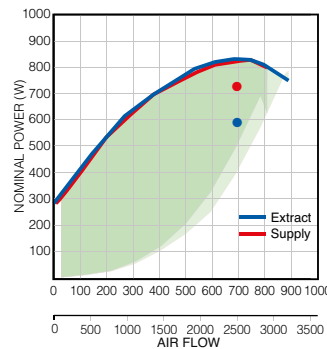

Note: Green area denotes power consumption range. Power consumption depends on system installation.

+excludes motors. Motor warranty one year from date of purchase.

HEAT RECOVERY EFFICIENCY

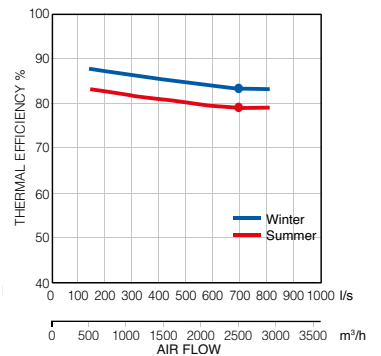



2018

Winter Operation:

e1 - outdoor air (ODA) i1 - extract air (ETA)
e2 - supply air (SUP) i2 - exhaust air (EHA)

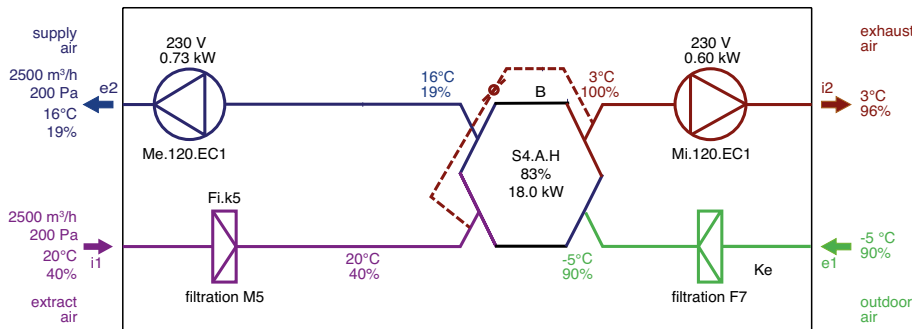

Note: AHU functions diagram. Inlet and outlet location may differ from actual position and port configuration.

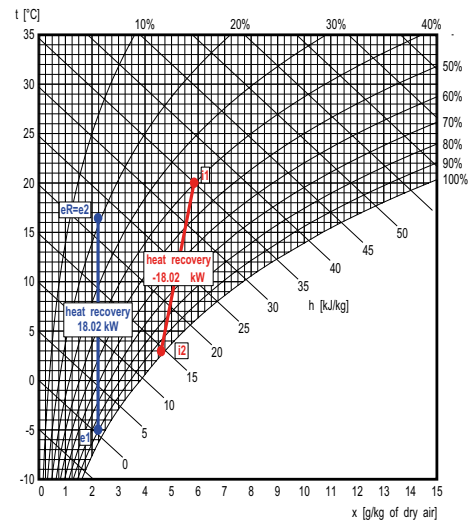

Supply

	Description	t [°C]	RH [%]
e1	Outdoor Air	-5.0	90
e2	Supply Air	16.5	19

Exhaust

	Description	t [°C]	RH [%]
i1	Extract Air	20.0	40
i2	Exhaust Air	3.1	96

Summer Operation:

e1 - outdoor air (ODA) i1 - extract air (ETA)
e2 - supply air (SUP) i2 - exhaust air (EHA)

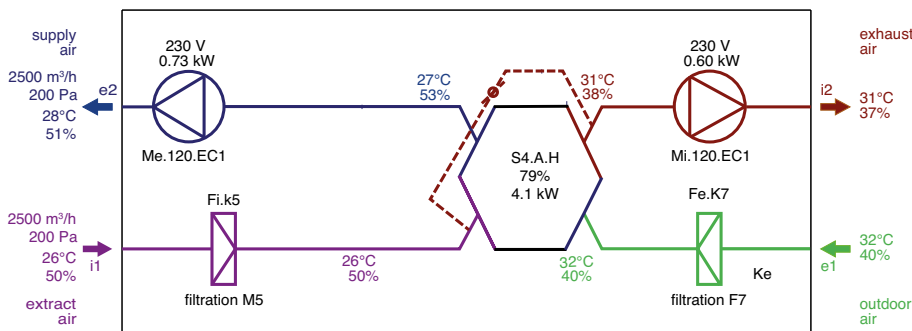

Note: AHU functions diagram. Inlet and outlet location may differ from actual position and port configuration.

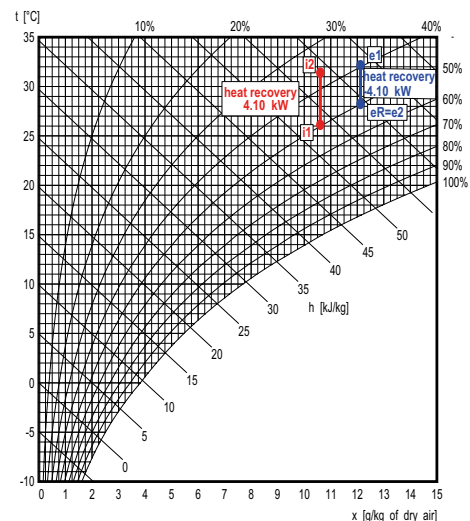

Supply

	Description	t [°C]	RH [%]
e1	Outdoor Air	32.0	40
e2	Supply Air	28.0	51

Exhaust

	Description	t [°C]	RH [%]
i1	Extract Air	26.0	50
i2	Exhaust Air	31.3	37

FILTERS

Filtration	Supply	Extract	Accessories (part of delivery)
Type	Pleated Cartridge		Pfe dirty filter pressure switch for supply air Pfi dirty filter pressure switch for extract air
Filtration class	ePM2,5 65 % (F7)	ePM10 70 % (M5)	
Number of filters	pcs 1	1	
Filter cartridge size	mm 475x700x96	475x700x96	

Duplexvent Flexi DV2600

Flexi Line Side Entry

OPTIONAL ACCESSORIES

ELECTRIC PRE-HEATER

Electric pre-heater		Supply
Air volume	m ³ /h / l/s	2500 / 694
Maximum heating capacity	kW	10.5
Voltage	V	400
Connection ports	mm	500 x 250

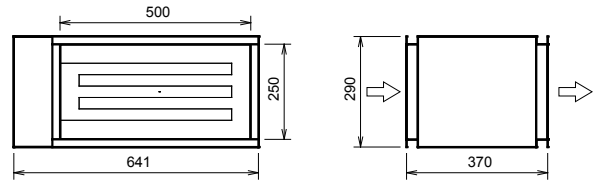

WATER HEATING COIL

Water heating coil		Supply
Heating medium		Water
Air volume	m ³ /h / l/s	2500 / 694
Temperature at inlet (after heat recovery)	°C	17
Temperature at outlet (downstream of the heater)	°C	20
Heating capacity	kW	3
Heating medium temperature drop	°C	70/50
Medium flow (from source)	l/h	129
Connection dimension (hydraulic kit)		1" female

Note: The figures above have been measured at 2500 m³/h and 200 Pa. Please use the Duplexvent Selection Software to calculate measurements at other performance levels.

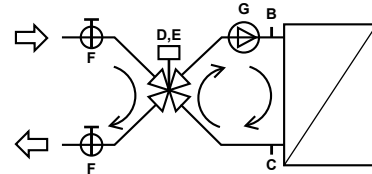

- B Sludge valve plug 2)
 - C Sludge valve plug 2)
 - Hydraulic kit: **RE-HW4.LM24A-SR**
 - D Mixing valve IVAR.MIX4, Kv 12, 1" 1)
 - E Actuator LM24A-SR 1)
 - F Globe valve 1" 1)
 - G Pump WILO YONOS PARA RS 20/6- RKC 1)
- 1 - Delivered separately
2 - Fitted and connected

HEATING CAPACITY

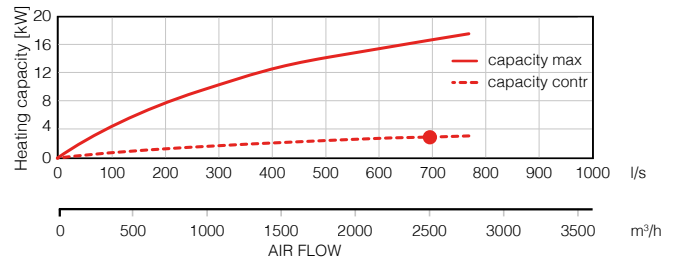

WATER COOLING COIL

Water cooling coil		Supply
Cooling medium		21% Ethylene glycol
Air volume	m ³ /h / l/s	2500 / 694
Temperature at inlet (after heat recovery)	°C	28
Temperature at outlet (downstream of the cooling coil)	°C	18
Inlet relative humidity (after heat recovery)	% RH	50
Outlet relative humidity (downstream of the cooling coil)	% RH	81
Cooling capacity	kW	12.7
Condensate production	l/h	6
Water temperature drop	°C	6 / 12
Medium flow (at max. capacity)	l/h	1970
Medium-side pressure drop		
in heat exchanger	kPa	53.61
in valve	kPa	3.81
Connection dimension		1" female

Note: The figures above have been measured at 2500 m³/h and 200 Pa. Please use the Duplexvent Selection Software to calculate measurements at other performance levels.

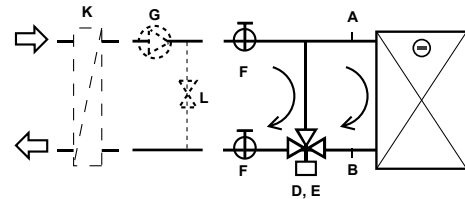

- A,B Sludge valve plug 2)
 - Hydraulic kit: **R-CW3.TR 24-SR**
 - D 3-way ball valve R320BM, Kv 21, ¾" 1)
 - E Actuator TR 24-SR 1)
 - F Globe valve 1" 1)
- Others:
- G Pump 3)
 - L Water bypass 3)
 - K Coil water/ethylene glycol 3)
- 1 - Delivered separately
2 - Fitted and connected
3 - Not part of delivery

COOLING CAPACITY

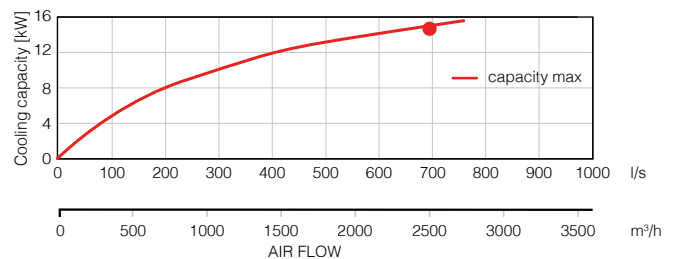

Duplexvent Flexi DV3600

Flexi Line Side Entry



KEY FEATURES

- Air volume up to 3800 m³/h at 200 Pa according to ErP 2018
- Excellent thermal efficiency, up to 93%
- Versatile unit positioning with floor and ceiling mounting options
- Low SFP with energy saving EC fans
- Low noise, refer to NR35 and BB93 standards
- Excellent thermal insulation (class T2, TB1)
- 100% adjustable digital controller with Internet and BMS connection
- BREEAM, Passive House and ErP 2018 compliant
- 2 year warranty +

PERFORMANCE

Ventilation		Supply Air	Extract Air
Air volume @ 200 Pa	m ³ /h / l/s	3500 / 972	3500 / 972
Nominal voltage	V	400	400
Nominal power (at operation point)	kW	0.88	0.80
Fan Speed	min ⁻¹	2100	2071
Max power input	kW	2.5	2.5
Max current	A	3.8	3.8
Fan Type		EC	EC

Note: The figures above have been measured at 3500 m³/h and 200 Pa. Please use the Duplexvent Selection Software to calculate measurements at other performance levels.

Heat Recovery		Supply Air	Extract Air
Air volume @ 200 Pa	m ³ /h / l/s	3500 / 972	3500 / 972
Temperature at inlet	°C	-5	20
Temperature at outlet	°C	17.2	2.6
Humidity at inlet	% RH	90	40
Humidity at outlet	% RH	18	97
Heat recovery efficiency winter / summer	%	87 / 82	
Performance in winter / summer	kW	26.3 / 6.0	
Condensation	l/h	6.1	
Type of heat exchanger		Cross-counter-flow, Plastic	
Part No.		90000070	

Note: The figures above have been measured at 3500 m³/h and 200 Pa. Please use the Duplexvent Selection Software to calculate measurements at other performance levels.

Sound Power Level L _w	Total	dB (A)							
		63 Hz	125 Hz	250 Hz	500 Hz	1 kHz	2 kHz	4 kHz	8 kHz
Outdoor air e1	59	40	48	54	57	46	42	29	<25
Supply air e2	87	54	62	86	78	74	71	67	61
Extract air i1	58	39	48	54	55	45	40	28	<25
Exhaust air i2	85	53	62	84	75	73	69	64	59
Breakout noise	65	37	47	64	57	56	54	48	38
Sound Pressure Level L _p measured at 3m	45	<25	26	43	36	36	33	27	<25

Note: The figures above have been measured at 3500 m³/h and 200 Pa. Please use the Duplexvent Selection Software to calculate measurements at other performance levels.

AIR FLOW CURVE

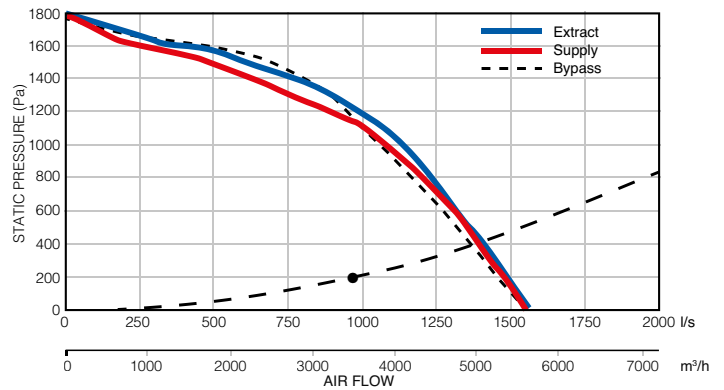

POWER CONSUMPTION

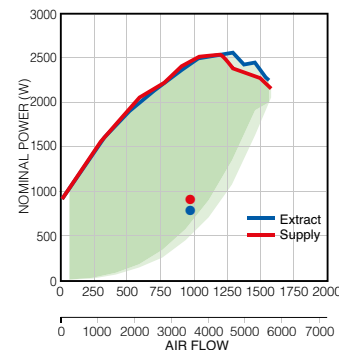

Note: Green area denotes power consumption range. Power consumption depends on system installation.

+excludes motors. Motor warranty one year from date of purchase.

HEAT RECOVERY EFFICIENCY

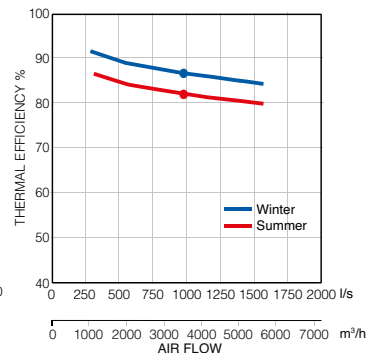

Duplexvent Flexi DV3600

Flexi Line Side Entry

OPTIONAL ACCESSORIES

ELECTRIC PRE-HEATER

Electric pre-heater		Supply
Air volume	m ³ /h / l/s	3500 / 972
Maximum heating capacity	kW	13.5
Voltage	V	400
Connection ports	mm	600 x 300

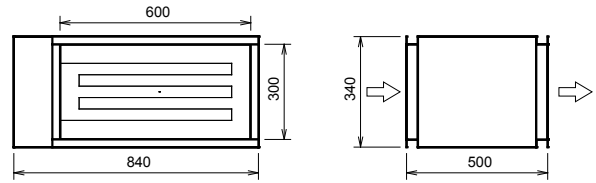

WATER HEATING COIL

Water heating coil		Supply
Heating medium		Water
Air volume	m ³ /h / l/s	3500 / 972
Temperature at inlet (after heat recovery)	°C	17
Temperature at outlet (downstream of the heater)	°C	20
Heating capacity	kW	3.1
Heating medium temperature drop	°C	70/50
Medium flow (from source)	l/h	132
Connection dimension (hydraulic kit)		1" female

Note: The figures above have been measured at 3500 m³/h and 200 Pa. Please use the Duplexvent Selection Software to calculate measurements at other performance levels.

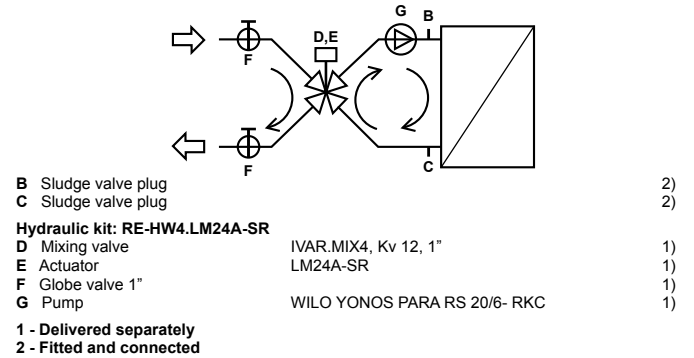

HEATING CAPACITY

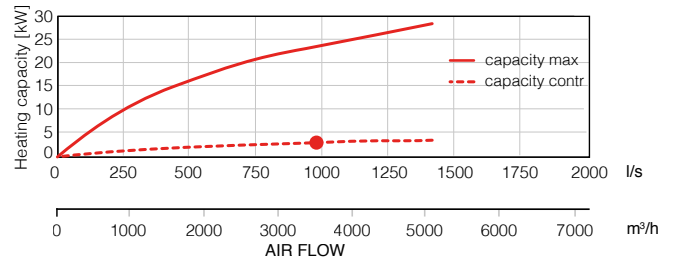

WATER COOLING COIL

Water cooling coil		Supply
Cooling medium		21% Ethylene glycol
Air volume	m ³ /h / l/s	3500 / 972
Temperature at inlet (after heat recovery)	°C	28
Temperature at outlet (downstream of the cooling coil)	°C	17
Inlet relative humidity (after heat recovery)	% RH	51
Outlet relative humidity (downstream of the cooling coil)	% RH	82
Cooling capacity	kW	19.3
Condensate production	l/h	10
Water temperature drop	°C	6 / 12
Medium flow (at max. capacity)	l/h	3100
Medium-side pressure drop		
in heat exchanger	kPa	72.57
in valve	kPa	9.39
Connection dimension		1" female

Note: The figures above have been measured at 3500 m³/h and 200 Pa. Please use the Duplexvent Selection Software to calculate measurements at other performance levels.

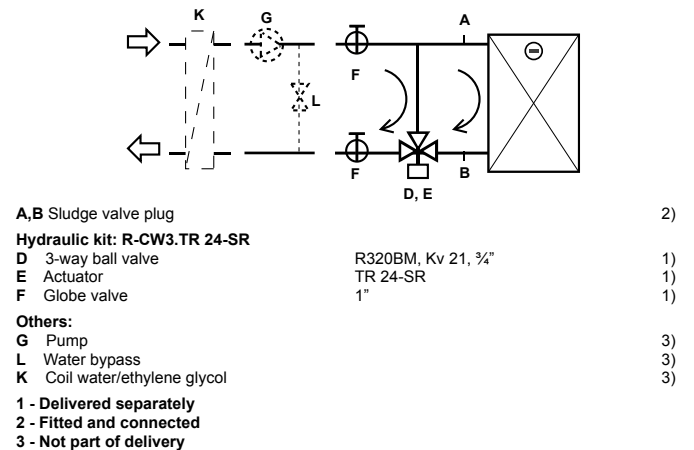

COOLING CAPACITY

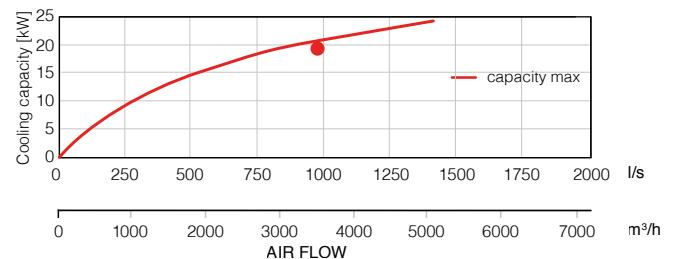

DX COIL

DX coil		Supply
Air volume	m ³ /h / l/s	3500 / 972
Temperature at inlet (after heat recovery)	°C	28
Temperature at outlet (downstream of the DX coil)	°C	17
Inlet relative humidity (after heat recovery)	% RH	51
Outlet relative humidity (downstream of the DX coil)	% RH	77
Cooling capacity	kW	15.63
Condensate production	l/h	12
Refrigerant type		R410A
Evaporating temperature	°C	9

Note: The figures above have been measured at 3500 m³/h and 200 Pa. Please use the Duplexvent Selection Software to calculate measurements at other performance levels.

COOLING CAPACITY

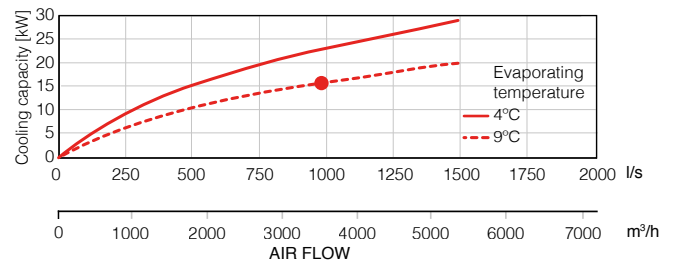

DIMENSIONS

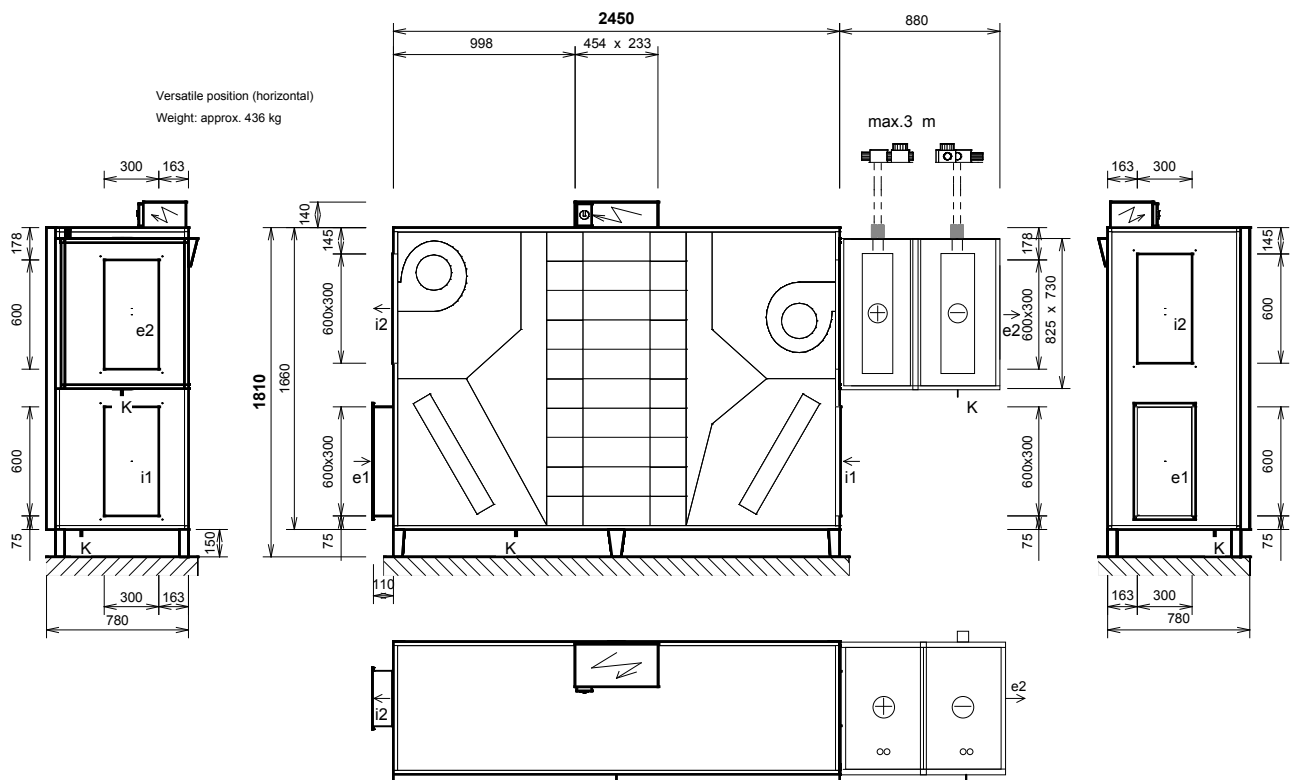

Connections	Type	Dimensions	Optional components
e1	e1- outdoor air (ODA)	600 x 300 mm	Shutoff damper, Flexible connection
e2	e2- supply air (SUP)	600 x 300 mm	Flexible connection
i1	i1- extract air (ETA)	600 x 300 mm	Shutoff damper, Flexible connection
i2	i2- exhaust air (EHA)	600 x 300 mm	Flexible connection
K	condensate drain	2x Ø 16 mm/22 mm	Condensate pump

Notice:

- Unit supplied as one piece
- Door – 2 parts
- Diagram is intended only for basic information, binding dimensions receive at device delivery, or on request from the manufacturer.
- Bolt holes for duct connection (for one port): 4x M6
- Flange width: 20 mm

Duplexvent Multi eco Range - typical features

Heat Recovery Ventilation

KEY COMPONENTS



Now its easier to control Duplexvent units via internet or local network using laptop, smartphone, tablet etc.

Lockable Large Access
Doors simplify and accelerate the maintenance process

Built-in Heaters / Coolers
provide space saving solution

High Grade Filters
G4 (ISO Coarse 60%) /
M5 (ISO ePM10 70%) /
F7 (ISO ePM2.5 65%)
provide ultra hygienic indoor climate and protect heat exchangers from getting dirty

Smooth Internal Casing
with 30mm insulation (class T2) avoids thermal bridging (class TB1 / TB2), absorbs noise and meets sanitary standards

Condensate Drain
for floor standing installations





2018

Digital Control Box
with internet and
BMS connections

Cross-Counter
Flow Heat Exchanger
up to 93% thermal efficiency
reduce heating bills
significantly and guarantee
a quick return
on investment

Low Energy,
Maintenance Free
EC Fan Technology
ensures long term
savings on
operating costs

Pressure Sensors
for filter monitoring

Temperature
Sensors
for fully automatic
operation of the summer
bypass, frost protection
and heater / cooler
facilities

100% Summer
Bypass Facility
provides a flow of cool,
fresh and filtered air into
the property

Circulation Damper
for indoor temperature /
humidity control



Duplexvent Multi eco

Heat Recovery Ventilation



KEY FEATURES

- Heat recovery ventilation
- 100% customisation
- 93% thermal efficiency
- Optimised range with more efficient fans
- Automatic 100% bypass
- Built-in heating / cooling coils
- Integrated web server enables to control the unit via internet
- BMS connection (Modbus as a standard, optional BACnet or KNX)
- VAV control compatibility
- 2 year warranty +

Duplexvent Multi eco

As a ventilation specialist we aim to provide ventilation solutions for commercial applications thanks to our broad range of Commercial Heat Recovery units with nominal air flow from 500 to 8000 m³/h and availability of indoor and outdoor versions.

To offer you the greatest choice in meeting your commercial ventilation needs, have expanded our Multi line range to include

the Multi eco range of energy efficient units, which still match your specification in terms of installation flexibility, performance and quality by meeting the high air volume requirements for commercial and large industrial spaces

+ Excludes motors. Motor warranty one year from date of purchase

Multi eco LINE UNIT CONFIGURATIONS

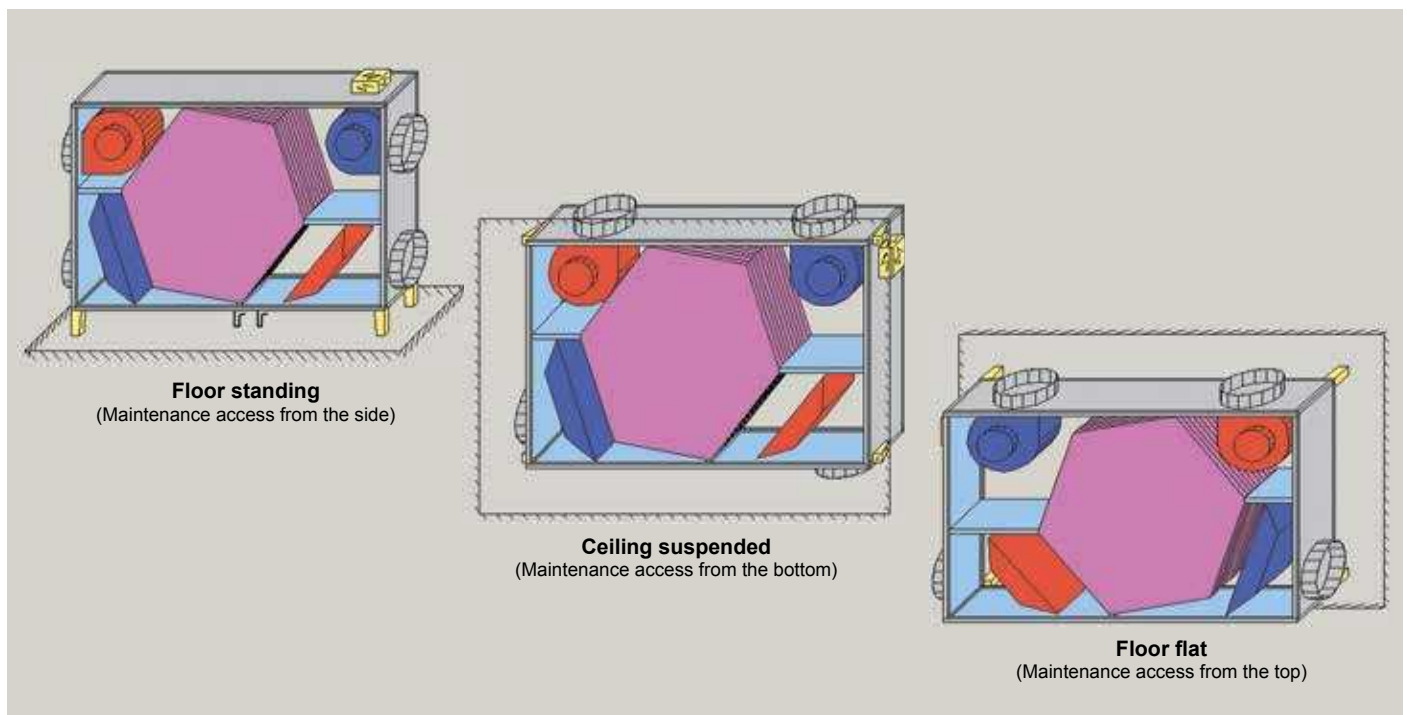



100% CUSTOMISATION AND SHORT DELIVERY TIME

Multi eco range units follow the business philosophy of multiple variability. Designers can easily modify unit positions, spigot connections, filters, integral heating/cooling coils, bypass and circulation dampers using the selection software which accelerates the specification process and helps meet stringent project requirements.

Thanks to the use of selection software Multi eco units are tailored to the individual needs of each customer.

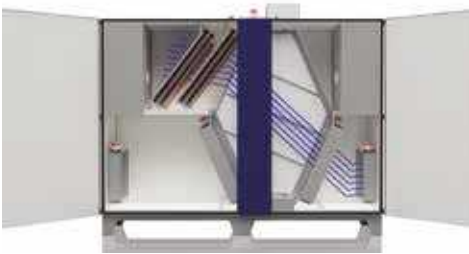

100% Bypass facility delivers cool, fresh and filtered air



Circulation damper helps regulate indoor temperature / humidity conditions



Built-in water / DX coils extra heating / cooling

DUPLEXVENT Multi eco SIZE RANGE

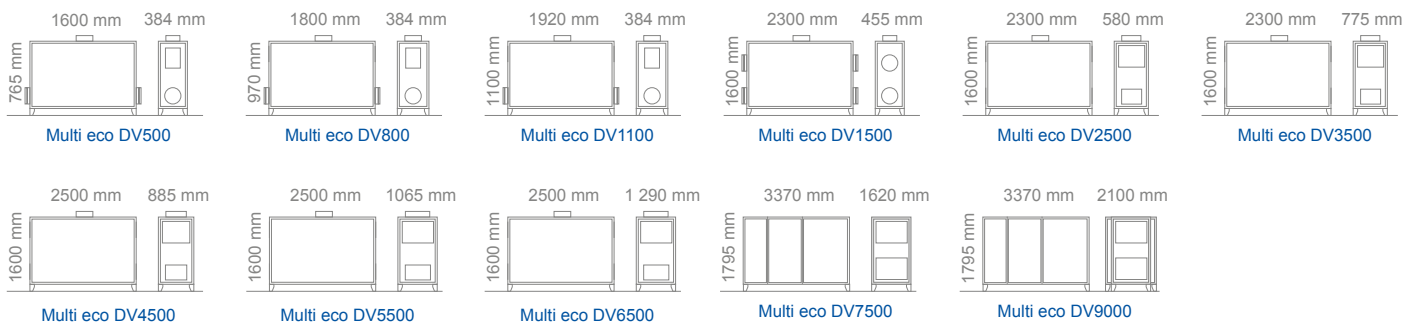

Duplexvent Multi eco

Heat Recovery Ventilation

TECHNICAL DATA

OPERATING MODES

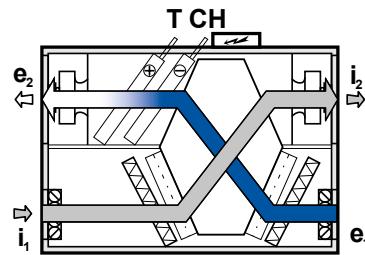

Heat recovery mode
with optional heating and cooling

- ➔ e₁ ...Outdoor air (ODA)
- ➔ e₂ ...Supply air (SUP)

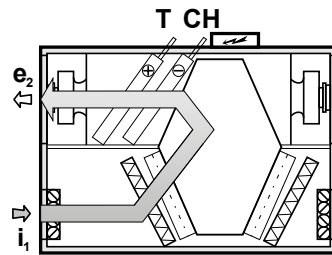

Recirculation mode
with optional heating and cooling

- ➔ i₁ ...Extract air (ETA)
- ➔ i₂ ...Exhaust air (EHA)

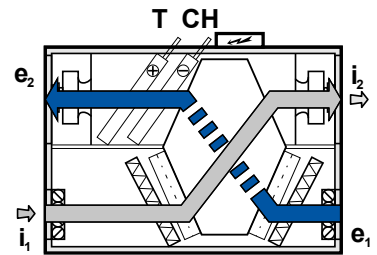

Bypass mode
(without heat recovery)

- T ...Central heating connection
- CH ...Cooling connection

Duplexvent Multi eco		DV500	DV800	DV1100	DV1500	DV2500	DV3500	DV4500	DV5500	DV6500	DV7500	DV9000
Maximum air flow according to ErP 2018	m ³ /h / l/s	550/139	750/208	900/250	1500/417	2300/639	3300/917	4000/1111	4900/1361	5500/1528	7000/1944	8000/2222
Reference external static pressure	Pa	200	200	200	200	200	200	200	200	200	300	400
Heat recovery efficiency	%	see curve										
Fan type		EC (backward curved impeller)										
Weight ¹	kg	80-110	95-130	120-170	200-280	290-370	350-430	370-450	480-560	580-670	1120-1250	1210-1350
Max power input	kW	0.3	0.7	0.8	1.2	2.6	4.5	5.2	6.6	6.6	6.6	8.9
Voltage	V	230					400					
Frequency	Hz	50										
Fan speed	min ⁻¹	4300	3350	3350	2920	3000	2980	2980	2700	2700	2700	2570
Heating output T - max. ²	kW	5	14	16	22	30	42	51	71	80	85	90
Cooling output CHW - max. ²	kW	4	8	10	16	22	30	42	56	62	67	72
Cooling output CHF - max. ²	kW	3	6	8	10	13	25	37	41	50	55	60
Part No.		90000790	90000791	90000792	90000793	90000794	90000795	90000796	90000797	90000798	90000799	90000800

1. Depending on equipment

2. Depending on flow rate, external air temperature, medium type

T - Water heating coil

CHW - Water cooling coil

CHF - DX (direct expansion) coil

PERFORMANCE

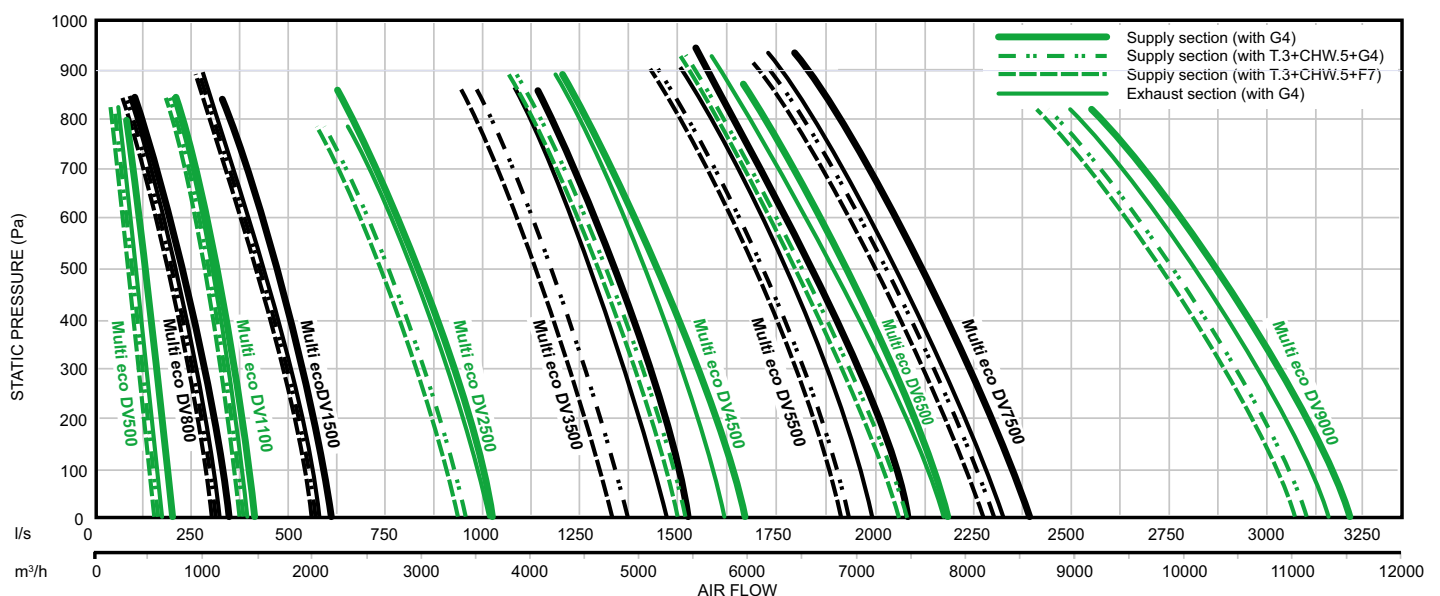

Note: For detailed information we recommend using Duplexvent Selection software available at airflow.com

HEATING AND COOLING CAPACITY

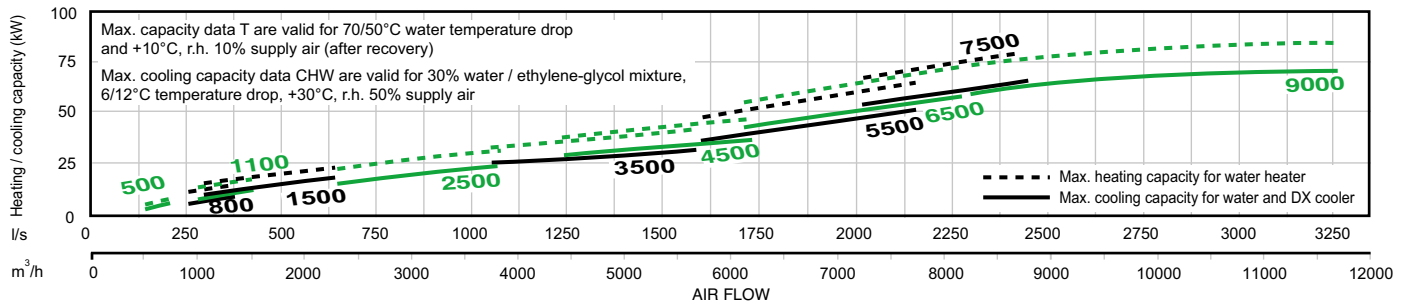

HEAT RECOVERY EFFICIENCY

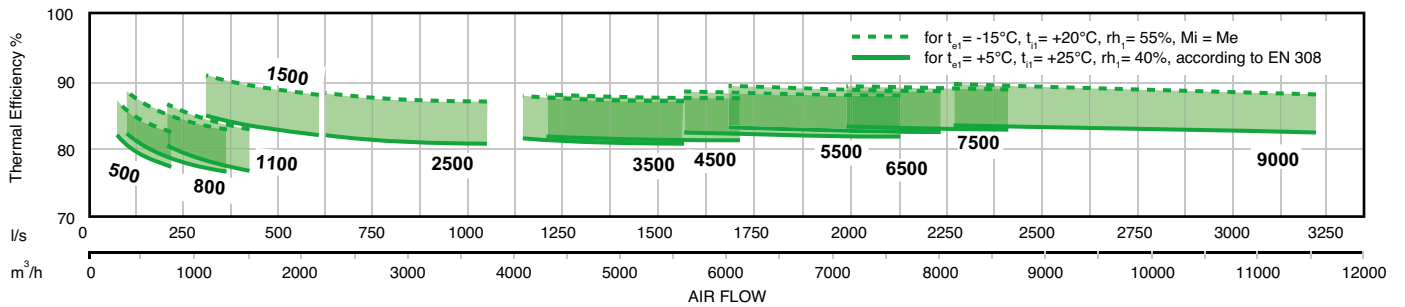

CONNECTION PORTS

Basic port
(inlet, outlet)

Port with flexible range
(inlet, outlet)

Port with damper
(inlet, outlet)

Port with a damper and flexible connection
(inlet, only)

CIRCULAR CONNECTION PORTS

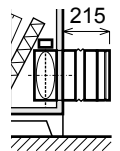
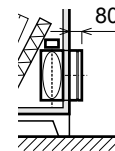
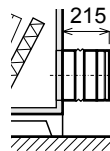
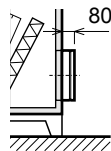
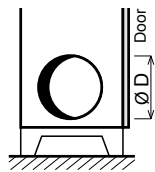

RECTANGULAR CONNECTION PORTS

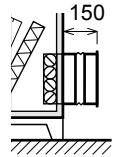
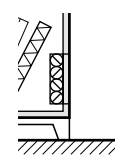
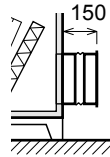
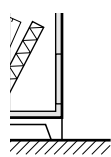
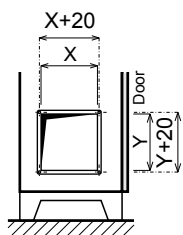

Note: For detailed information we recommend using Duplexvent Selection software available at airflow.com

Duplexvent Multi eco

Heat Recovery Ventilation

INSTALLATION CONFIGURATION

DUPLEXVENT Multi eco INSTALLATION POSITIONS AND PORT CONFIGURATIONS

The Duplexvent Multi eco range is available in a number of different mounting positions. This mounting versatility enables the Duplexvent Multi eco units to be installed in cramped spaces.

Detailed unit drawings that show the different mounting positions are shown, as it is not possible to have all units' sizes available in all mounting positions.

All Duplexvent Multi eco units are available with a wide range of accessories. For example, the ports can be fitted with flexible flanges and shut-off dampers if required.

For a detailed unit design we recommend a Duplexvent selection software to be used; available at www.airflow.com

FLOOR-STANDING HORIZONTAL POSITION Multi eco DV500 to DV9000

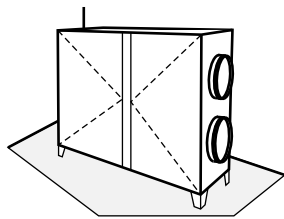

Configuration 10 / 0 to 11 / 10 - door view (up to 8 configurations in total)

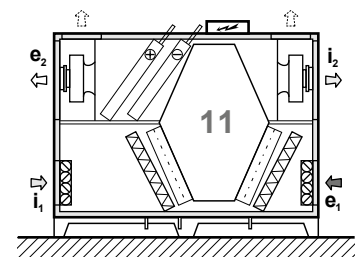
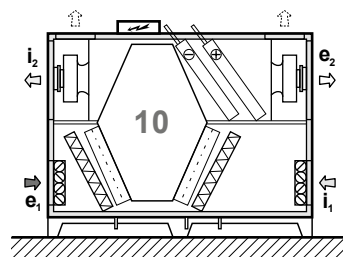

CEILING-SUSPENDED POSITION Multi eco DV500 to DV6500

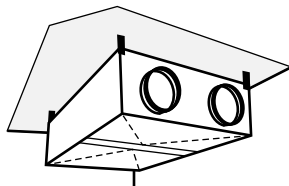

Configuration 30 / 0 to 31 / 15 - door view (up to 32 configurations in total)

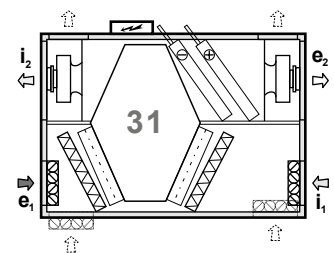
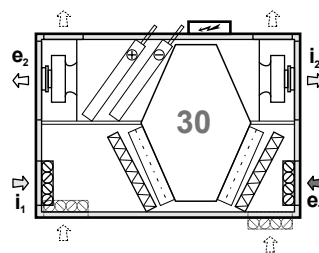

FLOOR-STANDING FLAT POSITION Multi eco DV1500 to DV5500

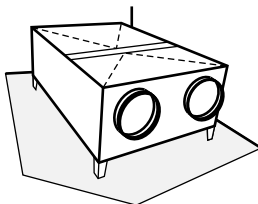

Configuration 40 / 0 to 41 / 15 - door view (up to 32 configurations in total)

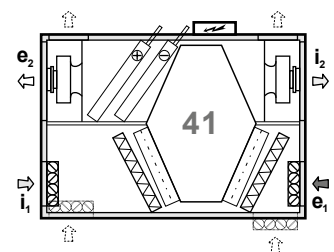
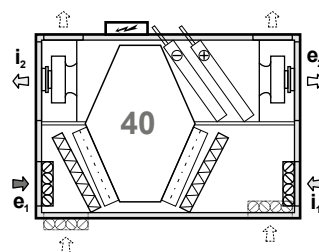

Multi eco DV800 to DV1100 units are available in the following configurations:

- horizontal: 10 / 0, 11 / 0
- ceiling-suspended: 30 / 0, 30 / 1, 30 / 4, 30 / 5, 31 / 1, 31 / 4, 31 / 5

Note: For detailed information we recommend using Duplexvent selection software available at airflow.com

MANIPULATION SPACE

DUPLEXVENT Multi eco MANIPULATION SPACE

Duplexvent Multi eco units must be installed with the unit's handling space (outlined below) in mind.

There must be a 150 mm gap underneath the unit to install the condensate drain system, as the system must run through a U-bend at least 150 mm high into the sewer. This space is easily achieved when the supporting feet, which are supplied as standard, are used when the unit is installed. The handling

space in front of the unit must be maintained so the unit can be serviced.

In addition the handling spaces outlined below, there must be a minimum 600mm space from the side of electric switchboard of the control system.

Units fitted with additional heaters or coolers must have free space from the side of the manifold.

MANIPULATION SPACE, UNIT CONFIGURATION

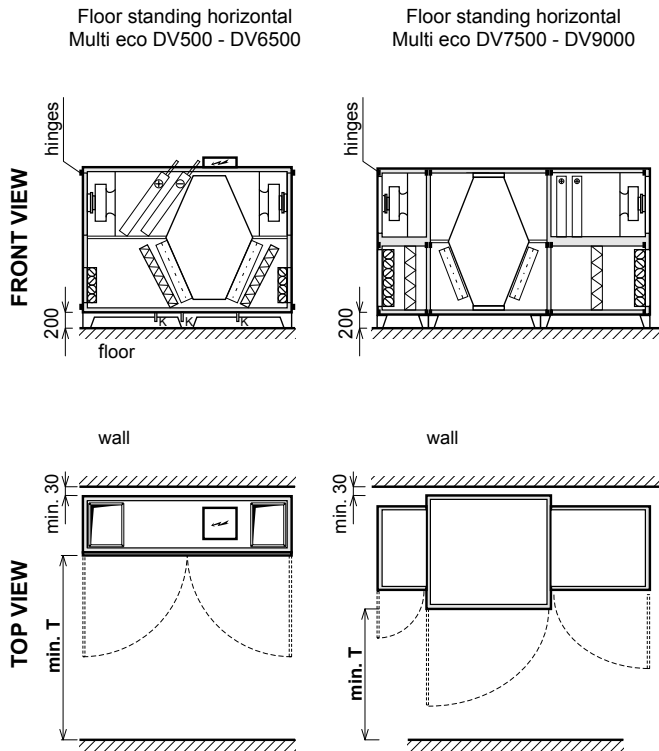

MANIPULATION SPACE FOR UNIT ACCESSORIES

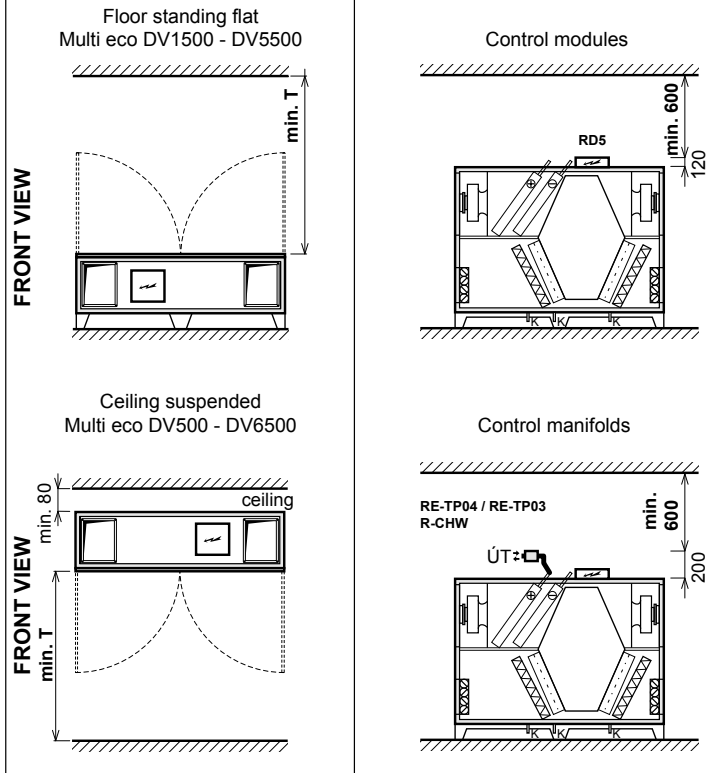

Duplexvent Multi eco	Standard door T [mm]	Hingeless door T [mm]
DV500	800	500
DV800	900	500
DV1100	1000	500
DV1500	1200	500
DV2500	1200	600
DV3500	1200	680
DV4500	1300	900
DV5500	1300	1100
DV6500	1500	1300
DV7500	-	1600
DV9000	-	1600

Duplexvent Multi eco DV500

Commercial MVHR with cross-counter flow heat exchanger - Indoor



PERFORMANCE

Ventilation		Supply Air	Extract Air
Air volume @ 200 Pa	m ³ /h / l/s	500 / 139	500 / 139
Nominal voltage	V	230	230
Nominal power (at operation point)	kW	0.16	0.12
Fan Speed	min ⁻¹	3879	3631
Max power input	kW	0.17	0.17
Max current	A	1.4	1.4
Fan Type		EC	EC

Note: The figures above have been measured at 500 m³/h and 200 Pa. Please use the Duplexvent Selection Software to calculate measurements at other performance levels.

Heat Recovery		Supply Air	Extract Air
Air volume @ 200 Pa	m ³ /h / l/s	500 / 139	500 / 139
Temperature at inlet	°C	-5	20
Temperature at outlet	°C	16.4	3.2
Humidity at inlet	% RH	90	40
Humidity at outlet	% RH	19	96
Heat recovery efficiency winter / summer	%	83 / 79	
Performance in winter / summer	kW	3.6 / 0.8	
Condensation	l/h	0.8	
Type of heat exchanger		Cross-counter-flow, Plastic	
Part No.		90000790	

Note: The figures above have been measured at 500 m³/h and 200 Pa. Please use the Duplexvent Selection Software to calculate measurements at other performance levels.

Sound Power Level L _w	Total	63 Hz	125 Hz	250 Hz	500 Hz	1 kHz	2 kHz	4 kHz	8 kHz
	dB (A)								
Outdoor air e1	51	43	38	44	48	41	41	31	<25
Supply air e2	76	49	58	63	71	71	70	66	62
Extract air i1	60	41	35	45	60	40	40	28	<25
Exhaust air i2	75	47	55	61	71	68	68	63	20
Breakout noise	58	35	37	44	57	47	45	36	27
Sound Pressure Level L _p measured at 3m	37	<25	<25	<25	36	26	<25	<25	<25

Note: The figures above have been measured at 500 m³/h and 200 Pa. Please use the Duplexvent Selection Software to calculate measurements at other performance levels.

KEY FEATURES

- Air volume up to 500 m³/h at 200 Pa according to ErP 2018
- Digital Touchscreen or simple manual controller
- Low noise, refer to NR35 and BB93 standards
- Excellent thermal insulation (class T2, TB1)
- Filters: ePM2,5 65 % (F7), ePM10 70 % (M5) or Coarse 60 % (G4)
- Optional circulation damper
- Optional constant flow and constant pressure mode
- BREEAM and ErP 2018 compliant
- Meets Building Regulations Part L2A and L2B

AIR FLOW CURVE

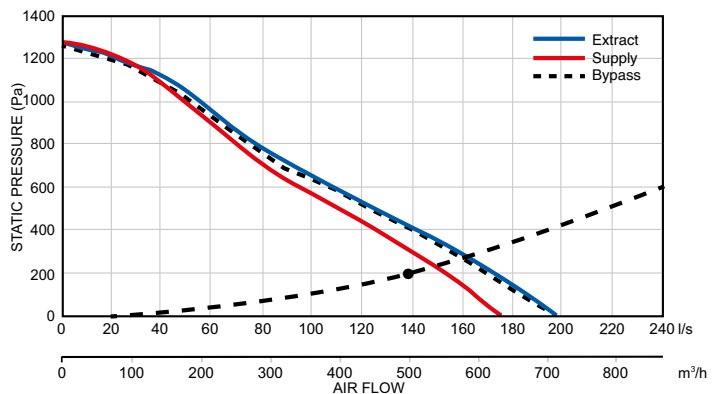

POWER CONSUMPTION

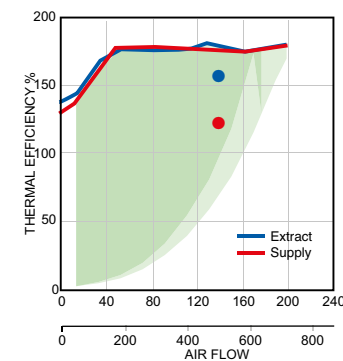

Note: Green area denotes power consumption range. Power consumption depends on system installation.

HEAT RECOVERY EFFICIENCY

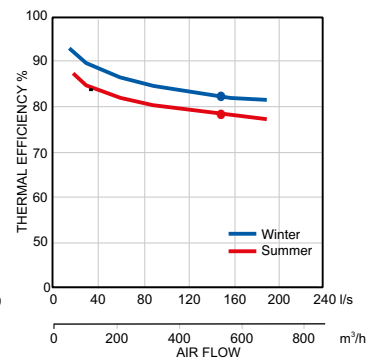

Winter Operation:

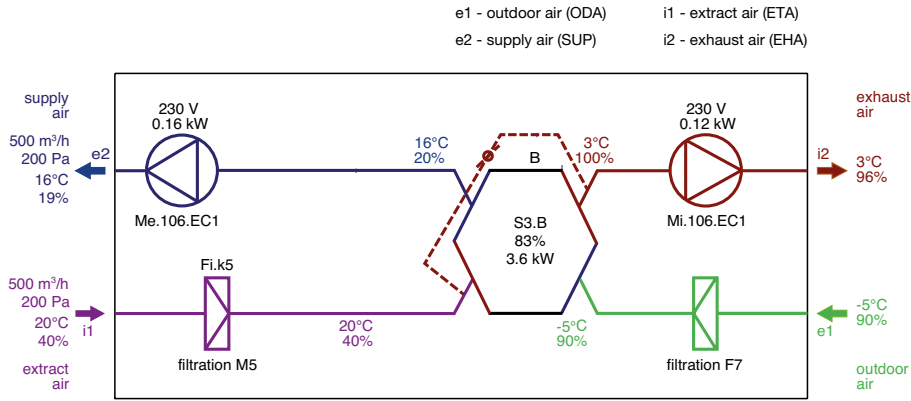

Note: AHU functions diagram. Inlet and outlet location may differ from actual position and port configuration.

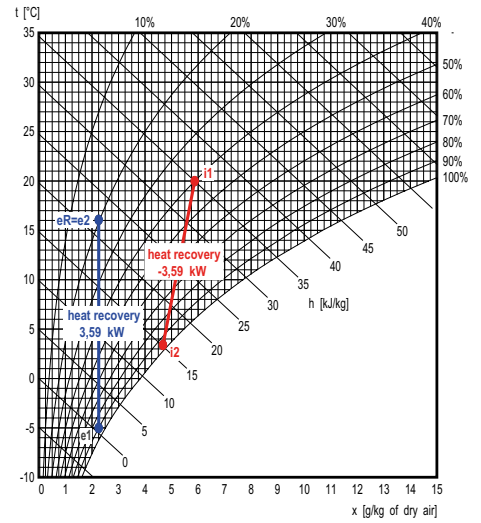

Supply

	Description	t [°C]	RH [%]
e1	Outdoor Air	-5.0	90
e2	Supply Air	16.4	19

Exhaust

	Description	t [°C]	RH [%]
i1	Extract Air	20.0	40
i2	Exhaust Air	3.2	96

Summer Operation:

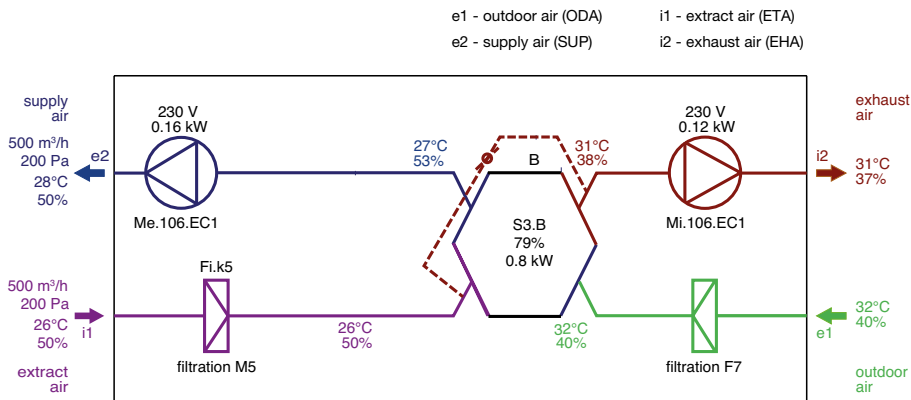

Note: AHU functions diagram. Inlet and outlet location may differ from actual position and port configuration.

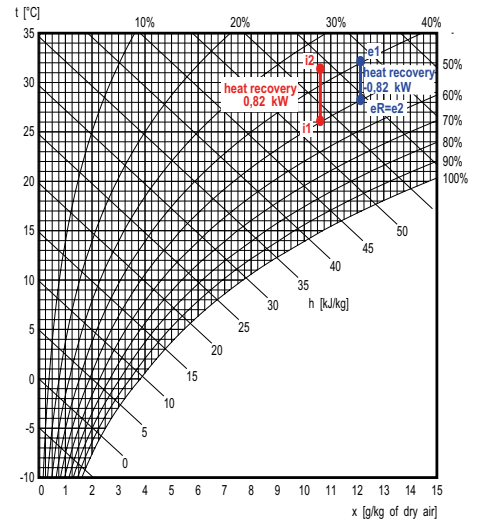

Supply

	Description	t [°C]	RH [%]
e1	Outdoor Air	32.0	40
e2	Supply Air	28.1	50

Exhaust

	Description	t [°C]	RH [%]
i1	Extract Air	26.0	50
i2	Exhaust Air	31.2	37

FILTERS

Filtration	Supply	Extract	Accessories (part of delivery)
Type	Pleated Cartridge		Pfe dirty filter pressure switch for supply air Pfi dirty filter pressure switch for extract air
Filtration class	ePM2,5 65 % (F7)	ePM10 70 % (M5)	
Number of filters	pcs 1	1	
Filter cartridge size	mm 285x300x48	285x300x48	

Duplexvent Multi eco DV500

Commercial MVHR with cross-counter-flow heat exchanger - Indoor

OPTIONAL ACCESSORIES

ELECTRIC PRE-HEATER

Electric pre-heater		Supply
Air volume	m ³ /h / l/s	500 / 139
Maximum heating capacity	kW	2.0
Voltage	V	230
Connection ports	mm	Ø 200

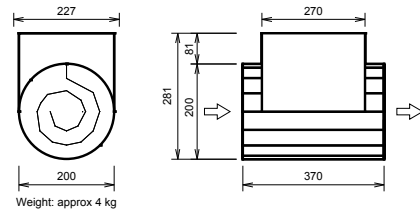

WATER HEATING COIL

Water heating coil		Supply
Heating medium		Water
Air volume	m ³ /h / l/s	500 / 139
Temperature at inlet (after heat recovery)	°C	16
Temperature at outlet (downstream of the heater)	°C	19
Heating capacity	kW	0.6
Heating medium temperature drop	°C	70/50
Medium flow (from source)	l/h	26
Connection dimension (hydraulic kit)		1" female

Note: The figures above have been measured at 500 m³/h and 200 Pa. Please use the Duplexvent Selection Software to calculate measurements at other performance levels.

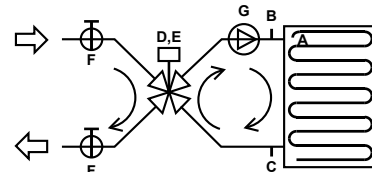

- A Freeze protection thermostat 016-H6927-107-3m 2)
 - B Sludge valve plug 2)
 - C Sludge valve plug 2)
 - Hydraulic kit: RE-HW4.LM24A-SR
 - D Mixing valve IVAR.MIX4, Kv 12, 1" 1)
 - E Actuator LM24A-SR 1)
 - F Globe valve 1" 1)
 - G Pump WILO YONOS PARA RS 20/6- RKC 1)
- 1 - Delivered separately
2 - Fitted and connected

HEATING CAPACITY

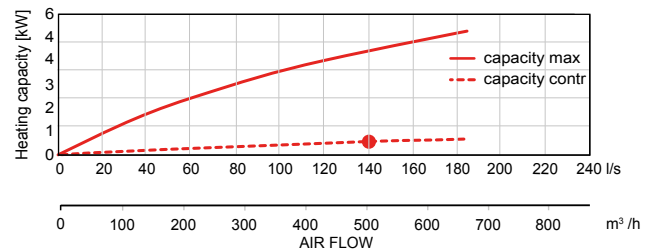

WATER COOLING COIL

Water cooling coil		Supply
Cooling medium		21% Ethylene glycol
Air volume	m ³ /h / l/s	500 / 139
Temperature at inlet (after heat recovery)	°C	27
Temperature at outlet (downstream of the cooling coil)	°C	18
Inlet relative humidity (after heat recovery)	% RH	53
Outlet relative humidity (downstream of the cooling coil)	% RH	85
Cooling capacity	kW	1.9
Condensate production	l/h	1
Water temperature drop	°C	6 / 12
Medium flow (at max. capacity)	l/h	280
Medium-side pressure drop		
in heat exchanger	kPa	9.97
in valve	kPa	0.09
Connection dimension		1" female

Note: The figures above have been measured at 500 m³/h and 200 Pa. Please use the Duplexvent Selection Software to calculate measurements at other performance levels.

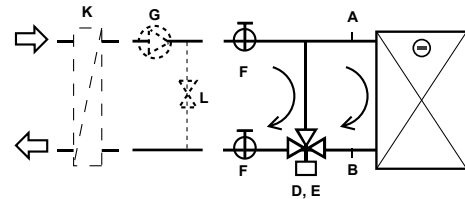

- A, B Sludge valve plug 2)
 - Hydraulic kit: R-CW3.TR 24-SR
 - D 3-way ball valve R3020-B1 1)
 - E Actuator TR 24-SR 1)
 - F Globe valve 1" 1)
 - Others:
 - G Pump 3)
 - L Water bypass 3)
 - K Coil water/ethylene glycol 3)
- 1 - Delivered separately
2 - Fitted and connected
3 - Not part of delivery

COOLING CAPACITY

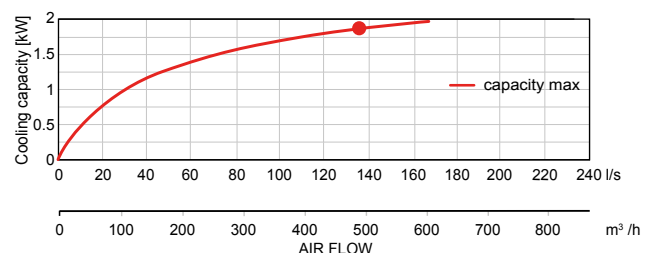

DX COIL

DX coil	Supply	
Air volume	m ³ /h / l/s	500 / 139
Temperature at inlet (after heat recovery)	°C	27
Temperature at outlet (downstream of the DX coil)	°C	18
Inlet relative humidity (after heat recovery)	% RH	53
Outlet relative humidity (downstream of the DX coil)	% RH	73
Cooling capacity	kW	2.0
Condensate production	l/h	2
Refrigerant type		R410A
Evaporating temperature	°C	8

Note: The figures above have been measured at 500 m³/h and 200 Pa. Please use the Duplexvent Selection Software to calculate measurements at other performance levels.

COOLING CAPACITY

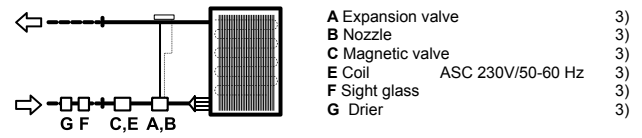
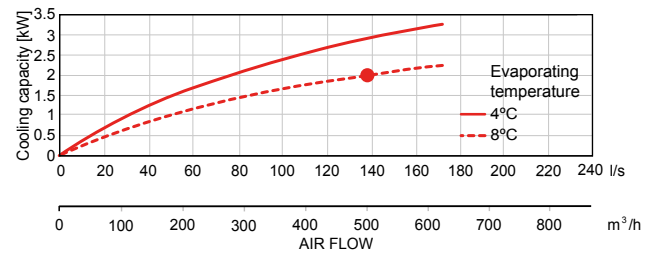

3 Not part of delivery, recommended type mentioned

DIMENSIONS

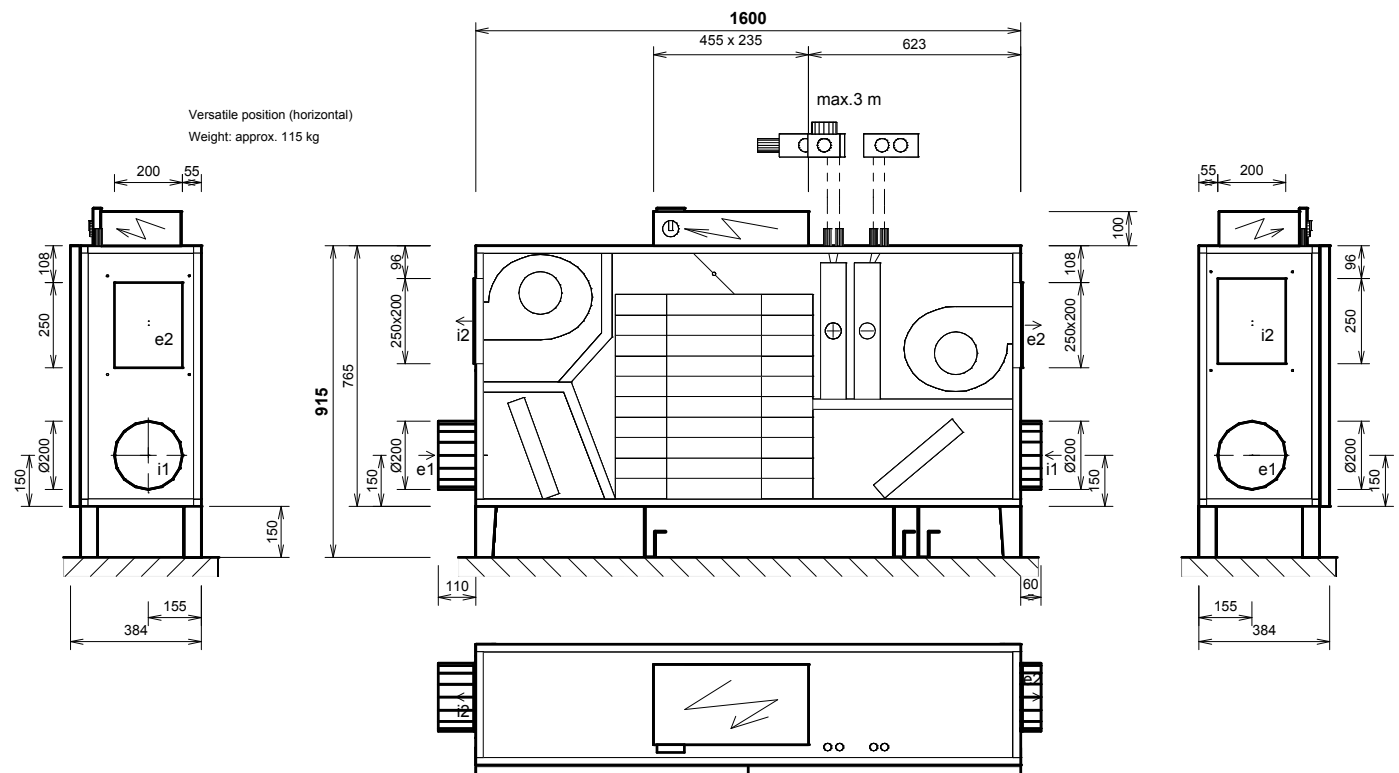

Connections	Type	Dimensions	Optional components
e1	e1- outdoor air (ODA)	Ø 200mm	Shutoff damper, Flexible connection
e2	e2- supply air (SUP)	250 x 200 mm	Flexible connection
i1	i1- extract air (ETA)	Ø 200mm	Shutoff damper, Flexible connection
i2	i2- exhaust air (EHA)	250 x 200 mm	Flexible connection
K	condensate drain	3x Ø 16 mm/22 mm	Condensate pump

Notice:

- Unit supplied as one piece
- Door - 2 parts
- Diagram is intended only for basic information, binding dimensions receive at device delivery, or on request from the manufacturer.
- Bolt holes for duct connection (for one port): 4xM6

Duplexvent Multi eco DV800

Commercial MVHR with cross-counter-flow heat exchanger - Indoor



KEY FEATURES

- Air volume up to 750 m³/h at 200 Pa according to ErP 2018
- Digital Touchscreen or simple manual controller
- Low noise, refer to NR35 and BB93 standards
- Excellent thermal insulation (class T2, TB1)
- Filters: ePM2,5 65 % (F7), ePM10 70 % (M5) or Coarse 60 % (G4)
- Optional circulation damper
- Optional constant flow and constant pressure mode
- BREEAM and ErP 2018 compliant
- Meets Building Regulations Part L2A and L2B

PERFORMANCE

Ventilation		Supply Air	Extract Air
Air volume @ 200 Pa	m ³ /h / l/s	750 / 208	750 / 208
Nominal voltage	V	230	230
Nominal power (at operation point)	kW	0.24	0.20
Fan Speed	min ⁻¹	2800	2669
Max power input	kW	0.39	0.39
Max current	A	2.5	2.5
Fan Type		EC	EC

Note: The figures above have been measured at 750 m³/h and 200 Pa. Please use the Duplexvent Selection Software to calculate measurements at other performance levels.

AIR FLOW CURVE

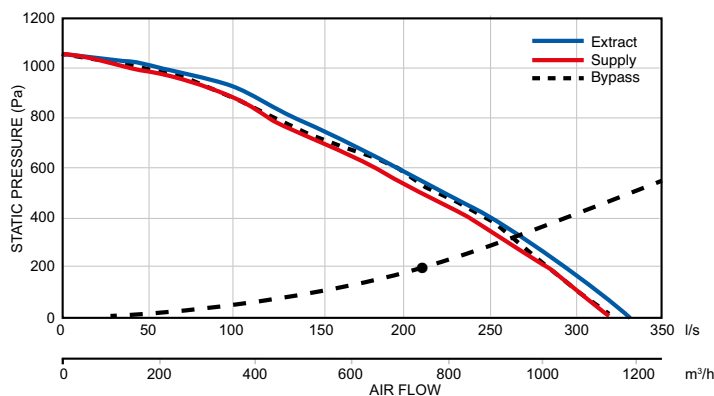

Heat Recovery		Supply Air	Extract Air
Air volume @ 200 Pa	m ³ /h / l/s	750 / 208	750 / 208
Temperature at inlet	°C	-5	20
Temperature at outlet	°C	16.4	3.3
Humidity at inlet	% RH	90	40
Humidity at outlet	% RH	19	96
Heat recovery efficiency winter / summer	%	83 / 78	
Performance in winter / summer	kW	5.4 / 1.2	
Condensation	l/h	1.1	
Type of heat exchanger		Cross-counter-flow, Plastic	
Part No.		90000791	

Note: The figures above have been measured at 750 m³/h and 200 Pa. Please use the Duplexvent Selection Software to calculate measurements at other performance levels.

POWER CONSUMPTION

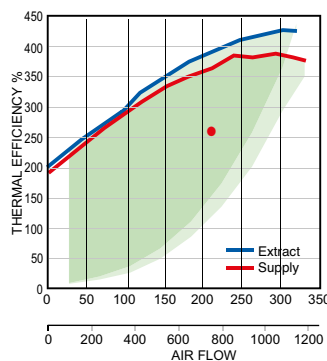

Note: Green area denotes power consumption range. Power consumption depends on system installation.

HEAT RECOVERY EFFICIENCY

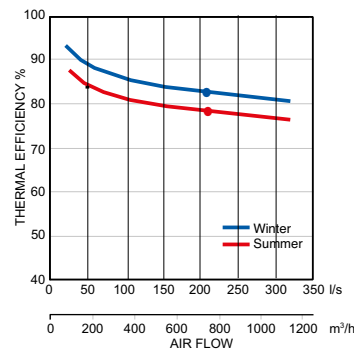

Sound Power Level L _w	Total	63 Hz	125 Hz	250 Hz	500 Hz	1 kHz	2 kHz	4 kHz	8 kHz
	dB (A)								
Outdoor air e1	63	43	48	63	53	47	43	36	<25
Supply air e2	80	53	61	70	74	76	73	66	60
Extract air i1	62	41	47	61	51	46	42	36	<25
Exhaust air i2	78	51	60	68	72	73	70	63	57
Breakout noise	57	38	39	52	53	47	41	25	<25
Sound Pressure Level L _p measured at 3m	36	<25	<25	31	33	27	<25	<25	<25

Note: The figures above have been measured at 750 m³/h and 200 Pa. Please use the Duplexvent Selection Software to calculate measurements at other performance levels.

Winter Operation:

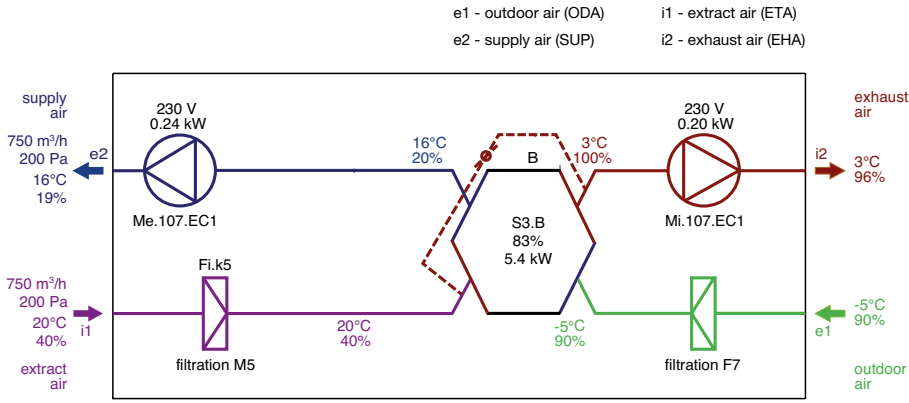

Note: AHU functions diagram. Inlet and outlet location may differ from actual position and port configuration.

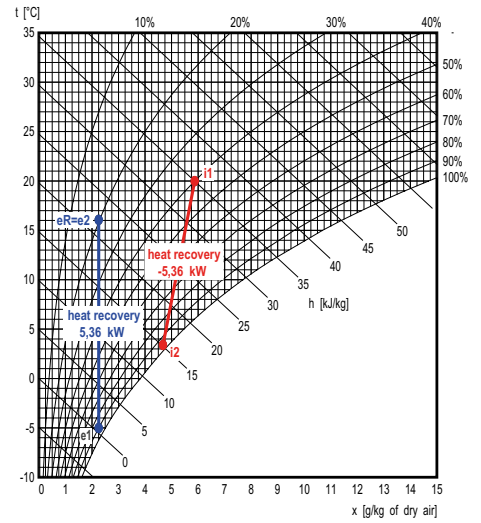

Supply

Description	t [°C]	RH [%]
e1 Outdoor Air	-5.0	90
e2 Supply Air	16.4	19

Exhaust

Description	t [°C]	RH [%]
i1 Extract Air	20.0	40
i2 Exhaust Air	3.3	96

Summer Operation:

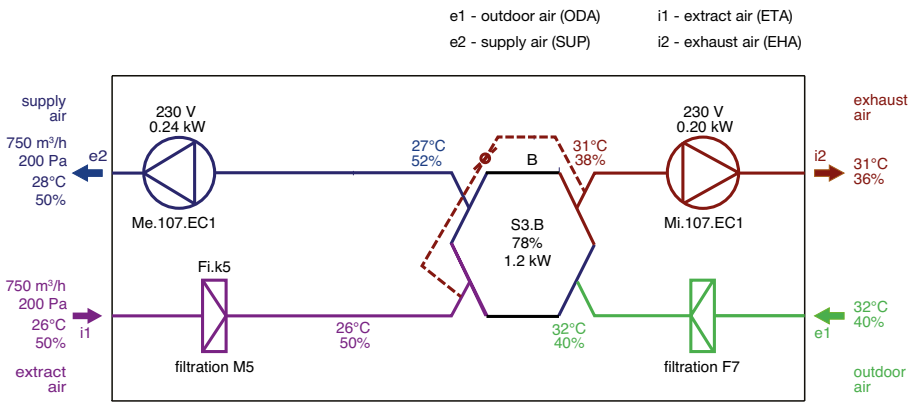

Note: AHU functions diagram. Inlet and outlet location may differ from actual position and port configuration.

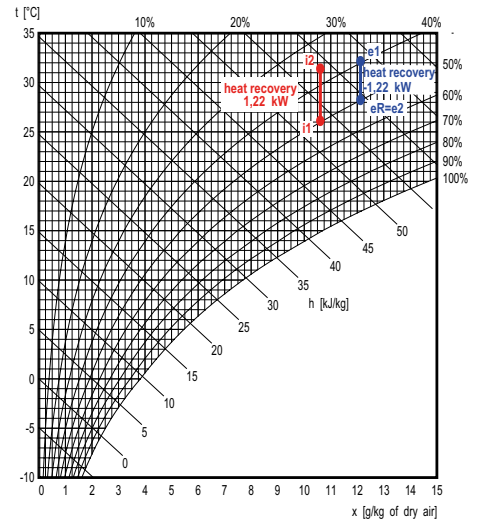

Supply

Description	t [°C]	RH [%]
e1 Outdoor Air	32.0	40
e2 Supply Air	28.1	50

Exhaust

Description	t [°C]	RH [%]
i1 Extract Air	26.0	50
i2 Exhaust Air	31.3	36

FILTERS

Filtration	Supply	Extract	Accessories (part of delivery)
Type	Pleated Cartridge		Pfe dirty filter pressure switch for supply air Pfi dirty filter pressure switch for extract air
Filtration class	F7	M5	
Number of filters	pcs 1	1	
Filter cartridge size	mm 340x300x48	340x300x48	

Duplexvent Multi eco DV800

Commercial MVHR with cross-counter-flow heat exchanger - Indoor

OPTIONAL ACCESSORIES

ELECTRIC PRE-HEATER

Electric pre-heater		Supply
Air volume	m ³ /h / l/s	750 / 208
Maximum heating capacity	kW	2.0
Voltage	V	230
Connection ports	mm	Ø 250

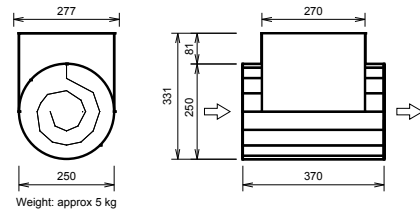

WATER HEATING COIL

Water heating coil		Supply
Heating medium		Water
Air volume	m ³ /h / l/s	750 / 208
Temperature at inlet (after heat recovery)	°C	16
Temperature at outlet (downstream of the heater)	°C	19
Heating capacity	kW	0.9
Heating medium temperature drop	°C	70/50
Medium flow (from source)	l/h	39
Connection dimension (hydraulic kit)		1" female

Note: The figures above have been measured at 750 m³/h and 200 Pa. Please use the Duplexvent Selection Software to calculate measurements at other performance levels.

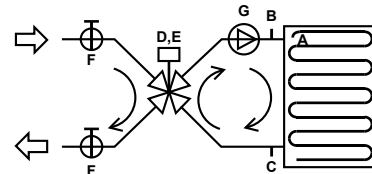

- A Freeze protection thermostat 016-H6927-107-3m 2)
- B Sludge valve plug 2)
- C Sludge valve plug 2)
- Hydraulic kit: RE-HW4.LM24A-SR**
- D Mixing valve IVAR.MIX4, Kv 12, 1" 1)
- E Actuator LM24A-SR 1)
- F Globe valve 1" 1)
- G Pump WILO YONOS PARA RS 20/6- RKC 1)

1 - Delivered separately
2 - Fitted and connected

HEATING CAPACITY

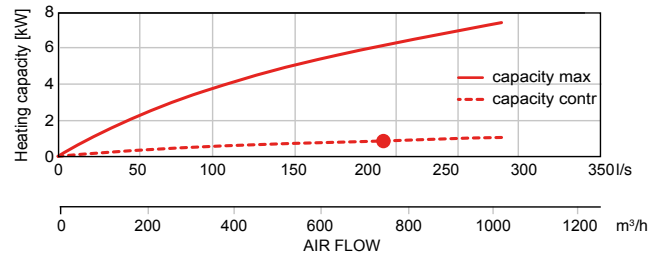

WATER COOLING COIL

Water cooling coil		Supply
Cooling medium		21% Ethylene glycol
Air volume	m ³ /h / l/s	750 / 208
Temperature at inlet (after heat recovery)	°C	27
Temperature at outlet (downstream of the cooling coil)	°C	18
Inlet relative humidity (after heat recovery)	% RH	52
Outlet relative humidity (downstream of the cooling coil)	% RH	81
Cooling capacity	kW	3.3
Condensate production	l/h	1
Water temperature drop	°C	6 / 12
Medium flow (at max. capacity)	l/h	510
Medium-side pressure drop		
in heat exchanger	kPa	39.00
in valve	kPa	0.28
Connection dimension		1" female

Note: The figures above have been measured at 750 m³/h and 200 Pa. Please use the Duplexvent Selection Software to calculate measurements at other performance levels.

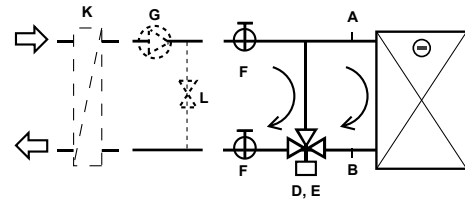

- A, B Sludge valve plug 2)
- Hydraulic kit: R-CW3.TR 24-SR**
- D 3-way ball valve R3020-B1 1)
- E Actuator TR 24-SR 1)
- F Globe valve 1" 1)

Others:

- G Pump 3)
- L Water bypass 3)
- K Coil water/ethylene glycol 3)

1 - Delivered separately
2 - Fitted and connected
3 - Not part of delivery

COOLING CAPACITY

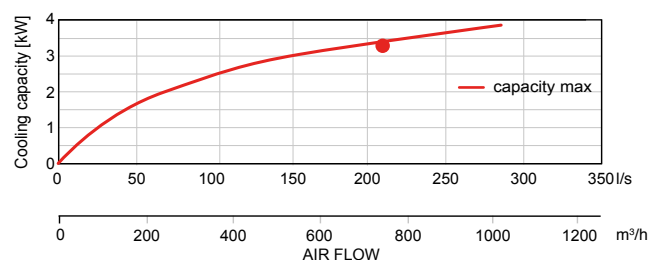

DX COIL

DX coil		Supply
Air volume	m ³ /h / l/s	750 / 208
Temperature at inlet (after heat recovery)	°C	27
Temperature at outlet (downstream of the DX coil)	°C	18
Inlet relative humidity (after heat recovery)	% RH	52
Outlet relative humidity (downstream of the DX coil)	% RH	74
Cooling capacity	kW	3.03
Condensate production	l/h	2
Refrigerant type		R410A
Evaporating temperature	°C	8

Note: The figures above have been measured at 750 m³/h and 200 Pa. Please use the Duplexvent Selection Software to calculate measurements at other performance levels.

COOLING CAPACITY

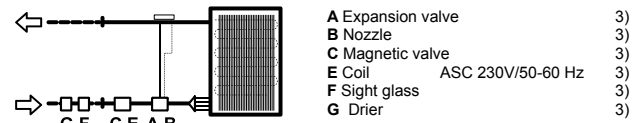
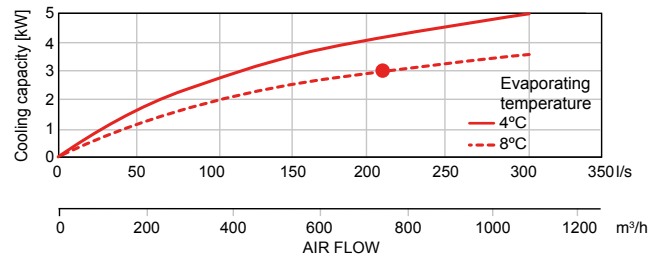

3 Not part of delivery, recommended type mentioned

DIMENSIONS

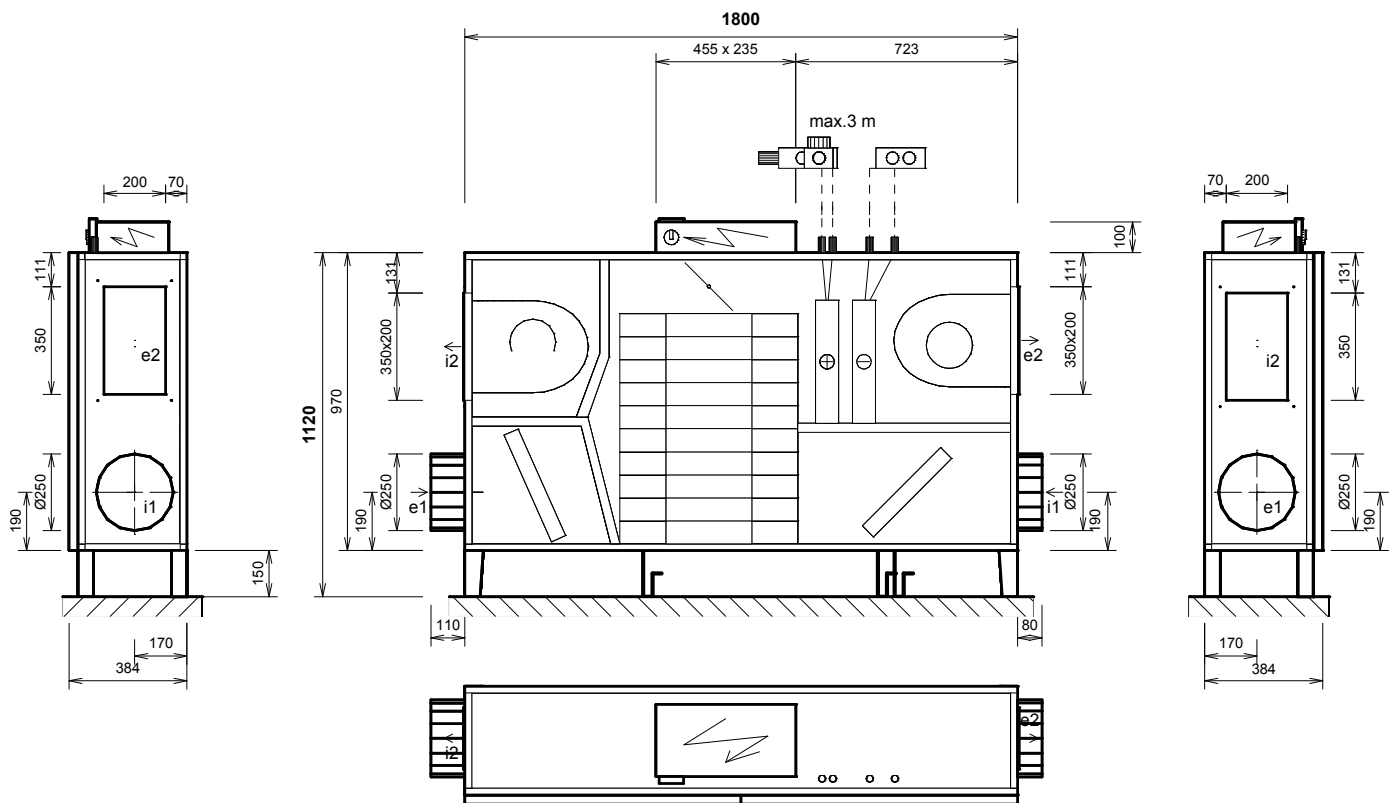

Connections	Type	Dimensions	Optional components
e1	e1- outdoor air (ODA)	Ø 250mm	Shutoff damper, Flexible connection
e2	e2- supply air (SUP)	350 x 200 mm	Flexible connection
i1	i1- extract air (ETA)	Ø 250mm	Shutoff damper, Flexible connection
i2	i2- exhaust air (EHA)	350 x 200 mm	Flexible connection
K	condensate drain	3x Ø 16 mm/22 mm	Condensate pump

Notice:

- Unit supplied as one piece
- Door - 2 parts
- Diagram is intended only for basic information, binding dimensions receive at device delivery, or on request from the manufacturer.
- Bolt holes for duct connection (for one port): 4xM6

Duplexvent Multi eco DV1100

Commercial MVHR with cross-counter-flow heat exchanger - Indoor



KEY FEATURES

- Air volume up to 900 m³/h at 200 Pa according to ErP 2018
- Digital Touchscreen or simple manual controller
- Low noise, refer to NR35 and BB93 standards
- Excellent thermal insulation (class T2, TB1)
- Filters: ePM2,5 65 % (F7), ePM10 70 % (M5) or Coarse 60 % (G4)
- Optional circulation damper
- Optional constant flow and constant pressure mode
- BREEAM and ErP 2018 compliant
- Meets Building Regulations Part L2A and L2B

PERFORMANCE

Ventilation		Supply Air	Extract Air
Air volume @ 200 Pa	m ³ /h / l/s	900 / 250	900 / 250
Nominal voltage	V	230	230
Nominal power (at operation point)	kW	0.28	0.22
Fan Speed	min ⁻¹	2986	2828
Max power input	kW	0.39	0.39
Max current	A	2.5	2.5
Fan Type		EC	EC

Note: The figures above have been measured at 900 m³/h and 200 Pa. Please use the Duplexvent Selection Software to calculate measurements at other performance levels.

AIR FLOW CURVE

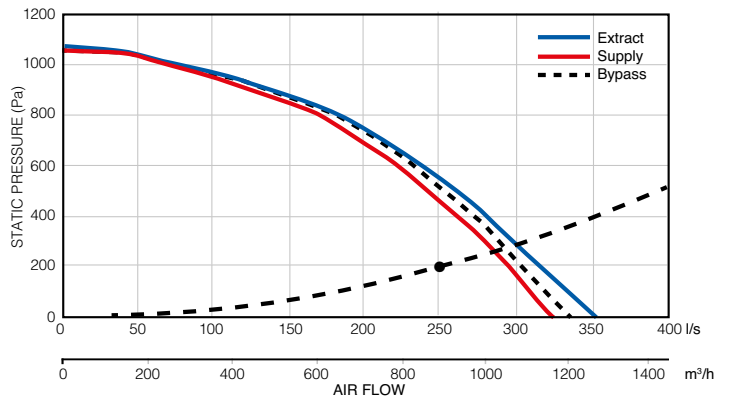

Heat Recovery		Supply Air	Extract Air
Air volume @ 200 Pa	m ³ /h / l/s	900 / 250	900 / 250
Temperature at inlet	°C	-5	20
Temperature at outlet	°C	16.3	3.3
Humidity at inlet	% RH	90	40
Humidity at outlet	% RH	19	96
Heat recovery efficiency winter / summer	%	82 / 78	
Performance in winter / summer	kW	6.4 / 1.5	
Condensation	l/h	1.4	
Type of heat exchanger		Cross-counter-flow, Plastic	
Part No.		90000792	

Note: The figures above have been measured at 900 m³/h and 200 Pa. Please use the Duplexvent Selection Software to calculate measurements at other performance levels.

POWER CONSUMPTION

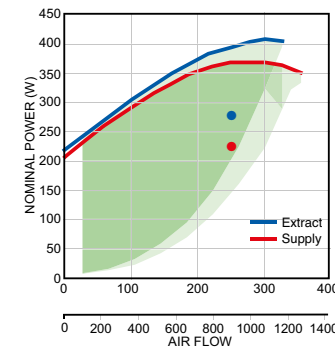

Note: Green area denotes power consumption range. Power consumption depends on system installation.

HEAT RECOVERY EFFICIENCY

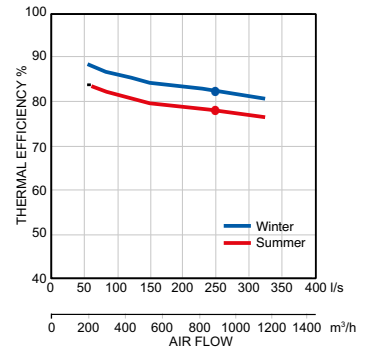

Sound Power Level L _w	Total	63 Hz	125 Hz	250 Hz	500 Hz	1 kHz	2 kHz	4 kHz	8 kHz
	dB (A)								
Outdoor air e1	54	44	43	51	45	47	39	<25	<25
Supply air e2	77	57	62	70	72	72	69	63	60
Extract air i1	58	44	40	56	51	44	37	<25	<25
Exhaust air i2	79	53	61	76	72	72	69	63	59
Breakout noise	62	42	43	54	60	55	48	29	<25
Sound Pressure Level L _p measured at 3m	42	<25	<25	34	40	34	28	<25	<25

Note: The figures above have been measured at 900 m³/h and 200 Pa. Please use the Duplexvent Selection Software to calculate measurements at other performance levels.

Winter Operation:

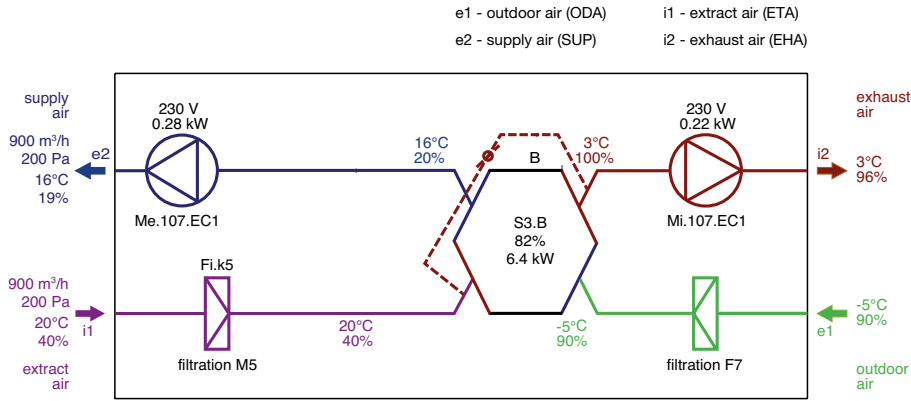

Note: AHU functions diagram. Inlet and outlet location may differ from actual position and port configuration.

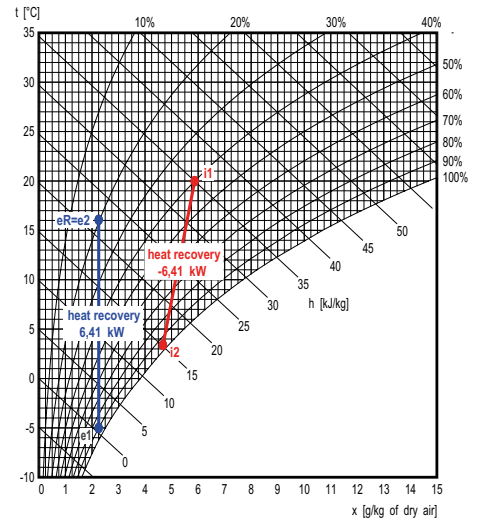

Supply

Description	t [°C]	RH [%]
e1 Outdoor Air	-5.0	90
e2 Supply Air	16.3	19

Exhaust

Description	t [°C]	RH [%]
i1 Extract Air	20.0	40
i2 Exhaust Air	3.3	96

Summer Operation:

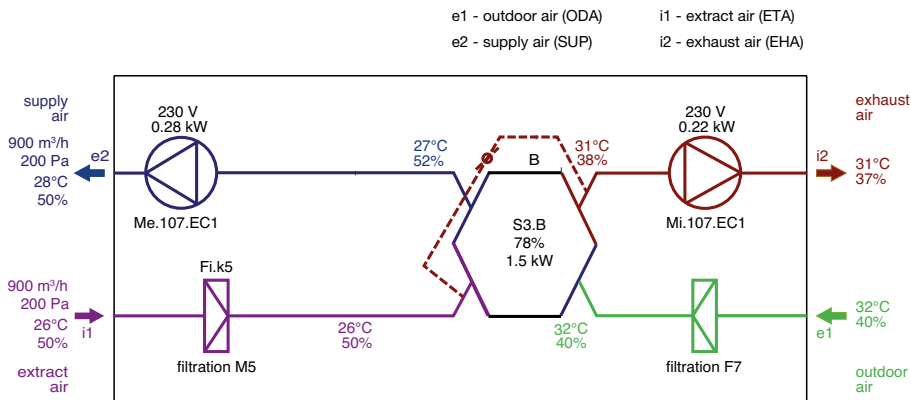

Note: AHU functions diagram. Inlet and outlet location may differ from actual position and port configuration.

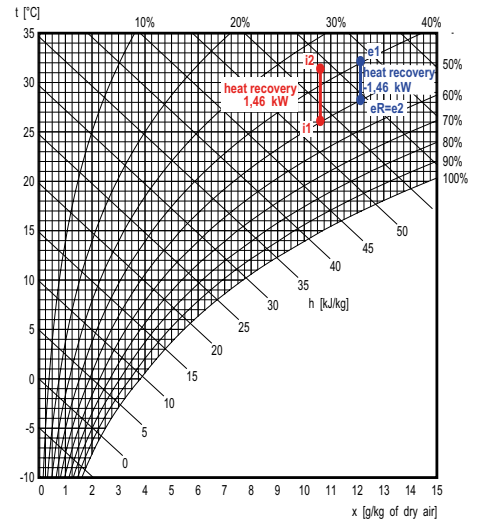

Supply

Description	t [°C]	RH [%]
e1 Outdoor Air	32.0	40
e2 Supply Air	28.1	50

Exhaust

Description	t [°C]	RH [%]
i1 Extract Air	26.0	50
i2 Exhaust Air	31.2	37

FILTERS

Filtration Type	Supply	Extract	Accessories (part of delivery)
	Pleated Cartridge		
Filtration class	ePM2,5 65 % (F7)	ePM10 70 % (M5)	Pfe dirty filter pressure switch for supply air
Number of filters	1	1	Pfi dirty filter pressure switch for extract air
Filter cartridge size	440x310x96	440x310x96	

Duplexvent Multi eco DV1100

Commercial MVHR with cross-counter-flow heat exchanger - Indoor

OPTIONAL ACCESSORIES

ELECTRIC PRE-HEATER

Electric pre-heater		Supply
Air volume	m ³ /h / l/s	900 / 250
Maximum heating capacity	kW	3.0
Voltage	V	400
Connection ports	mm	Ø 250

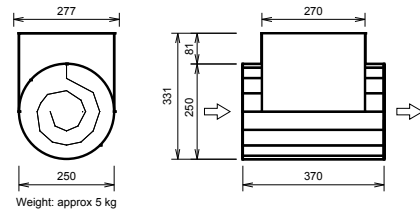

WATER HEATING COIL

Water heating coil		Supply
Heating medium		Water
Air volume	m ³ /h / l/s	900 / 250
Temperature at inlet (after heat recovery)	°C	16
Temperature at outlet (downstream of the heater)	°C	19
Heating capacity	kW	1.1
Heating medium temperature drop	°C	70/50
Medium flow (from source)	l/h	49
Connection dimension (hydraulic kit)		1" female

Note: The figures above have been measured at 900 m³/h and 200 Pa. Please use the Duplexvent Selection Software to calculate measurements at other performance levels.

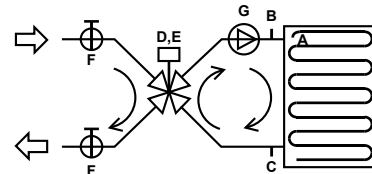

- A Freeze protection thermostat 016-H6927-107-3m 2)
- B Sludge valve plug 2)
- C Sludge valve plug 2)
- Hydraulic kit: RE-HW4.LM24A-SR
- D Mixing valve IVAR.MIX4, Kv 12, 1" 1)
- E Actuator LM24A-SR 1)
- F Globe valve 1" 1)
- G Pump WILO YONOS PARA RS 20/6- RKC 1)

1 - Delivered separately
2 - Fitted and connected

HEATING CAPACITY

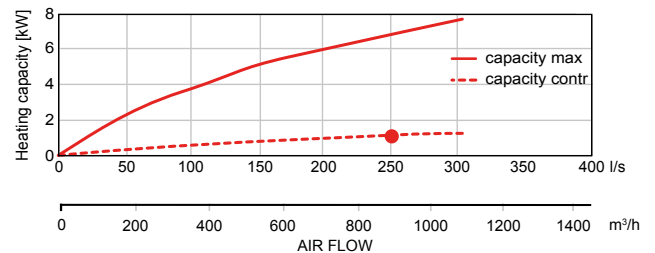

WATER COOLING COIL

Water cooling coil		Supply
Cooling medium		21% Ethylene glycol
Air volume	m ³ /h / l/s	900 / 250
Temperature at inlet (after heat recovery)	°C	27
Temperature at outlet (downstream of the cooling coil)	°C	19
Inlet relative humidity (after heat recovery)	% RH	52
Outlet relative humidity (downstream of the cooling coil)	% RH	77
Cooling capacity	kW	3.4
Condensate production	l/h	1
Water temperature drop	°C	6 / 12
Medium flow (at max. capacity)	l/h	580
Medium-side pressure drop		
in heat exchanger	kPa	48.38
in valve	kPa	0.34
Connection dimension		1" female

Note: The figures above have been measured at 900 m³/h and 200 Pa. Please use the Duplexvent Selection Software to calculate measurements at other performance levels.

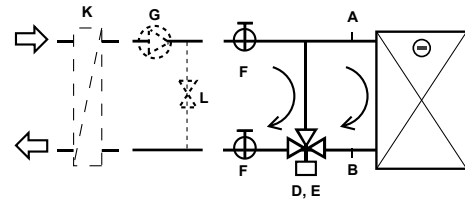

- A, B Sludge valve plug 2)
- Hydraulic kit: R-CW3.TR 24-SR
- D 3-way ball valve R3020-B1 1)
- E Actuator TR 24-SR 1)
- F Globe valve 1" 1)
- Others:
- G Pump 3)
- L Water bypass 3)
- K Coil water/ethylene glycol 3)

1 - Delivered separately
2 - Fitted and connected
3 - Not part of delivery

COOLING CAPACITY

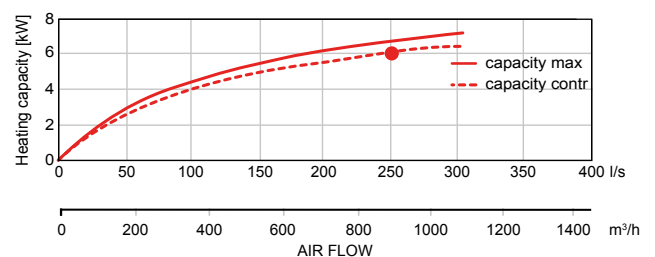

DX COIL

DX coil		Supply
Air volume	m ³ /h / l/s	900 / 250
Temperature at inlet (after heat recovery)	°C	27
Temperature at outlet (downstream of the DX coil)	°C	19
Inlet relative humidity (after heat recovery)	% RH	52
Outlet relative humidity (downstream of the DX coil)	% RH	71
Cooling capacity	kW	2.3
Condensate production	l/h	2
Refrigerant type		R410A
Evaporating temperature	°C	10

Note: The figures above have been measured at 900 m³/h and 200 Pa. Please use the Duplexvent Selection Software to calculate measurements at other performance levels.

COOLING CAPACITY

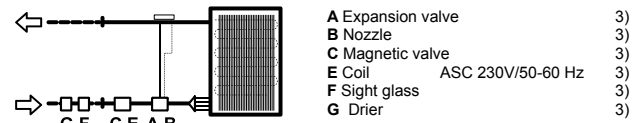
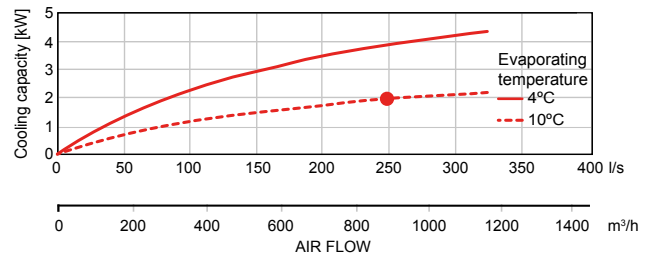

3 Not part of delivery, recommended type mentioned

DIMENSIONS

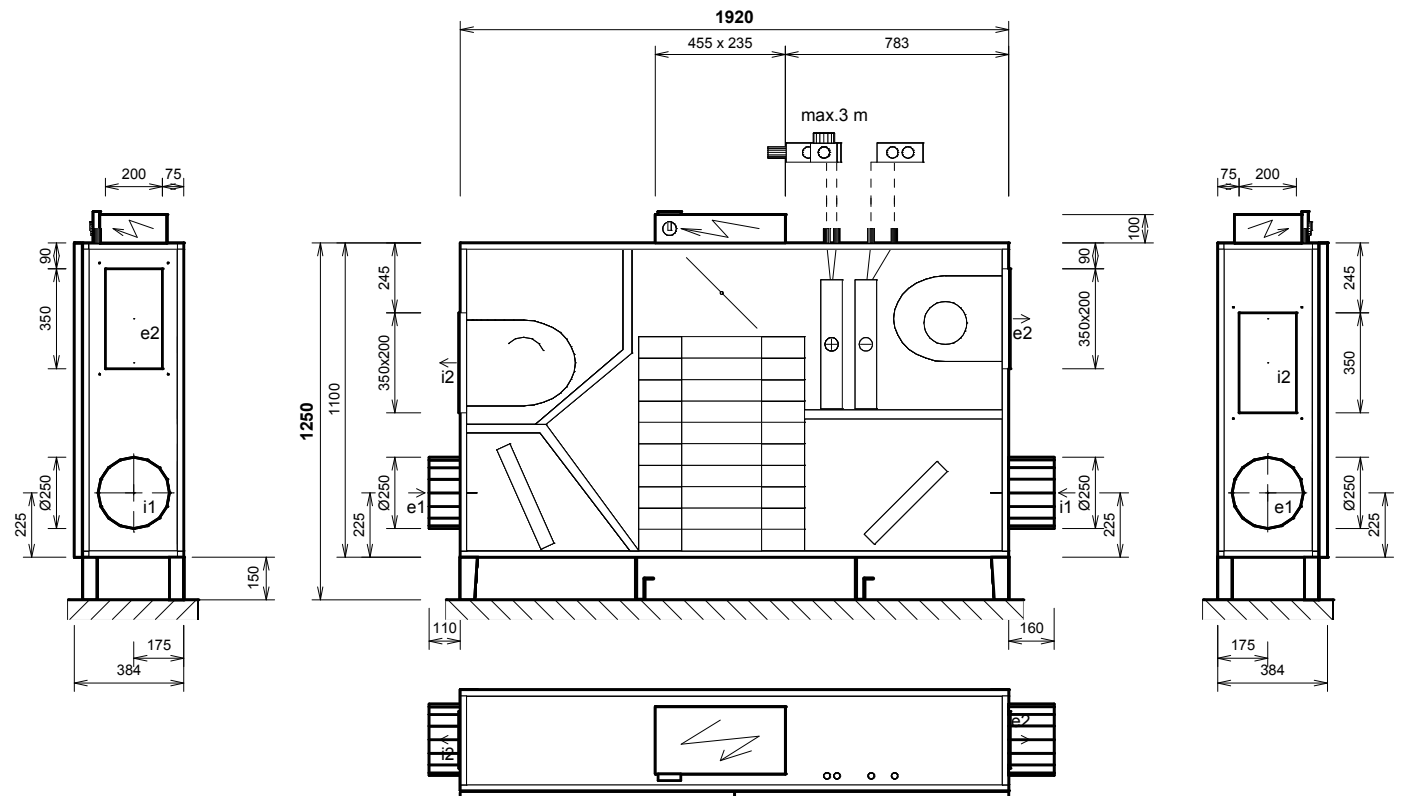

Connections	Type	Dimensions	Optional components
e1	e1- outdoor air (ODA)	Ø 250mm	Shutoff damper, Flexible connection
e2	e2- supply air (SUP)	350 x 200 mm	Flexible connection
i1	i1- extract air (ETA)	Ø 250mm	Shutoff damper, Flexible connection
i2	i2- exhaust air (EHA)	350 x 200 mm	Flexible connection
K	condensate drain	2x Ø 16 mm/22 mm	Condensate pump

Notice:

- Unit supplied as one piece
- Door - 2 parts
- Diagram is intended only for basic information, binding dimensions receive at device delivery, or on request from the manufacturer.
- Bolt holes for duct connection (for one port): 4xM6

Duplexvent Multi eco DV1500

Commercial MVHR with cross-counter-flow heat exchanger - Indoor



KEY FEATURES

- Air volume up to 1500 m³/h at 200 Pa according to ErP 2018
- Digital Touchscreen or simple manual controller
- Low noise, refer to NR35 and BB93 standards
- Excellent thermal insulation (class T2, TB1)
- Filters: ePM2,5 65 % (F7), ePM10 70 % (M5) or Coarse 60 % (G4)
- Optional circulation damper
- Optional constant flow and constant pressure mode
- BREEAM and ErP 2018 compliant
- Meets Building Regulations Part L2A and L2B

PERFORMANCE

Ventilation		Supply Air	Extract Air
Air volume @ 200 Pa	m ³ /h / l/s	1500 / 417	1500 / 417
Nominal voltage	V	230	230
Nominal power (at operation point)	kW	0.44	0.46
Fan Speed	min ⁻¹	2514	2507
Max power input	kW	0.78	0.78
Max current	A	3.9	3.9
Fan Type		EC	EC

Note: The figures above have been measured at 1500 m³/h and 200 Pa. Please use the Duplexvent Selection Software to calculate measurements at other performance levels.

AIR FLOW CURVE

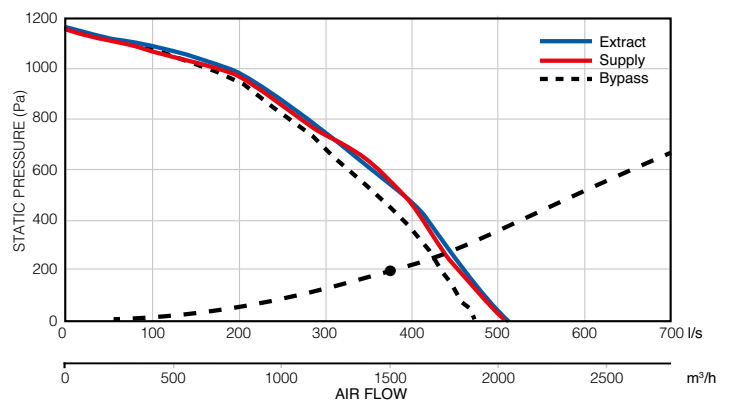

Heat Recovery		Supply Air	Extract Air
Air volume @ 200 Pa	m ³ /h / l/s	1500 / 417	1500 / 417
Temperature at inlet	°C	-5	20
Temperature at outlet	°C	17.6	2.6
Humidity at inlet	% RH	90	40
Humidity at outlet	% RH	18	95
Heat recovery efficiency winter / summer	%	88 / 83	
Performance in winter / summer	kW	11.4 / 2.6	
Condensation	l/h	2.7	
Type of heat exchanger		Cross-counter-flow, Plastic	
Part No.		90000793	

Note: The figures above have been measured at 1500 m³/h and 200 Pa. Please use the Duplexvent Selection Software to calculate measurements at other performance levels.

POWER CONSUMPTION

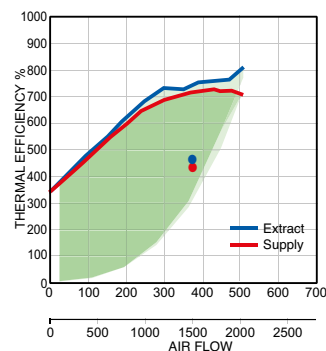

Note: Green area denotes power consumption range. Power consumption depends on system installation.

HEAT RECOVERY EFFICIENCY

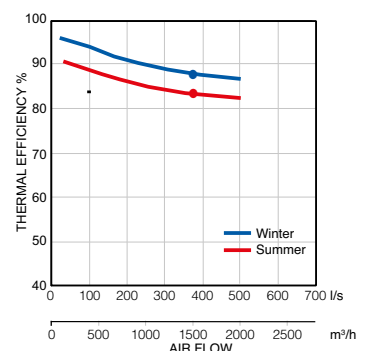

Sound Power Level L _w	Total	63 Hz	125 Hz	250 Hz	500 Hz	1 kHz	2 kHz	4 kHz	8 kHz
	dB (A)								
Outdoor air e1	61	50	53	57	51	54	52	45	29
Supply air e2	86	65	71	84	78	79	76	70	63
Extract air i1	60	49	50	58	53	50	42	37	26
Exhaust air i2	86	71	78	81	79	78	75	69	60
Breakout noise	64	49	54	60	59	54	49	34	<25
Sound Pressure Level L _p measured at 3m	43	28	33	39	39	34	29	<25	<25

Note: The figures above have been measured at 1500 m³/h and 200 Pa. Please use the Duplexvent Selection Software to calculate measurements at other performance levels.

Winter Operation:

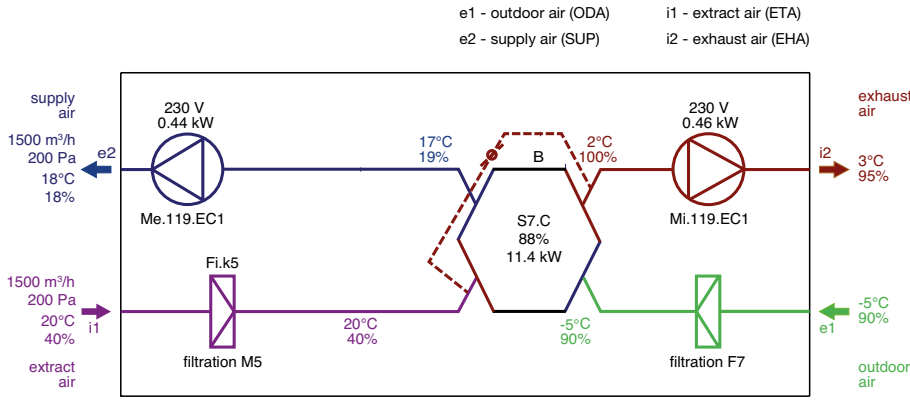

Note: AHU functions diagram. Inlet and outlet location may differ from actual position and port configuration.

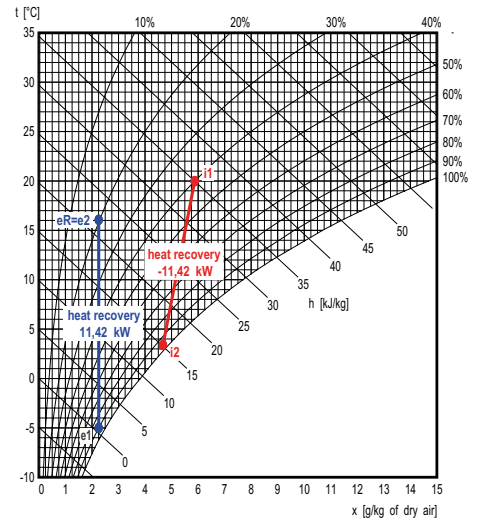

Supply

Description	t [°C]	RH [%]
e1 Outdoor Air	-5.0	90
e2 Supply Air	17.6	18

Exhaust

Description	t [°C]	RH [%]
i1 Extract Air	20.0	40
i2 Exhaust Air	2.6	95

Summer Operation:

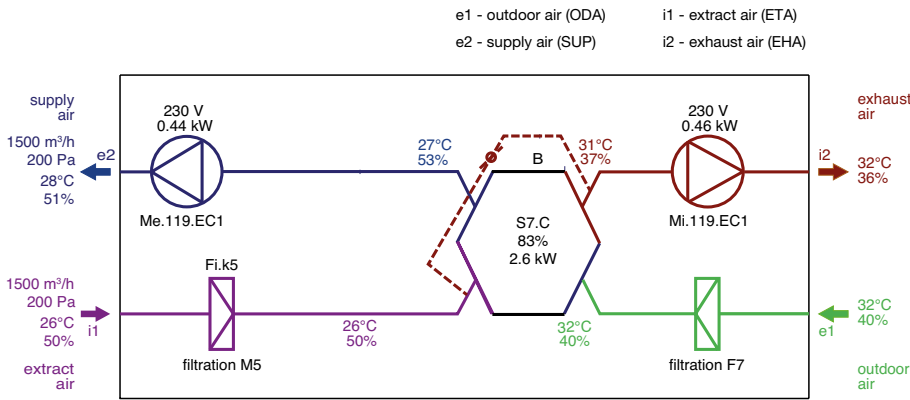

Note: AHU functions diagram. Inlet and outlet location may differ from actual position and port configuration.

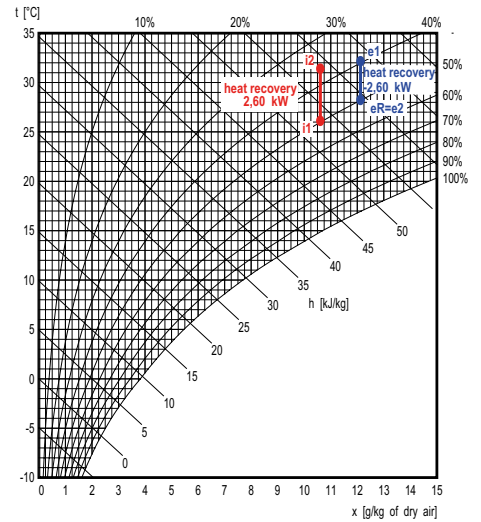

Supply

Description	t [°C]	RH [%]
e1 Outdoor Air	32.0	40
e2 Supply Air	27.8	51

Exhaust

Description	t [°C]	RH [%]
i1 Extract Air	26.0	50
i2 Exhaust Air	31.7	36

FILTERS

Filtration Type	Supply	Extract	Accessories (part of delivery)
	Pleated Cartridge		
Filtration class	ePM2,5 65 % (F7)	ePM10 70 % (M5)	Pfe dirty filter pressure switch for supply air
Number of filters	1	1	Pfi dirty filter pressure switch for extract air
Filter cartridge size	600x380x96	600x380x96	

Duplexvent Multi eco DV1500

Commercial MVHR with cross-counter-flow heat exchanger - Indoor

OPTIONAL ACCESSORIES

ELECTRIC PRE-HEATER

Electric pre-heater		Supply
Air volume	m ³ /h / l/s	1500 / 417
Maximum heating capacity	kW	6.0
Voltage	V	400
Connection ports	mm	Ø 315

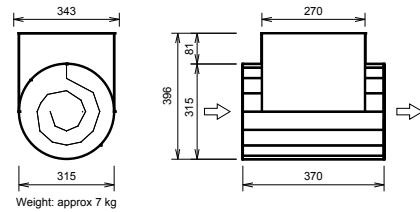

WATER HEATING COIL

Water heating coil		Supply
Heating medium		Water
Air volume	m ³ /h / l/s	1500 / 417
Temperature at inlet (after heat recovery)	°C	17
Temperature at outlet (downstream of the heater)	°C	19
Heating capacity	kW	1.1
Heating medium temperature drop	°C	70/50
Medium flow (from source)	l/h	49
Connection dimension (hydraulic kit)		1" female

Note: The figures above have been measured at 1500 m³/h and 200 Pa. Please use the Duplexvent Selection Software to calculate measurements at other performance levels.

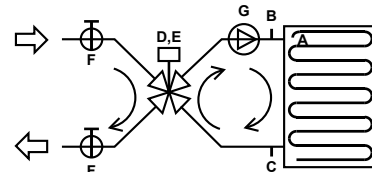

- A Freeze protection thermostat 016-H6927-107-3m 2)
- B Sludge valve plug 2)
- C Sludge valve plug 2)
- Hydraulic kit: RE-HW4.LM24A-SR**
- D Mixing valve IVAR.MIX4, Kv 12, 1" 1)
- E Actuator LM24A-SR 1)
- F Globe valve 1" 1)
- G Pump WILO YONOS PARA RS 20/6- RKC 1)

1 - Delivered separately
2 - Fitted and connected

HEATING CAPACITY

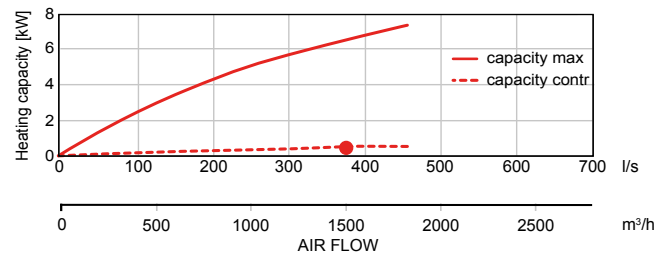

WATER COOLING COIL

Water cooling coil		Supply
Cooling medium		21% Ethylene glycol
Air volume	m ³ /h / l/s	1500 / 417
Temperature at inlet (after heat recovery)	°C	27
Temperature at outlet (downstream of the cooling coil)	°C	16
Inlet relative humidity (after heat recovery)	% RH	53
Outlet relative humidity (downstream of the cooling coil)	% RH	87
Cooling capacity	kW	8.0
Condensate production	l/h	4
Water temperature drop	°C	6 / 12
Medium flow (at max. capacity)	l/h	1360
Medium-side pressure drop		
in heat exchanger	kPa	28.53
in valve	kPa	1.83
Connection dimension		1" female

Note: The figures above have been measured at 1500 m³/h and 200 Pa. Please use the Duplexvent Selection Software to calculate measurements at other performance levels.

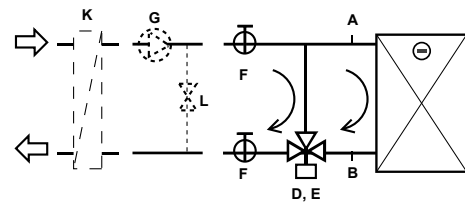

- A, B Sludge valve plug 2)
- Hydraulic kit: R-CW3.TR 24-SR**
- D 3-way ball valve R3020-B1 1)
- E Actuator TR 24-SR 1)
- F Globe valve 1" 1)
- Others:**
- G Pump 3)
- L Water bypass 3)
- K Coil water/ethylene glycol 3)

1 - Delivered separately
2 - Fitted and connected
3 - Not part of delivery

COOLING CAPACITY

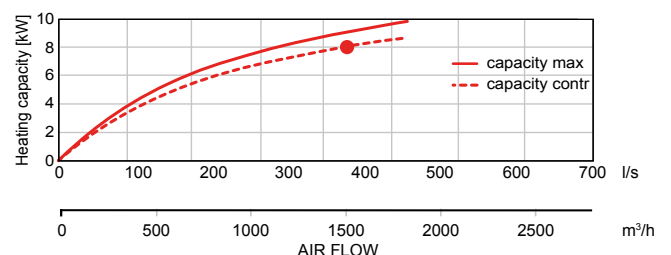

DX COIL

DX coil		Supply
Air volume	m ³ /h / l/s	1500 / 417
Temperature at inlet (after heat recovery)	°C	27
Temperature at outlet (downstream of the DX coil)	°C	16
Inlet relative humidity (after heat recovery)	% RH	53
Outlet relative humidity (downstream of the DX coil)	% RH	80
Cooling capacity	kW	8.0
Condensate production	l/h	5
Refrigerant type		R410A
Evaporating temperature	°C	7

Note: The figures above have been measured at 1500 m³/h and 200 Pa. Please use the Duplexvent Selection Software to calculate measurements at other performance levels.

COOLING CAPACITY

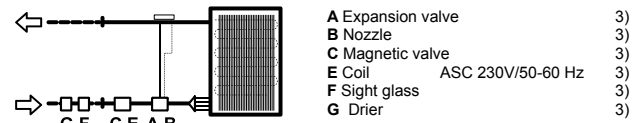
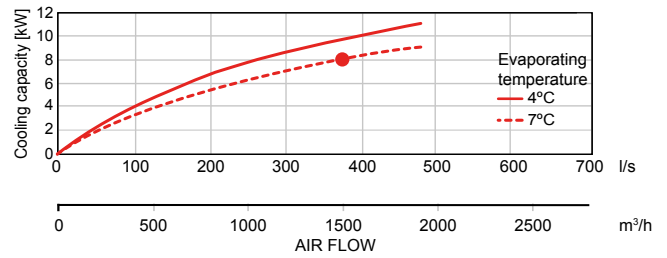

3 Not part of delivery, recommended type mentioned

DIMENSIONS

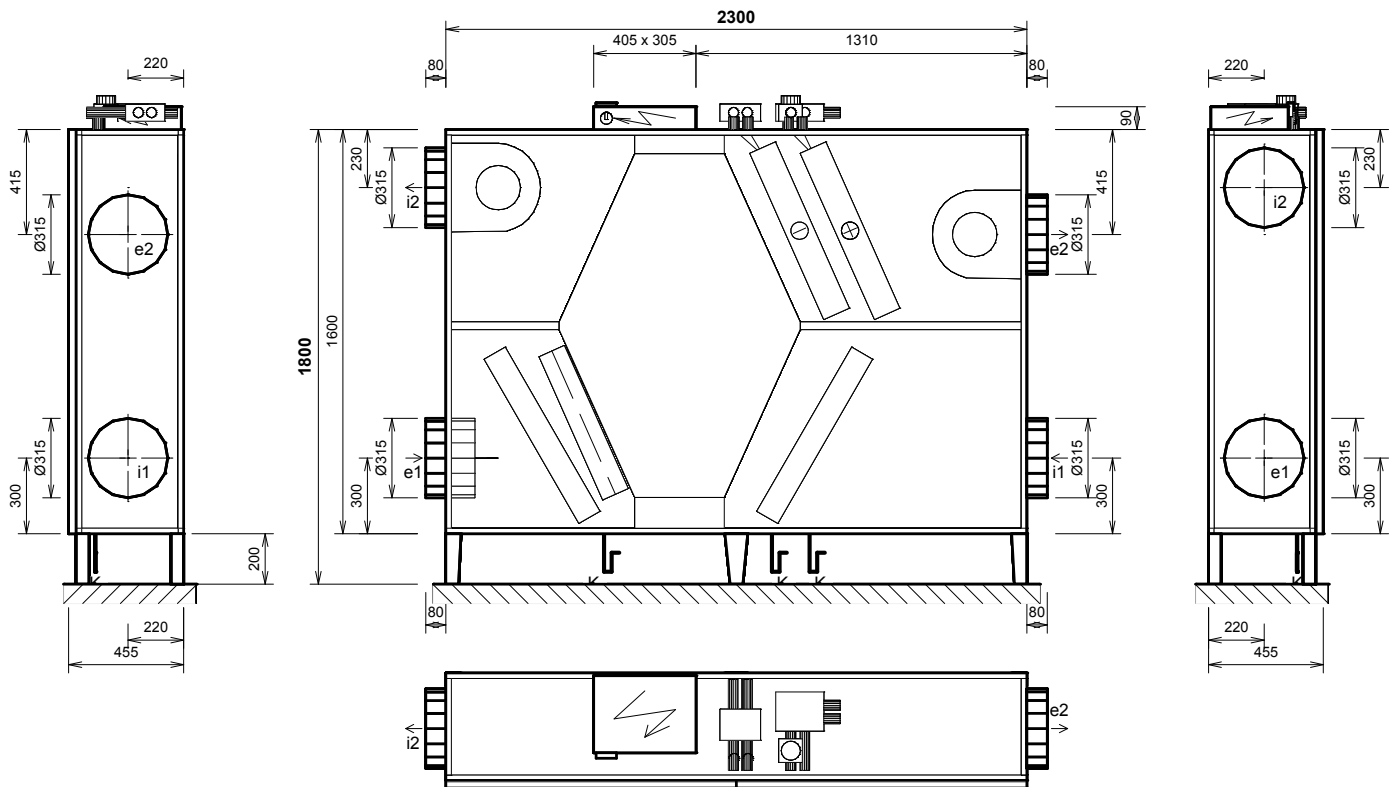

Connections	Type	Dimensions	Optional components
e1	e1- outdoor air (ODA)	Ø 315mm	Shutoff damper, Flexible connection
e2	e2- supply air (SUP)	Ø 315mm	Flexible connection
i1	i1- extract air (ETA)	Ø 315mm	Shutoff damper, Flexible connection
i2	i2- exhaust air (EHA)	Ø 315mm	Flexible connection
K	condensate drain	3x Ø 32 mm/40 mm	Condensate pump

Notice:

- Unit supplied as one piece
- Door - 2 parts
- Diagram is intended only for basic information, binding dimensions receive at device delivery, or on request from the manufacturer.

Duplexvent Multi eco DV2500

Commercial MVHR with cross-counter-flow heat exchanger - Indoor



PERFORMANCE

Ventilation		Supply Air	Extract Air
Air volume @ 200 Pa	m ³ /h / l/s	2300 / 639	2300 / 639
Nominal voltage	V	400	400
Nominal power (at operation point)	kW	0.65	0.63
Fan Speed	min ⁻¹	2312	2237
Max power input	kW	2.5	2.5
Max current	A	4	4
Fan Type		EC	EC

Note: The figures above have been measured at 2300 m³/h and 200 Pa. Please use the Duplexvent Selection Software to calculate measurements at other performance levels.

Heat Recovery		Supply Air	Extract Air
Air volume @ 200 Pa	m ³ /h / l/s	2300 / 639	2300 / 639
Temperature at inlet	°C	-5	20
Temperature at outlet	°C	17.4	2.6
Humidity at inlet	% RH	90	40
Humidity at outlet	% RH	18	96
Heat recovery efficiency winter / summer	%	87 / 83	
Performance in winter / summer	kW	17.3 / 3.9	
Condensation	l/h	4.1	
Type of heat exchanger		Cross-counter-flow, Plastic	
Part No.		90000794	

Note: The figures above have been measured at 2300 m³/h and 200 Pa. Please use the Duplexvent Selection Software to calculate measurements at other performance levels.

Sound Power Level L _w	Total	63 Hz	125 Hz	250 Hz	500 Hz	1 kHz	2 kHz	4 kHz	8 kHz
	dB (A)								
Outdoor air e1	58	47	53	55	46	43	37	28	<25
Supply air e2	78	57	63	72	70	72	71	67	59
Extract air i1	52	36	44	49	44	42	37	29	<25
Exhaust air i2	75	52	60	69	65	70	68	62	54
Breakout noise	64	36	43	62	59	54	49	44	30
Sound Pressure Level L _p measured at 3m	44	<25	<25	41	38	33	28	<25	<25

Note: The figures above have been measured at 2300 m³/h and 200 Pa. Please use the Duplexvent Selection Software to calculate measurements at other performance levels.

KEY FEATURES

- Air volume up to 2300 m³/h at 200 Pa according to ErP 2018
- Digital Touchscreen or simple manual controller
- Low noise, refer to NR35 and BB93 standards
- Excellent thermal insulation (class T2, TB1)
- Filters: ePM2,5 65 % (F7), ePM10 70 % (M5) or Coarse 60 % (G4)
- Optional circulation damper
- Optional constant flow and constant pressure mode
- BREEAM and ErP 2018 compliant
- Meets Building Regulations Part L2A and L2B

AIR FLOW CURVE

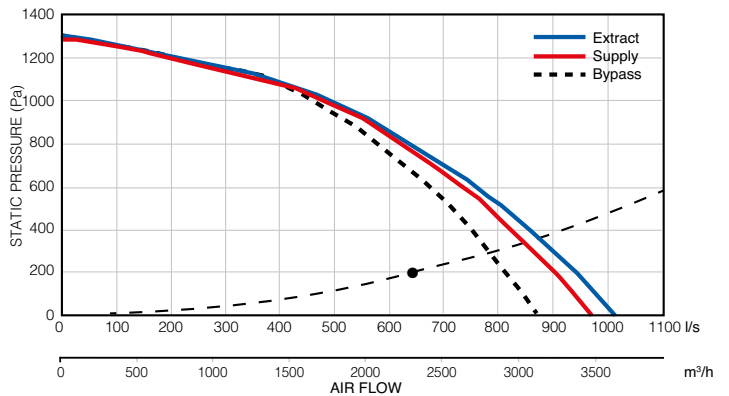

POWER CONSUMPTION

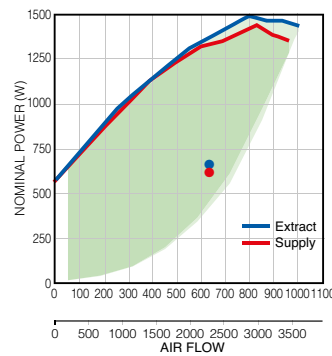

Note: Green area denotes power consumption range. Power consumption depends on system installation.

HEAT RECOVERY EFFICIENCY

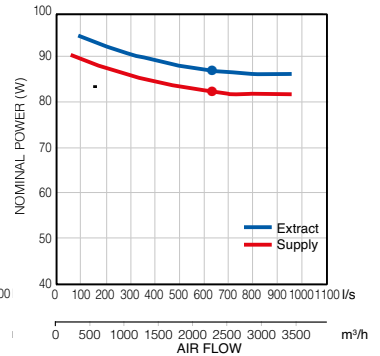

Winter Operation:

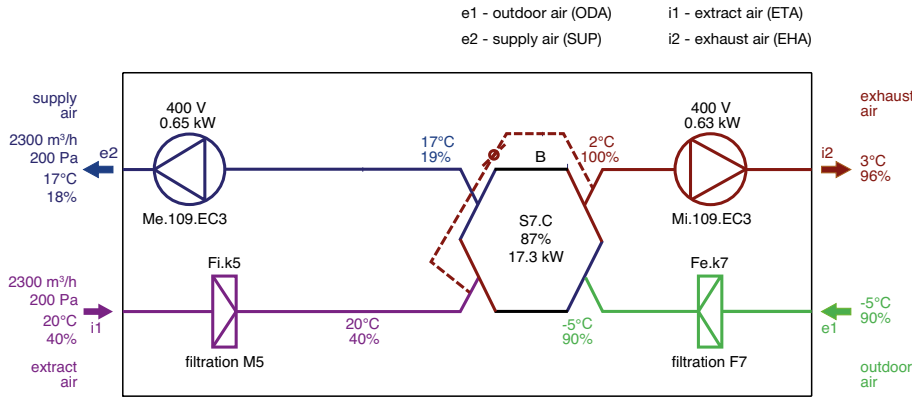

Note: AHU functions diagram. Inlet and outlet location may differ from actual position and port configuration.

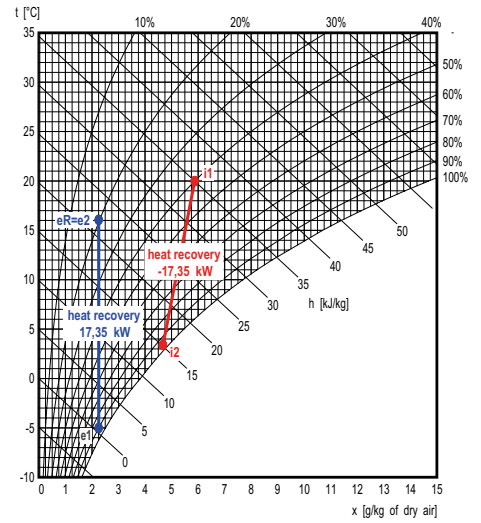

Supply

Description	t [°C]	RH [%]
e1 Outdoor Air	-5.0	90
e2 Supply Air	17.4	18

Exhaust

Description	t [°C]	RH [%]
i1 Extract Air	20.0	40
i2 Exhaust Air	2.6	96

Summer Operation:

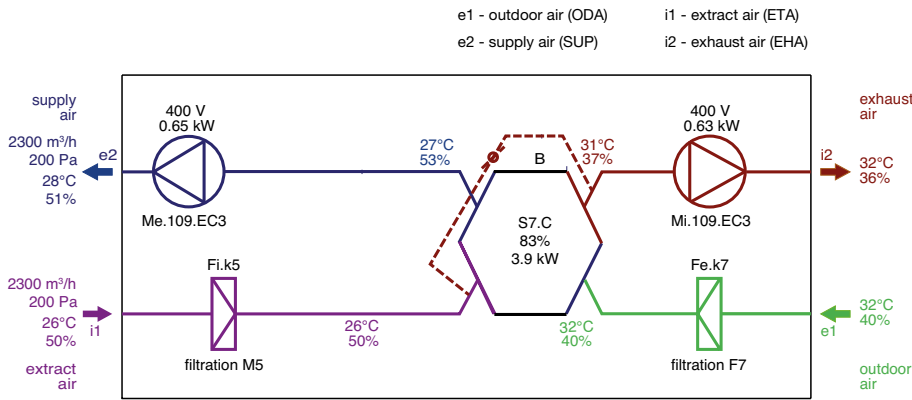

Note: AHU functions diagram. Inlet and outlet location may differ from actual position and port configuration.

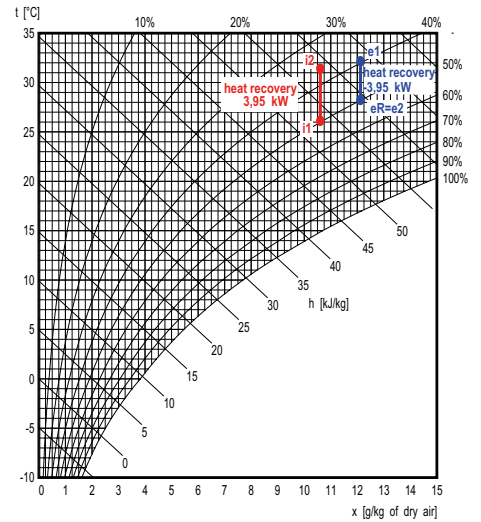

Supply

Description	t [°C]	RH [%]
e1 Outdoor Air	32.0	40
e2 Supply Air	27.8	51

Exhaust

Description	t [°C]	RH [%]
i1 Extract Air	26.0	50
i2 Exhaust Air	31.6	36

FILTERS

Filtration Type	Supply	Extract	Accessories (part of delivery)
	Pleated Cartridge		
Filtration class	F7	M5	Pfe dirty filter pressure switch for supply air
Number of filters	1	1	Pfi dirty filter pressure switch for extract air
Filter cartridge size	750x495x96	750x495x96	

Duplexvent Multi eco DV2500

Commercial MVHR with cross-counter-flow heat exchanger - Indoor

OPTIONAL ACCESSORIES

ELECTRIC PRE-HEATER

Electric pre-heater		Supply
Air volume	m ³ /h / l/s	2300 / 639
Maximum heating capacity	kW	6.0
Voltage	V	400
Connection ports	mm	500 x 250

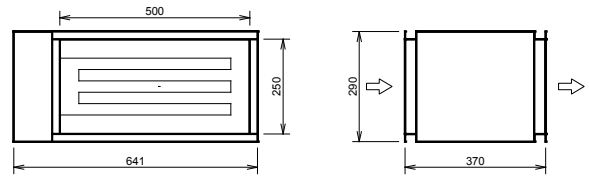

Weight: approx. 19 kg

WATER HEATING COIL

Water heating coil		Supply
Heating medium		Water
Air volume	m ³ /h / l/s	2300 / 639
Temperature at inlet (after heat recovery)	°C	17
Temperature at outlet (downstream of the heater)	°C	19
Heating capacity	kW	1.9
Heating medium temperature drop	°C	70/50
Medium flow (from source)	l/h	81
Connection dimension (hydraulic kit)		1" female

Note: The figures above have been measured at 2300 m³/h and 200 Pa. Please use the Duplexvent Selection Software to calculate measurements at other performance levels.

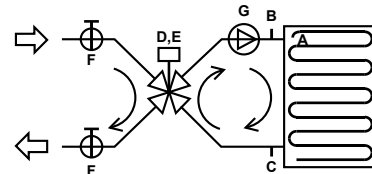

- A Freeze protection thermostat 016-H6927-107-3m 2)
- B Sludge valve plug 2)
- C Sludge valve plug 2)
- Hydraulic kit: RE-HW4.LM24A-SR**
- D Mixing valve IVAR.MIX4, Kv 12, 1" 1)
- E Actuator LM24A-SR 1)
- F Globe valve 1" 1)
- G Pump WILO YONOS PARA RS 20/6- RKC 1)

1 - Delivered separately
2 - Fitted and connected

HEATING CAPACITY

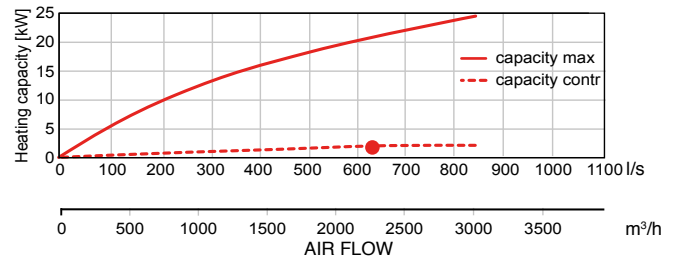

WATER COOLING COIL

Water cooling coil		Supply
Cooling medium		21% Ethylene glycol
Air volume	m ³ /h / l/s	2300 / 639
Temperature at inlet (after heat recovery)	°C	27
Temperature at outlet (downstream of the cooling coil)	°C	16
Inlet relative humidity (after heat recovery)	% RH	53
Outlet relative humidity (downstream of the cooling coil)	% RH	86
Cooling capacity	kW	12.6
Condensate production	l/h	6
Water temperature drop	°C	6 / 12
Medium flow (at max. capacity)	l/h	2170
Medium-side pressure drop		
in heat exchanger	kPa	35.74
in valve	kPa	4.6
Connection dimension		1" female

Note: The figures above have been measured at 2300 m³/h and 200 Pa. Please use the Duplexvent Selection Software to calculate measurements at other performance levels.

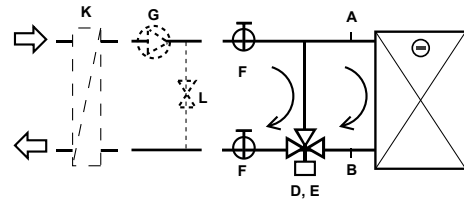

- A, B Sludge valve plug 2)
- Hydraulic kit: R-CW3.TR 24-SR**
- D 3-way ball valve R3020-B1 2)
- E Actuator TR 24-SR 2)
- F Globe valve 1" 2)
- Others:**
- G Pump 3)
- L Water bypass 3)
- K Coil water/ethylene glycol 3)

1 - Delivered separately
2 - Fitted and connected
3 - Not part of delivery

COOLING CAPACITY

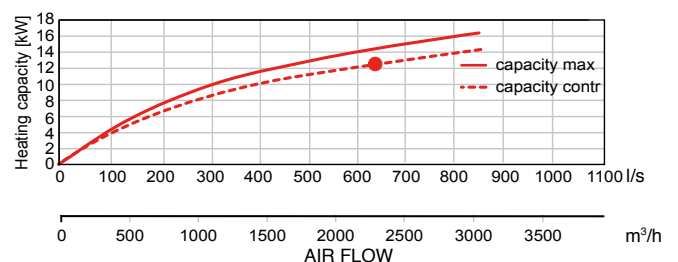

DX COIL

DX coil		Supply
Air volume	m ³ /h / l/s	2300 / 639
Temperature at inlet (after heat recovery)	°C	27
Temperature at outlet (downstream of the DX coil)	°C	16
Inlet relative humidity (after heat recovery)	% RH	53
Outlet relative humidity (downstream of the DX coil)	% RH	78
Cooling capacity	kW	11.7
Condensate production	l/h	7
Refrigerant type		R410A
Evaporating temperature	°C	4

Note: The figures above have been measured at 2300 m³/h and 200 Pa. Please use the Duplexvent Selection Software to calculate measurements at other performance levels.

COOLING CAPACITY

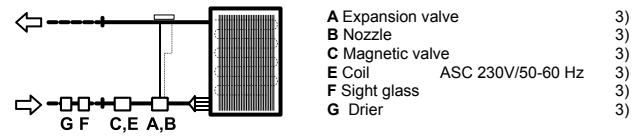
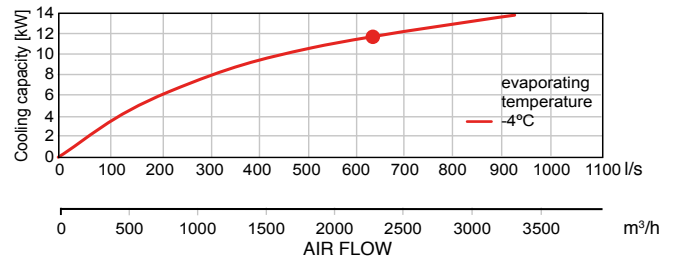

3 Not part of delivery, recommended type mentioned

DIMENSIONS

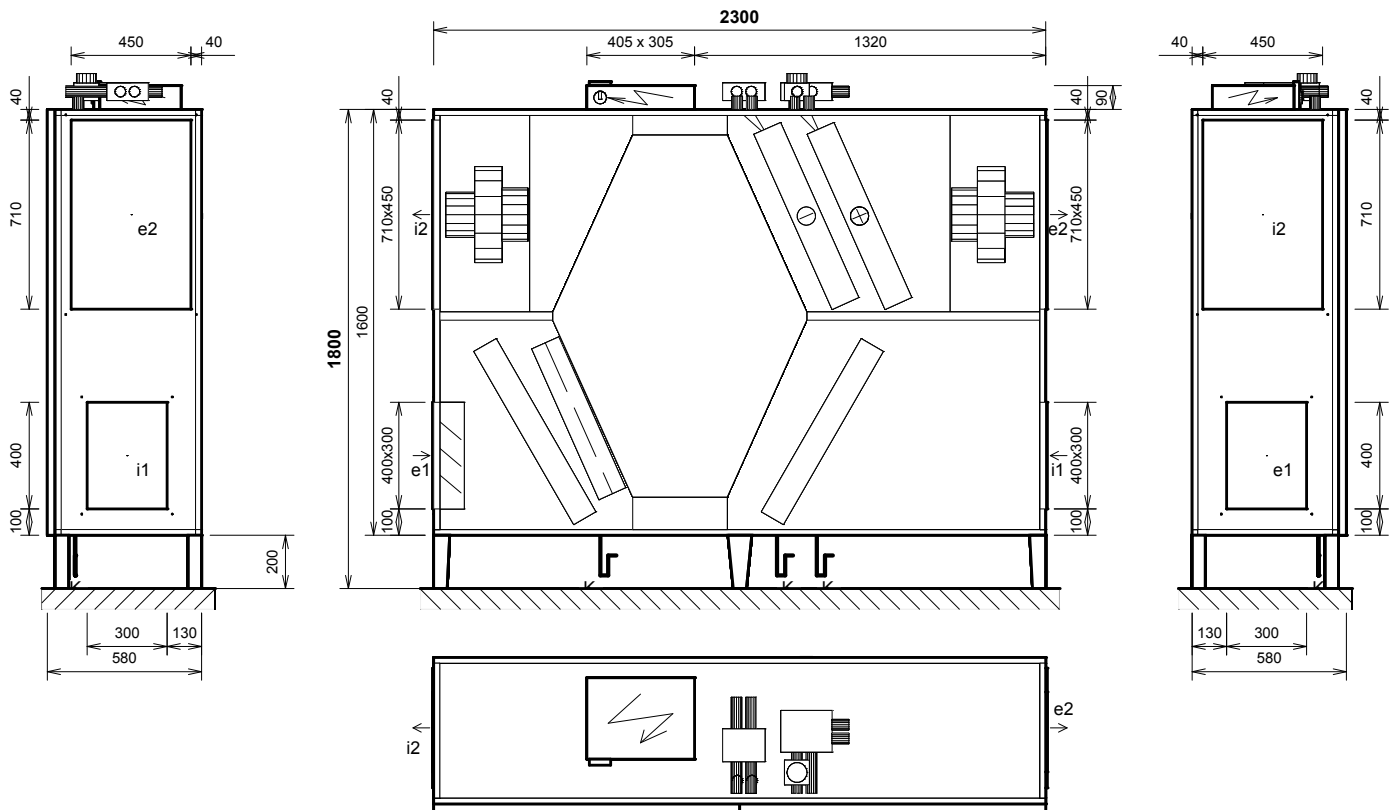

Connections	Type	Dimensions	Optional components
e1	e1- outdoor air (ODA)	400 x 300 mm	Shutoff damper, Flexible connection
e2	e2- supply air (SUP)	710 x 450 mm	Flexible connection
i1	i1- extract air (ETA)	400 x 300 mm	Shutoff damper, Flexible connection
i2	i2- exhaust air (EHA)	710 x 450 mm	Flexible connection
K	condensate drain	3x Ø 32 mm/40 mm	Condensate pump

Notice:

- Unit supplied as one piece
- Door - 2 parts
- Diagram is intended only for basic information, binding dimensions receive at device delivery, or on request from the manufacturer.
- Bolt holes for duct connection (for one port): 4 x M6

Duplexvent Multi eco DV3500

Commercial MVHR with cross-counter-flow heat exchanger - Indoor



KEY FEATURES

- Air volume up to 3300 m³/h at 200 Pa according to ErP 2018
- Digital Touchscreen or simple manual controller
- Low noise, refer to NR35 and BB93 standards
- Excellent thermal insulation (class T2, TB1)
- Filters: ePM2,5 65 % (F7), ePM10 70 % (M5) or Coarse 60 % (G4)
- Optional circulation damper
- Optional constant flow and constant pressure mode
- BREEAM and ErP 2018 compliant
- Meets Building Regulations Part L2A and L2B

PERFORMANCE

Ventilation		Supply Air	Extract Air
Air volume @ 200 Pa	m ³ /h / l/s	3300 / 917	3300 / 917
Nominal voltage	V	400	400
Nominal power (at operation point)	kW	0.87	0.8
Fan Speed	min ⁻¹	2093	2012
Max power input	kW	2.5	2.5
Max current	A	3.8	3.8
Fan Type		EC	EC

Note: The figures above have been measured at 3300 m³/h and 200 Pa. Please use the Duplexvent Selection Software to calculate measurements at other performance levels.

AIR FLOW CURVE

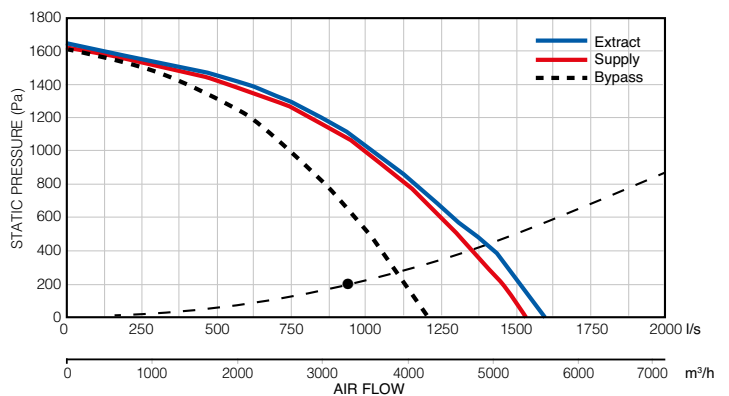

Heat Recovery		Supply Air	Extract Air
Air volume @ 200 Pa	m ³ /h / l/s	3300 / 917	3300 / 917
Temperature at inlet	°C	-5	20
Temperature at outlet	°C	17.4	2.6
Humidity at inlet	% RH	90	40
Humidity at outlet	% RH	18	96
Heat recovery efficiency winter / summer	%	87 / 82	
Performance in winter / summer	kW	24.7 / 5.6	
Condensation	l/h	5.8	
Type of heat exchanger		Cross-counter-flow, Plastic	
Part No.		90000795	

Note: The figures above have been measured at 3300 m³/h and 200 Pa. Please use the Duplexvent Selection Software to calculate measurements at other performance levels.

POWER CONSUMPTION

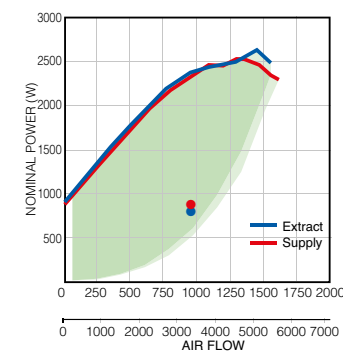

Note: Green area denotes power consumption range. Power consumption depends on system installation.

HEAT RECOVERY EFFICIENCY

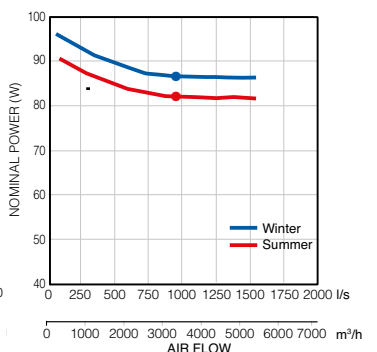

Sound Power Level L _w	Total	63 Hz	125 Hz	250 Hz	500 Hz	1 kHz	2 kHz	4 kHz	8 kHz
	dB (A)								
Outdoor air e1	63	44	51	60	58	53	44	40	28
Supply air e2	90	67	74	82	86	84	78	71	61
Extract air i1	61	40	51	54	59	47	39	27	<25
Exhaust air i2	88	63	71	81	85	82	75	68	59
Breakout noise	71	44	52	68	65	62	60	53	44
Sound Pressure Level L _p measured at 3m	51	<25	32	48	45	41	39	33	<25

Note: The figures above have been measured at 3300 m³/h and 200 Pa. Please use the Duplexvent Selection Software to calculate measurements at other performance levels.

Winter Operation:

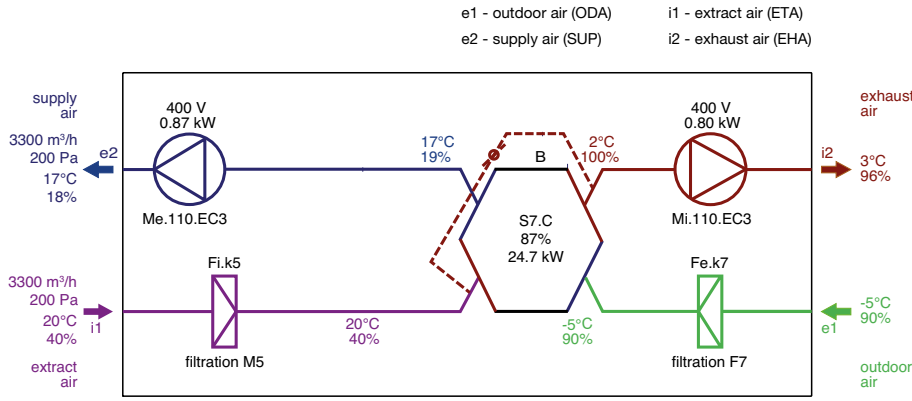

Note: AHU functions diagram. Inlet and outlet location may differ from actual position and port configuration.

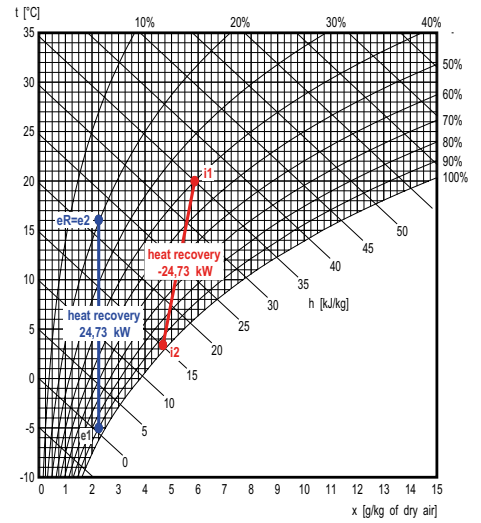

Supply

	Description	t [°C]	RH [%]
e1	Outdoor Air	-5.0	90
e2	Supply Air	17.4	18

Exhaust

	Description	t [°C]	RH [%]
i1	Extract Air	20.0	40
i2	Exhaust Air	2.6	96

Summer Operation:

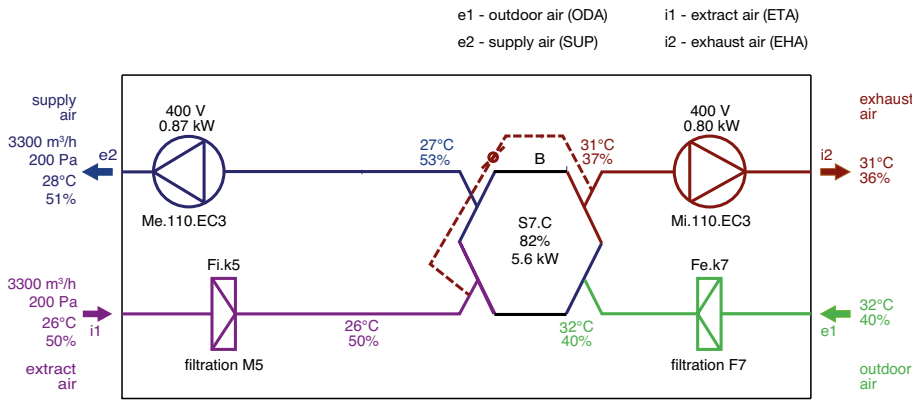

Note: AHU functions diagram. Inlet and outlet location may differ from actual position and port configuration.

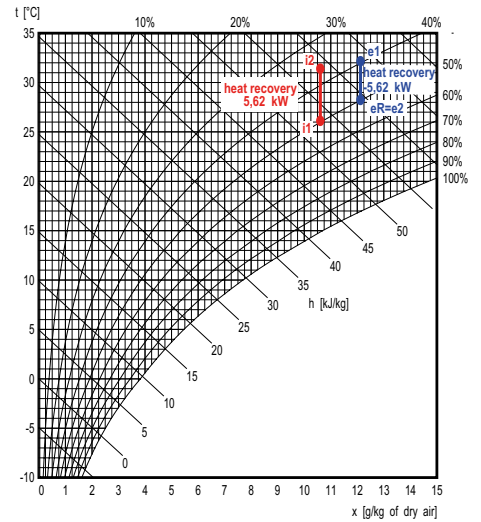

Supply

	Description	t [°C]	RH [%]
e1	Outdoor Air	32.0	40
e2	Supply Air	27.8	51

Exhaust

	Description	t [°C]	RH [%]
i1	Extract Air	26.0	50
i2	Exhaust Air	31.6	36

FILTERS

Filtration	Supply	Extract	Accessories (part of delivery)
Type	Pleated Cartridge		Pfe dirty filter pressure switch for supply air Pfi dirty filter pressure switch for extract air
Filtration class	ePM2,5 65 % (F7)	ePM10 70 % (M5)	
Number of filters	pcs 1+1	1+1	
Filter cartridge size	mm 750x295x96 750x405x96	750x295x96 750x405x96	

Duplexvent Multi eco DV3500

Commercial MVHR with cross-counter-flow heat exchanger - Indoor

OPTIONAL ACCESSORIES

ELECTRIC PRE-HEATER

Electric pre-heater		Supply
Air volume	m ³ /h / l/s	3300 / 917
Maximum heating capacity	kW	9.0
Voltage	V	400
Connection ports	mm	600x300

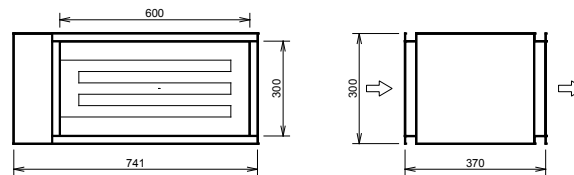

Weight: approx. 38 kg

WATER HEATING COIL

Water heating coil		Supply
Heating medium		Water
Air volume	m ³ /h / l/s	3300 / 917
Temperature at inlet (after heat recovery)	°C	17
Temperature at outlet (downstream of the heater)	°C	19
Heating capacity	kW	2.9
Heating medium temperature drop	°C	70/50
Medium flow (from source)	l/h	125
Connection dimension (hydraulic kit)		1" female

Note: The figures above have been measured at 3300 m³/h and 200 Pa. Please use the Duplexvent Selection Software to calculate measurements at other performance levels.

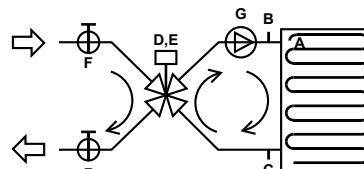

- A Freeze protection thermostat 016-H6929-109-6m 2)
- B Sludge valve plug 2)
- C Sludge valve plug 2)
- Hydraulic kit: RE-TPO4.E.LM24A-SR
- D Mixing valve IVAR.MIX4, Kv 12, 1" 2)
- E Actuator LM24A-SR 2)
- F Globe valve 1" 2)
- G Pump WILO YONOS PARA RS 20/6- RKC 2)

- 1 - Delivered separately
- 2 - Fitted and connected

HEATING CAPACITY

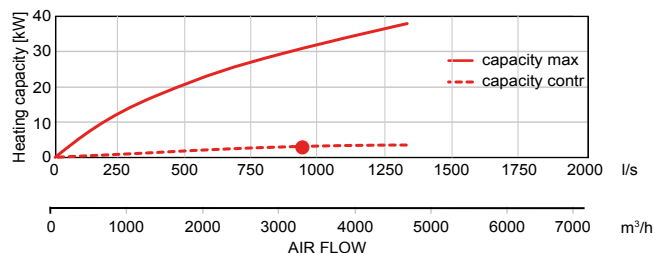

WATER COOLING COIL

Water cooling coil		Supply
Cooling medium		21% Ethylene glycol
Air volume	m ³ /h / l/s	3300 / 917
Temperature at inlet (after heat recovery)	°C	27
Temperature at outlet (downstream of the cooling coil)	°C	16
Inlet relative humidity (after heat recovery)	% RH	53
Outlet relative humidity (downstream of the cooling coil)	% RH	88
Cooling capacity	kW	17.3
Condensate production	l/h	8
Water temperature drop	°C	6 / 12
Medium flow (at max. capacity)	l/h	2850
Medium-side pressure drop		
in heat exchanger	kPa	23.1
in valve	kPa	7.94
Connection dimension		1" female

Note: The figures above have been measured at 3300 m³/h and 200 Pa. Please use the Duplexvent Selection Software to calculate measurements at other performance levels.

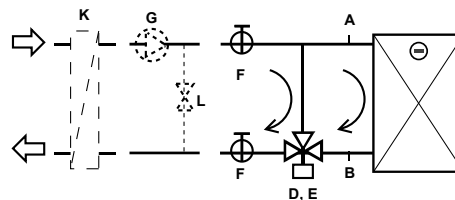

- A, B Sludge valve plug 2)
- Hydraulic kit: R-CHW3.E.TR 24-SR
- D 3-way ball valve R3020-B1 2)
- E Actuator TR 24-SR 2)
- F Globe valve 1" 2)

- Others:
- G Pump 3)
- L Water bypass 3)
- K Coil water/ethylene glycol 3)

- 1 - Delivered separately
- 2 - Fitted and connected
- 3 - Not part of delivery

COOLING CAPACITY

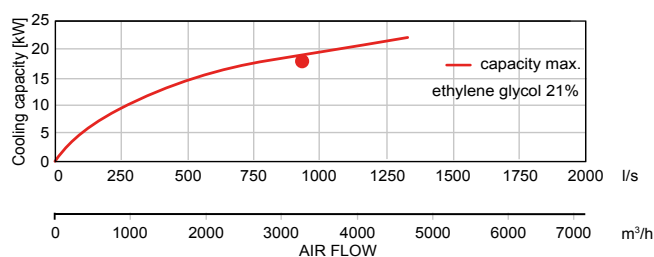

DX COIL

DX coil		Supply
Air volume	m ³ /h / l/s	3300 / 917
Temperature at inlet (after heat recovery)	°C	27
Temperature at outlet (downstream of the DX coil)	°C	18
Inlet relative humidity (after heat recovery)	% RH	53
Outlet relative humidity (downstream of the DX coil)	% RH	78
Cooling capacity	kW	16.3
Condensate production	l/h	9
Refrigerant type		R410A
Evaporating temperature	°C	4

Note: The figures above have been measured at 3300 m³/h and 200 Pa. Please use the Duplexvent Selection Software to calculate measurements at other performance levels.

COOLING CAPACITY

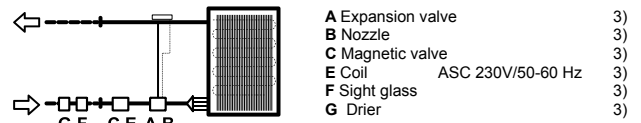
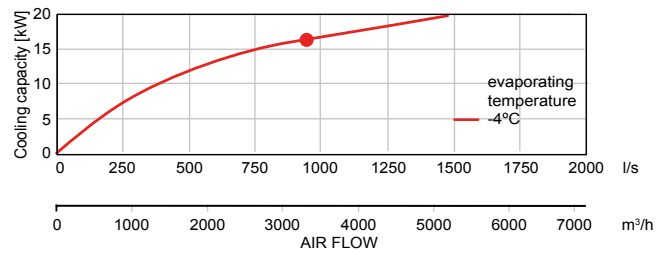

3 Not part of delivery, recommended type mentioned

DIMENSIONS

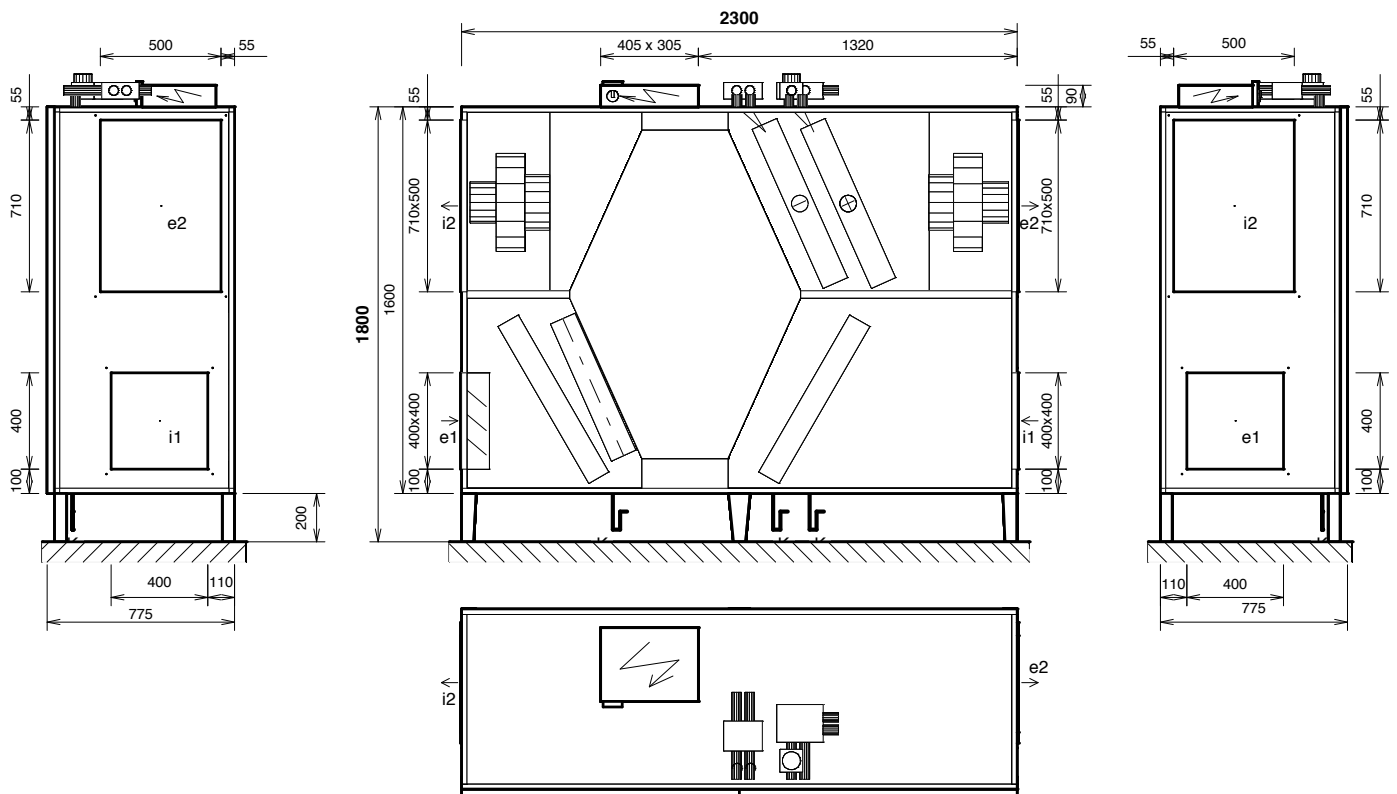

Connections	Type	Dimensions	Optional components
e1	e1- outdoor air (ODA)	400x400mm	Shutoff damper, Flexible connection
e2	e2- supply air (SUP)	710x500mm	Flexible connection
i1	i1- extract air (ETA)	400x400mm	Shutoff damper, Flexible connection
i2	i2- exhaust air (EHA)	710x500mm	Flexible connection
K	condensate drain	3x Ø 32 mm/40 mm	Condensate pump

Notice:

- Unit supplied as one piece
- Door - 2 parts
- Diagram is intended only for basic information, binding dimensions receive at device delivery, or on request from the manufacturer.
- Bolt holes for duct connection (for one port): 4 x M6

Duplexvent Multi eco DV4500

Commercial MVHR with cross-counter-flow heat exchanger - Indoor



KEY FEATURES

- Air volume up to 4000 m³/h at 200 Pa according to ErP 2018
- Digital Touchscreen or simple manual controller
- Low noise, refer to NR35 and BB93 standards
- Excellent thermal insulation (class T2, TB1)
- Filters: ePM2,5 65 % (F7), ePM10 70 % (M5) or Coarse 60 % (G4)
- Optional circulation damper
- Optional constant flow and constant pressure mode
- BREEAM and ErP 2018 compliant
- Meets Building Regulations Part L2A and L2B

PERFORMANCE

Ventilation		Supply Air	Extract Air
Air volume @ 200 Pa	m ³ /h / l/s	4000 / 1111	4000 / 1111
Nominal voltage	V	400	400
Nominal power (at operation point)	kW	1.01	0.93
Fan Speed	min ⁻¹	2182	2130
Max power input	kW	2.5	2.5
Max current	A	3.8	3.8
Fan Type		EC	EC

Note: The figures above have been measured at 4000 m³/h and 200 Pa. Please use the Duplexvent Selection Software to calculate measurements at other performance levels.

AIR FLOW CURVE

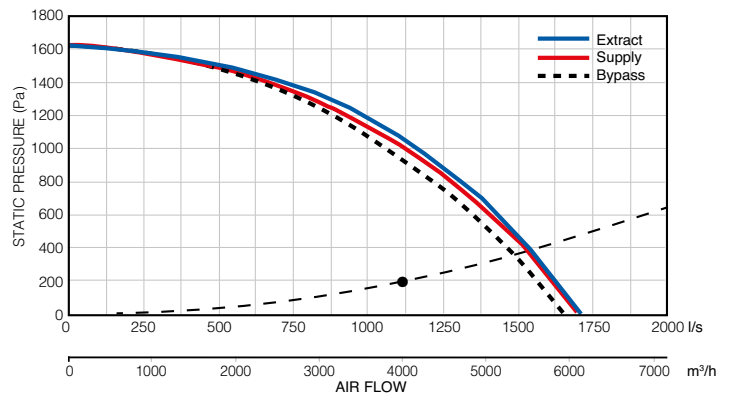

Heat Recovery		Supply Air	Extract Air
Air volume @ 200 Pa	m ³ /h / l/s	4000 / 1111	4000 / 1111
Temperature at inlet	°C	-5	20
Temperature at outlet	°C	17.4	2.5
Humidity at inlet	% RH	90	40
Humidity at outlet	% RH	18	96
Heat recovery efficiency winter / summer	%	87 / 83	
Performance in winter / summer	kW	30.3 / 6.9	
Condensation	l/h	7.2	
Type of heat exchanger		Cross-counter-flow, Plastic	
Part No.		90000796	

Note: The figures above have been measured at 4000 m³/h and 200 Pa. Please use the Duplexvent Selection Software to calculate measurements at other performance levels.

POWER CONSUMPTION

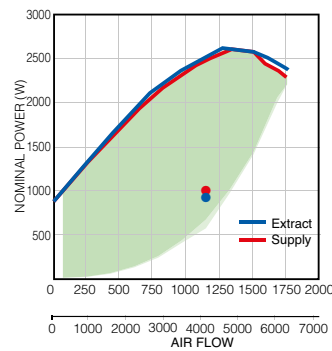

Note: Green area denotes power consumption range. Power consumption depends on system installation.

HEAT RECOVERY EFFICIENCY

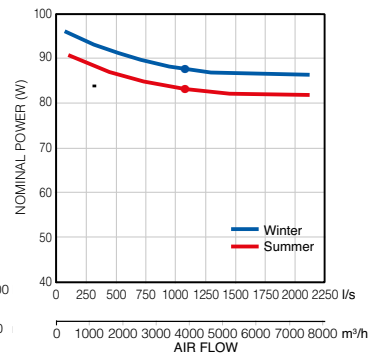

Sound Power Level L _w	Total	63 Hz	125 Hz	250 Hz	500 Hz	1 kHz	2 kHz	4 kHz	8 kHz
	dB (A)								
Outdoor air e1	65	46	52	62	60	56	46	44	31
Supply air e2	89	64	71	80	86	84	77	70	60
Extract air i1	64	43	50	57	63	50	40	30	<25
Exhaust air i2	89	64	71	79	86	84	76	69	62
Breakout noise	75	44	52	73	70	66	62	57	47
Sound Pressure Level L _p measured at 3m	55	<25	31	52	49	45	42	36	27

Note: The figures above have been measured at 4000 m³/h and 200 Pa. Please use the Duplexvent Selection Software to calculate measurements at other performance levels.

Winter Operation:

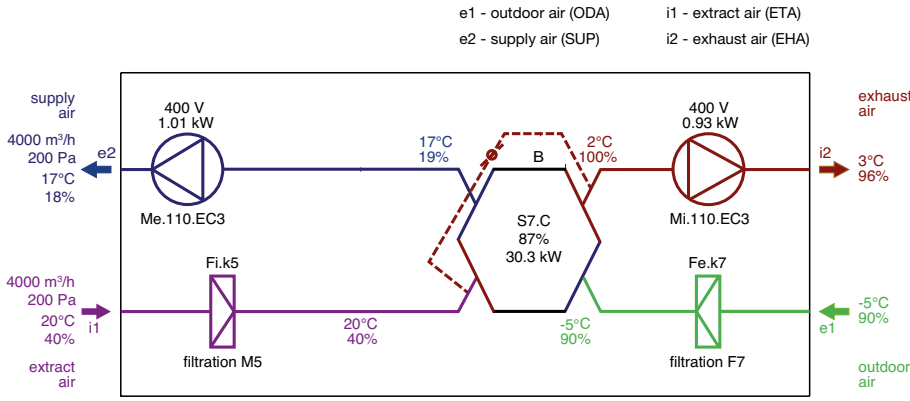

Note: AHU functions diagram. Inlet and outlet location may differ from actual position and port configuration.

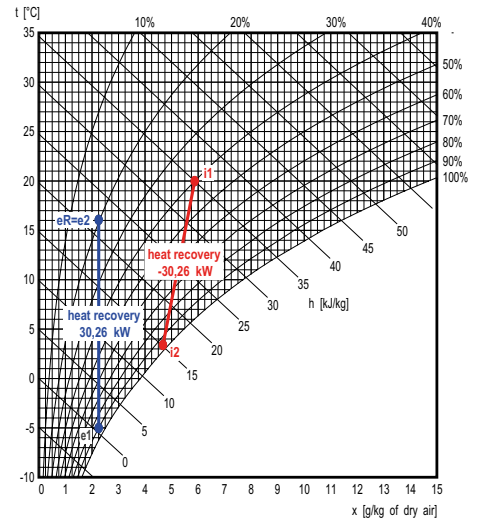

Supply

Description	t [°C]	RH [%]
e1 Outdoor Air	-5.0	90
e2 Supply Air	17.4	18

Exhaust

Description	t [°C]	RH [%]
i1 Extract Air	20.0	40
i2 Exhaust Air	2.5	96

Summer Operation:

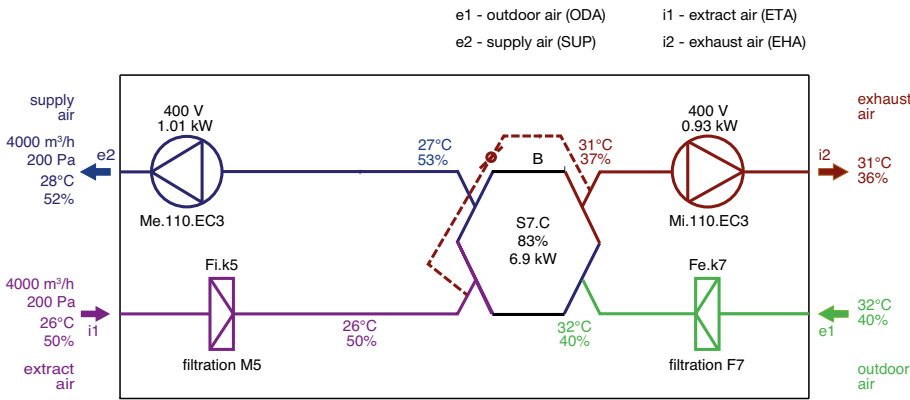

Note: AHU functions diagram. Inlet and outlet location may differ from actual position and port configuration.

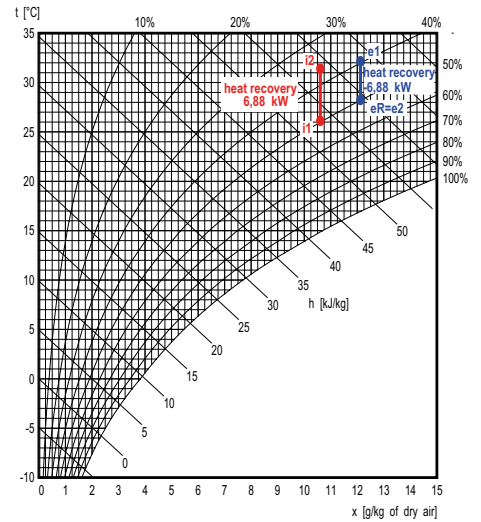

Supply

Description	t [°C]	RH [%]
e1 Outdoor Air	32.0	40
e2 Supply Air	27.7	52

Exhaust

Description	t [°C]	RH [%]
i1 Extract Air	26.0	50
i2 Exhaust Air	31.5	36

FILTERS

Filtration Type	Supply	Extract	Accessories (part of delivery)
	Pleated Cartridge		
Filtration class	ePM2,5 65 % (F7)	ePM10 70 % (M5)	Pfe dirty filter pressure switch for supply air
Number of filters	2	2	Pfi dirty filter pressure switch for extract air
Filter cartridge size	750x405x96	750x405x96	

Duplexvent Multi eco DV4500

Commercial MVHR with cross-counter-flow heat exchanger - Indoor

OPTIONAL ACCESSORIES

ELECTRIC PRE-HEATER

Electric pre-heater		Supply
Air volume	m ³ /h / l/s	4000 / 1111
Maximum heating capacity	kW	15.0
Voltage	V	400
Connection ports	mm	300x300

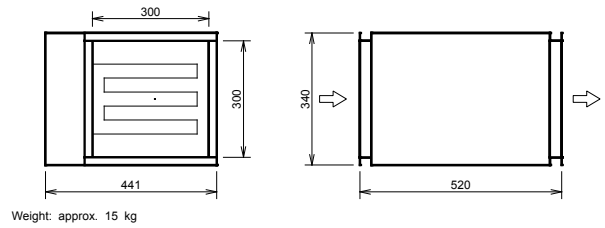

WATER HEATING COIL

Water heating coil		Supply
Heating medium		Water
Air volume	m ³ /h / l/s	4000 / 1111
Temperature at inlet (after heat recovery)	°C	17
Temperature at outlet (downstream of the heater)	°C	19
Heating capacity	kW	3.2
Heating medium temperature drop	°C	70/50
Medium flow (from source)	l/h	139
Connection dimension (hydraulic kit)		1" female

Note: The figures above have been measured at 4000 m³/h and 200 Pa. Please use the Duplexvent Selection Software to calculate measurements at other performance levels.

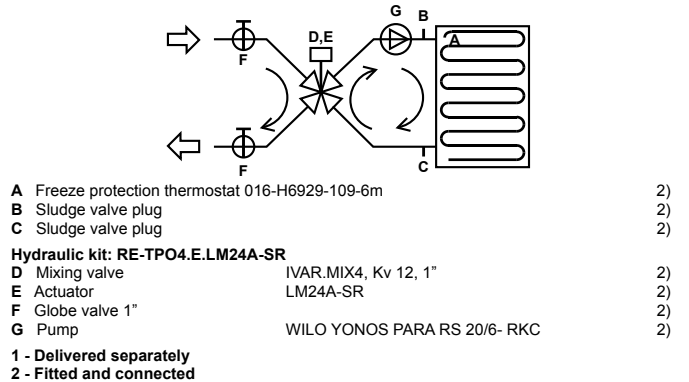

HEATING CAPACITY

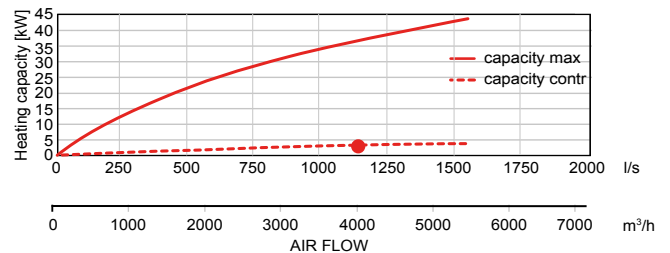

WATER COOLING COIL

Water cooling coil		Supply
Cooling medium		21% Ethylene glycol
Air volume	m ³ /h / l/s	4000 / 1111
Temperature at inlet (after heat recovery)	°C	27
Temperature at outlet (downstream of the cooling coil)	°C	16
Inlet relative humidity (after heat recovery)	% RH	53
Outlet relative humidity (downstream of the cooling coil)	% RH	86
Cooling capacity	kW	21.9
Condensate production	l/h	11
Water temperature drop	°C	6 / 12
Medium flow (at max. capacity)	l/h	3730
Medium-side pressure drop		
in heat exchanger	kPa	26.07
in valve	kPa	13.59
Connection dimension		1" female

Note: The figures above have been measured at 4000 m³/h and 200 Pa. Please use the Duplexvent Selection Software to calculate measurements at other performance levels.

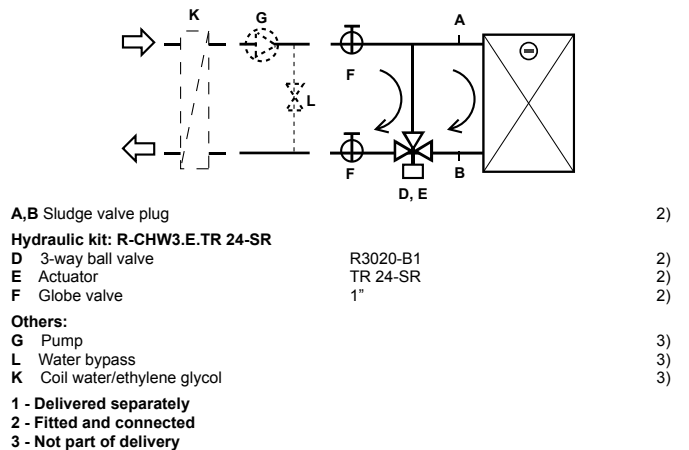

COOLING CAPACITY

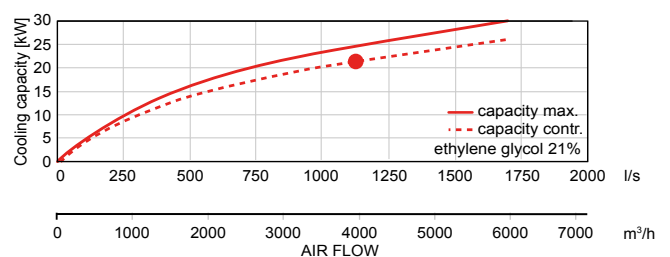

DX COIL

DX coil		Supply
Air volume	m ³ /h / l/s	4000 / 1111
Temperature at inlet (after heat recovery)	°C	27
Temperature at outlet (downstream of the DX coil)	°C	16
Inlet relative humidity (after heat recovery)	% RH	53
Outlet relative humidity (downstream of the DX coil)	% RH	80
Cooling capacity	kW	18.9
Condensate production	l/h	13
Refrigerant type		R410A
Evaporating temperature	°C	10

Note: The figures above have been measured at 4000 m³/h and 200 Pa. Please use the Duplexvent Selection Software to calculate measurements at other performance levels.

COOLING CAPACITY

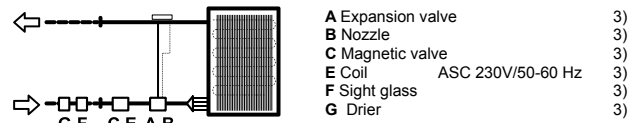
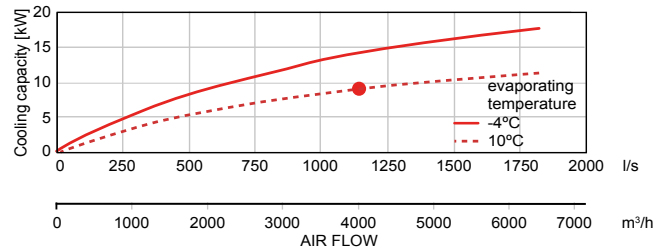

3 Not part of delivery, recommended type mentioned

DIMENSIONS

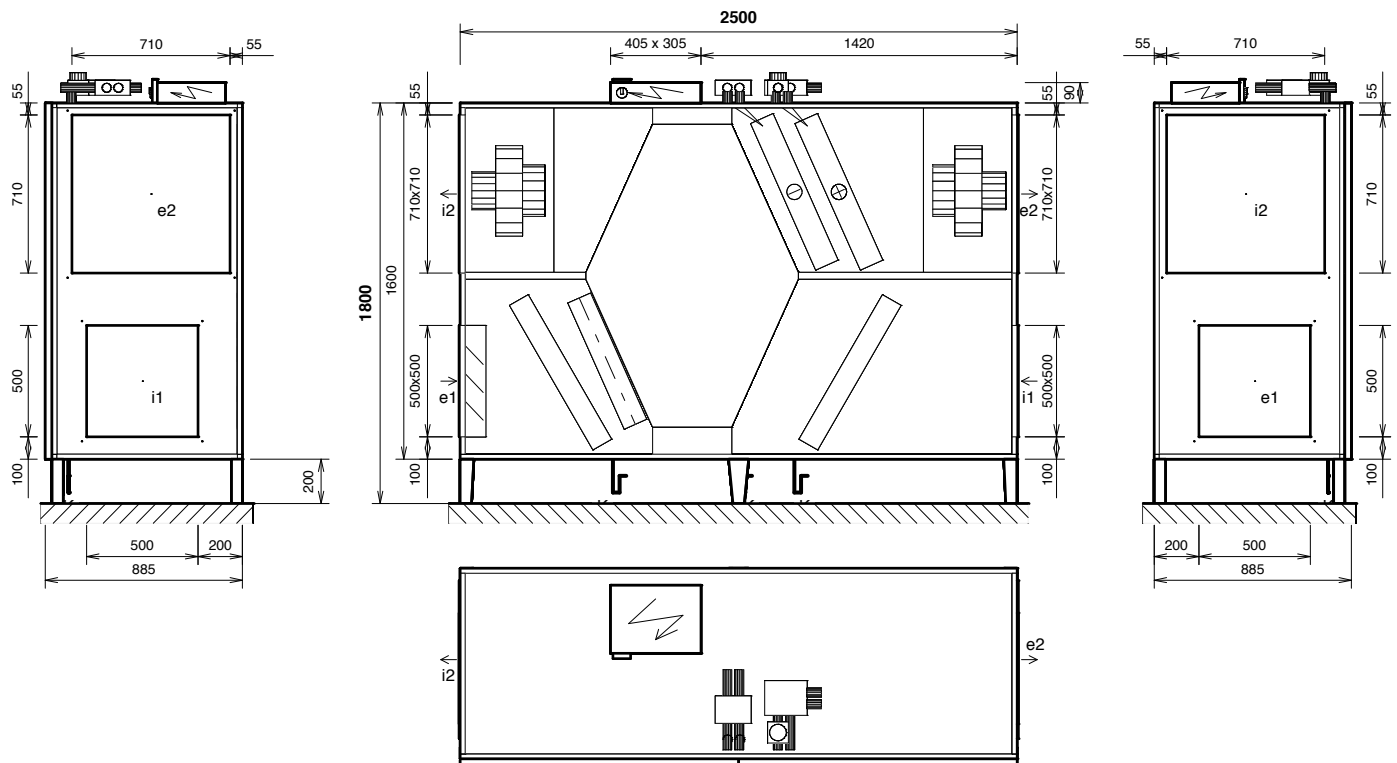

Connections	Type	Dimensions	Optional components
e1	e1- outdoor air (ODA)	500x500mm	Shutoff damper, Flexible connection
e2	e2- supply air (SUP)	710x710mm	Flexible connection
i1	i1- extract air (ETA)	500x500mm	Shutoff damper, Flexible connection
i2	i2- exhaust air (EHA)	710x710mm	Flexible connection
K	condensate drain	3x Ø 32 mm/40 mm	Condensate pump

Notice:

- Unit supplied as one piece
- Door - 2 parts
- Diagram is intended only for basic information, binding dimensions receive at device delivery, or on request from the manufacturer.
- Bolt holes for duct connection (for one port): 4 x M6

Duplexvent Multi eco DV5500

Commercial MVHR with cross-counter-flow heat exchanger - Indoor



KEY FEATURES

- Air volume up to 4900 m³/h at 200 Pa according to ErP 2018
- Digital Touchscreen or simple manual controller
- Low noise, refer to NR35 and BB93 standards
- Excellent thermal insulation (class T2, TB1)
- Filters: ePM2,5 65 % (F7), ePM10 70 % (M5) or Coarse 60 % (G4)
- Optional circulation damper
- Optional constant flow and constant pressure mode
- BREEAM and ErP 2018 compliant
- Meets Building Regulations Part L2A and L2B

PERFORMANCE

Ventilation		Supply Air	Extract Air
Air volume @ 200 Pa	m ³ /h / l/s	4900 / 1361	4900 / 1361
Nominal voltage	V	400	400
Nominal power (at operation point)	kW	1.2	1.2
Fan Speed	min ⁻¹	1977	1950
Max power input	kW	3.3	3.3
Max current	A	5.4	5.4
Fan Type		EC	EC

Note: The figures above have been measured at 4900 m³/h and 200 Pa. Please use the Duplexvent Selection Software to calculate measurements at other performance levels.

AIR FLOW CURVE

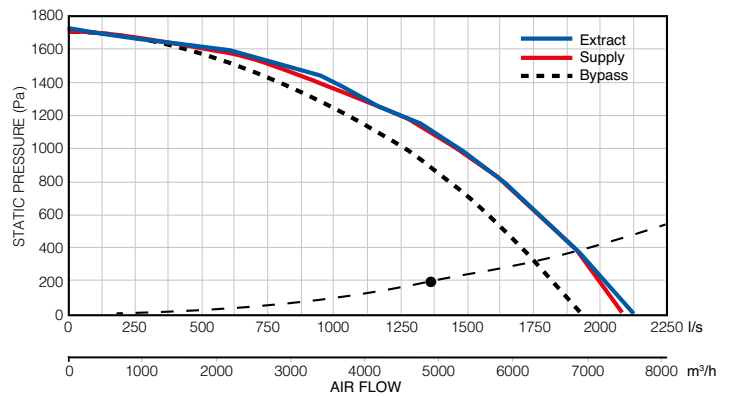

Heat Recovery		Supply Air	Extract Air
Air volume @ 200 Pa	m ³ /h / l/s	4900 / 1361	4900 / 1361
Temperature at inlet	°C	-5	20
Temperature at outlet	°C	17.2	2.6
Humidity at inlet	% RH	90	40
Humidity at outlet	% RH	18	96
Heat recovery efficiency winter / summer	%	87 / 82	
Performance in winter / summer	kW	36.8 / 8.4	
Condensation	l/h	8.6	
Type of heat exchanger		Cross-counter-flow, Plastic	
Part No.		90000797	

Note: The figures above have been measured at 4900 m³/h and 200 Pa. Please use the Duplexvent Selection Software to calculate measurements at other performance levels.

POWER CONSUMPTION

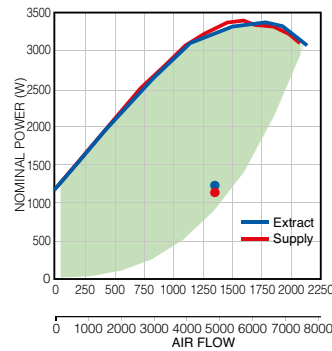

Note: Green area denotes power consumption range. Power consumption depends on system installation.

HEAT RECOVERY EFFICIENCY

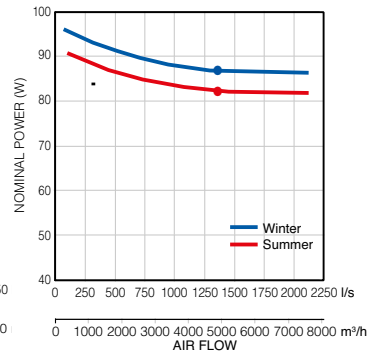

Sound Power Level L _w	Total	63 Hz	125 Hz	250 Hz	500 Hz	1 kHz	2 kHz	4 kHz	8 kHz
	dB (A)								
Outdoor air e1	67	49	54	64	62	56	46	40	34
Supply air e2	93	73	79	84	90	87	79	72	62
Extract air i1	66	42	51	61	64	52	40	27	<25
Exhaust air i2	92	71	78	85	89	85	77	70	60
Breakout noise	66	43	46	64	59	57	49	45	33
Sound Pressure Level L _p measured at 3m	46	<25	26	44	38	37	28	25	<25

Note: The figures above have been measured at 4900 m³/h and 200 Pa. Please use the Duplexvent Selection Software to calculate measurements at other performance levels.

Winter Operation:

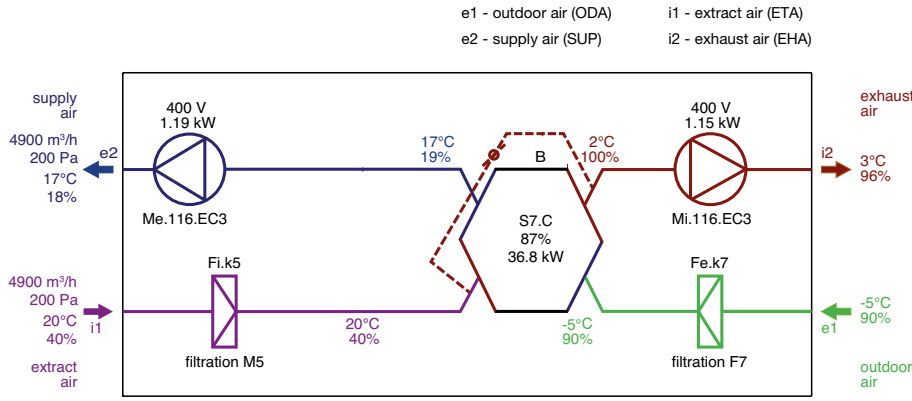

Note: AHU functions diagram. Inlet and outlet location may differ from actual position and port configuration.

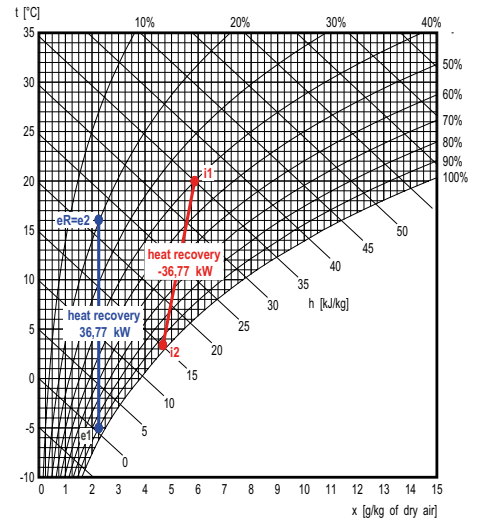

Supply

	Description	t [°C]	RH [%]
e1	Outdoor Air	-5.0	90
e2	Supply Air	17.2	18

Exhaust

	Description	t [°C]	RH [%]
i1	Extract Air	20.0	40
i2	Exhaust Air	2.6	96

Summer Operation:

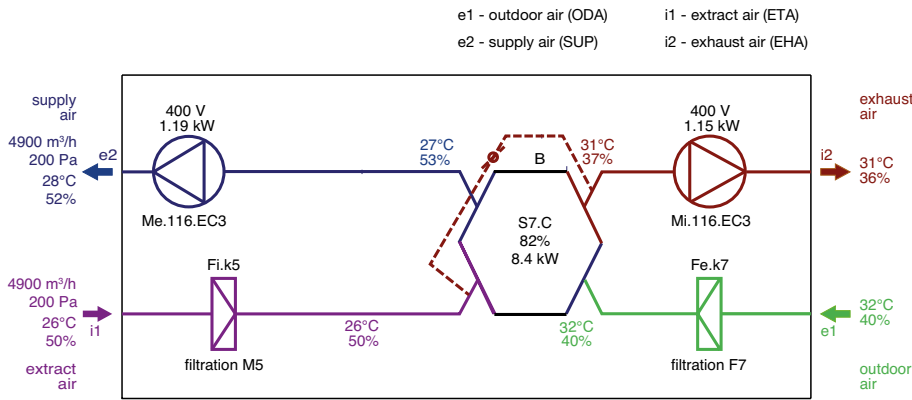

Note: AHU functions diagram. Inlet and outlet location may differ from actual position and port configuration.

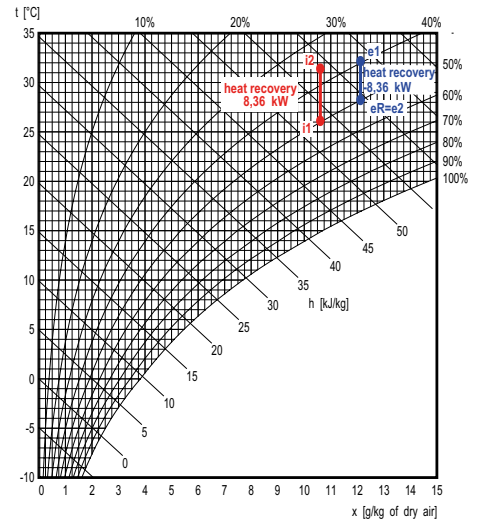

Supply

	Description	t [°C]	RH [%]
e1	Outdoor Air	32.0	40
e2	Supply Air	27.7	52

Exhaust

	Description	t [°C]	RH [%]
i1	Extract Air	26.0	50
i2	Exhaust Air	31.4	36

FILTERS

Filtration	Supply	Extract	Accessories (part of delivery)
Type	Pleated Cartridge		Pfe dirty filter pressure switch for supply air Pfi dirty filter pressure switch for extract air
Filtration class	ePM2,5 65 % (F7)	ePM10 70 % (M5)	
Number of filters	2	2	
Filter cartridge size	750x405x96	750x405x96	

Duplexvent Multi eco DV5500

Commercial MVHR with cross-counter-flow heat exchanger - Indoor

OPTIONAL ACCESSORIES

ELECTRIC PRE-HEATER

Electric pre-heater		Supply
Air volume	m ³ /h / l/s	4900 / 1361
Maximum heating capacity	kW	24.0
Voltage	V	400
Connection ports	mm	500x300

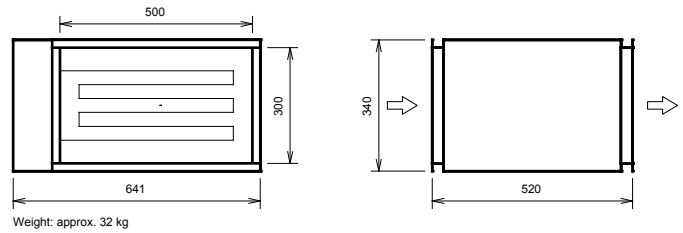

WATER HEATING COIL

Water heating coil		Supply
Heating medium		Water
Air volume	m ³ /h / l/s	4900 / 1361
Temperature at inlet (after heat recovery)	°C	17
Temperature at outlet (downstream of the heater)	°C	19
Heating capacity	kW	4.4
Heating medium temperature drop	°C	70/50
Medium flow (from source)	l/h	189
Connection dimension (hydraulic kit)		1" female

Note: The figures above have been measured at 4900 m³/h and 200 Pa. Please use the Duplexvent Selection Software to calculate measurements at other performance levels.

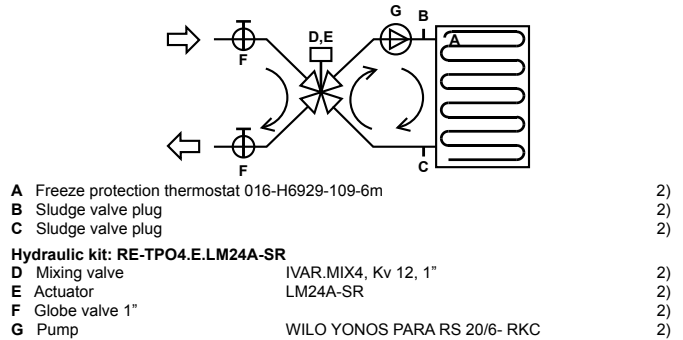

- A Freeze protection thermostat 016-H6929-109-6m 2)
- B Sludge valve plug 2)
- C Sludge valve plug 2)
- Hydraulic kit: RE-TPO4.E.LM24A-SR
- D Mixing valve IVAR.MIX4, Kv 12, 1" 2)
- E Actuator LM24A-SR 2)
- F Globe valve 1" 2)
- G Pump WILO YONOS PARA RS 20/6- RKC 2)

1 - Delivered separately
2 - Fitted and connected

HEATING CAPACITY

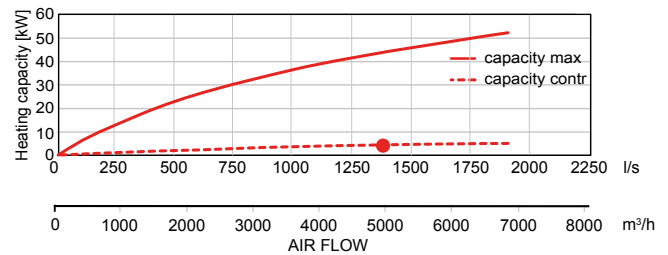

WATER COOLING COIL

Water cooling coil		Supply
Cooling medium		21% Ethylene glycol
Air volume	m ³ /h / l/s	4900 / 1361
Temperature at inlet (after heat recovery)	°C	27
Temperature at outlet (downstream of the cooling coil)	°C	16
Inlet relative humidity (after heat recovery)	% RH	53
Outlet relative humidity (downstream of the cooling coil)	% RH	87
Cooling capacity	kW	26.1
Condensate production	l/h	12
Water temperature drop	°C	6 / 12
Medium flow (at max. capacity)	l/h	4370
Medium-side pressure drop		
in heat exchanger	kPa	19.25
in valve	kPa	18.65
Connection dimension		1" female

Note: The figures above have been measured at 4900 m³/h and 200 Pa. Please use the Duplexvent Selection Software to calculate measurements at other performance levels.

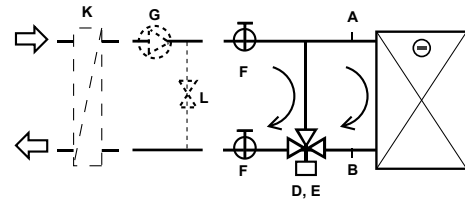

- A, B Sludge valve plug 2)
- Hydraulic kit: R-CHW3.E.TR 24-SR
- D 3-way ball valve R3020-B1 2)
- E Actuator TR 24-SR 2)
- F Globe valve 1" 2)
- Others:
- G Pump 3)
- L Water bypass 3)
- K Coil water/ethylene glycol 3)

1 - Delivered separately
2 - Fitted and connected
3 - Not part of delivery

COOLING CAPACITY

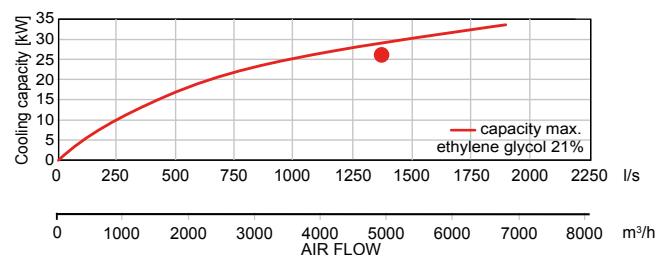

DX COIL

DX coil		Supply
Air volume	m ³ /h / l/s	4900 / 1361
Temperature at inlet (after heat recovery)	°C	27
Temperature at outlet (downstream of the DX coil)	°C	16
Inlet relative humidity (after heat recovery)	% RH	53
Outlet relative humidity (downstream of the DX coil)	% RH	82
Cooling capacity	kW	23.5
Condensate production	l/h	15
Refrigerant type		R410A
Evaporating temperature	°C	9

Note: The figures above have been measured at 4900 m³/h and 200 Pa. Please use the Duplexvent Selection Software to calculate measurements at other performance levels.

COOLING CAPACITY

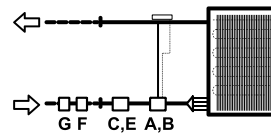
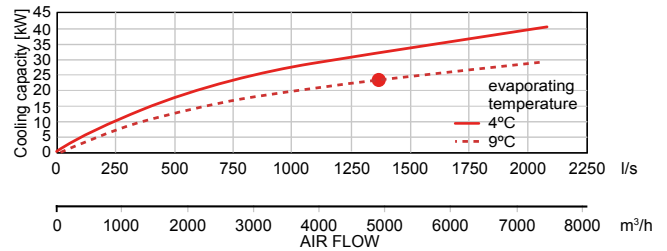

- A Expansion valve (3)
- B Nozzle (3)
- C Magnetic valve (3)
- E Coil ASC 230V/50-60 Hz (3)
- F Sight glass (3)
- G Drier (3)

3 Not part of delivery, recommended type mentioned

DIMENSIONS

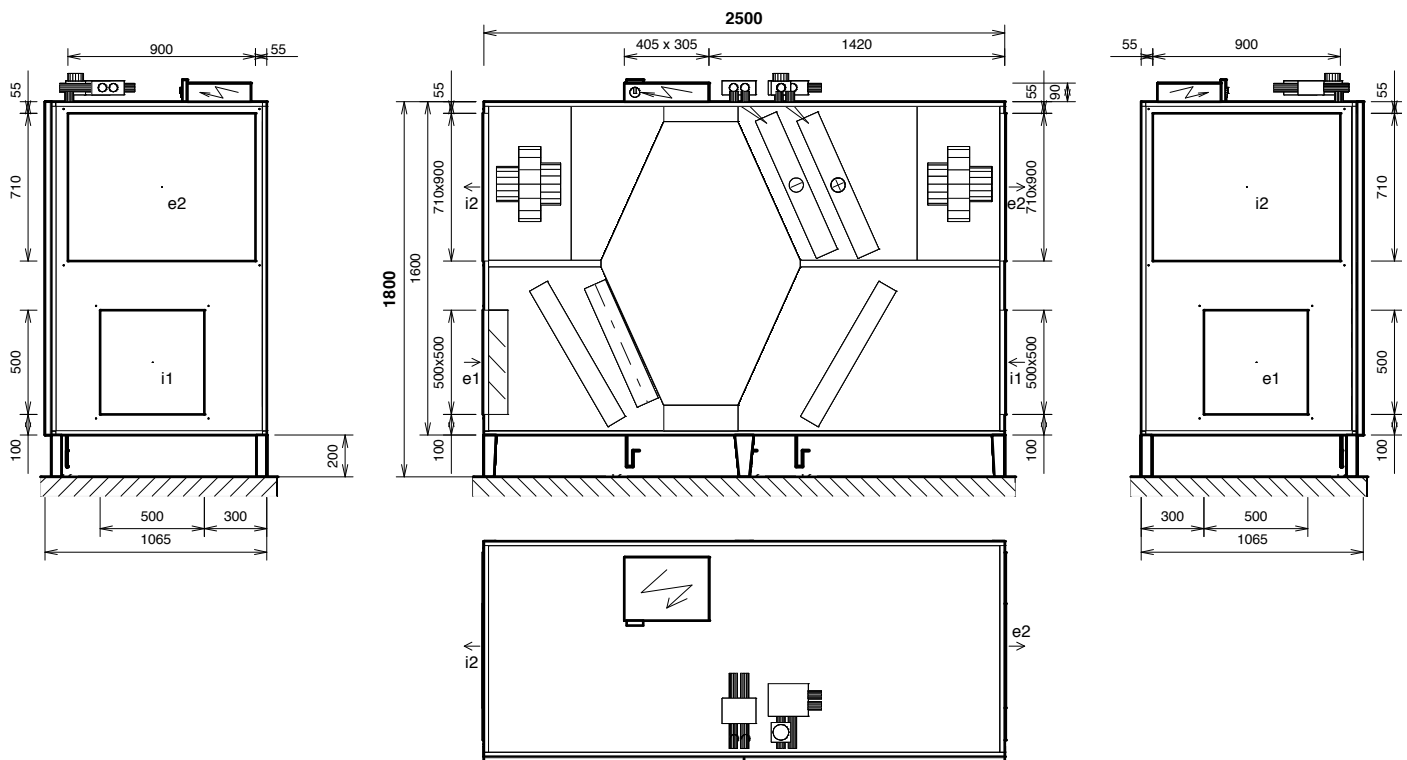

Connections	Type	Dimensions	Optional components
e1	e1- outdoor air (ODA)	500x500mm	Shutoff damper, Flexible connection
e2	e2- supply air (SUP)	710x900mm	Flexible connection
i1	i1- extract air (ETA)	500x500mm	Shutoff damper, Flexible connection
i2	i2- exhaust air (EHA)	710x900mm	Flexible connection
K	condensate drain	3x Ø 32 mm/40 mm	Condensate pump

Notice:

- Unit supplied as one piece
- Door - 2 parts
- Diagram is intended only for basic information, binding dimensions receive at device delivery, or on request from the manufacturer.
- Bolt holes for duct connection (for one port): 4 x M6

Duplexvent Multi eco DV6500

Commercial MVHR with cross-counter-flow heat exchanger - Indoor



KEY FEATURES

- Air volume up to 5500 m³/h at 200 Pa according to ErP 2018
- Digital Touchscreen or simple manual controller
- Low noise, refer to NR35 and BB93 standards
- Excellent thermal insulation (class T2, TB1)
- Filters: ePM2,5 65 % (F7), ePM10 70 % (M5) or Coarse 60 % (G4)
- Optional circulation damper
- Optional constant flow and constant pressure mode
- BREEAM and ErP 2018 compliant
- Meets Building Regulations Part L2A and L2B

PERFORMANCE

Ventilation		Supply Air	Extract Air
Air volume @ 200 Pa	m ³ /h / l/s	5500 / 1528	5500 / 1528
Nominal voltage	V	400	400
Nominal power (at operation point)	kW	1.3	1.3
Fan Speed	min ⁻¹	2043	2017
Max power input	kW	3.3	3.3
Max current	A	5.4	5.4
Fan Type		EC	EC

Note: The figures above have been measured at 5500 m³/h and 200 Pa. Please use the Duplexvent Selection Software to calculate measurements at other performance levels.

AIR FLOW CURVE

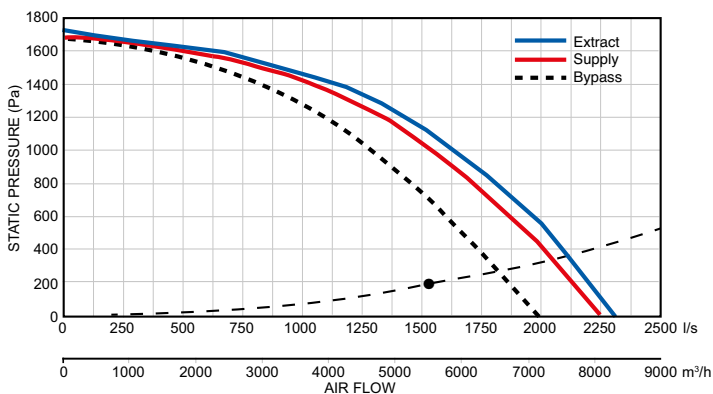

Heat Recovery		Supply Air	Extract Air
Air volume @ 200 Pa	m ³ /h / l/s	5500 / 1528	5500 / 1528
Temperature at inlet	°C	-5	20
Temperature at outlet	°C	17.3	2.6
Humidity at inlet	% RH	90	40
Humidity at outlet	% RH	18	97
Heat recovery efficiency winter / summer	%	87 / 82	
Performance in winter / summer	kW	41.4 / 9.4	
Condensation	l/h	9.7	
Type of heat exchanger		Cross-counter-flow, Plastic	
Part No.		90000798	

Note: The figures above have been measured at 5500 m³/h and 200 Pa. Please use the Duplexvent Selection Software to calculate measurements at other performance levels.

POWER CONSUMPTION

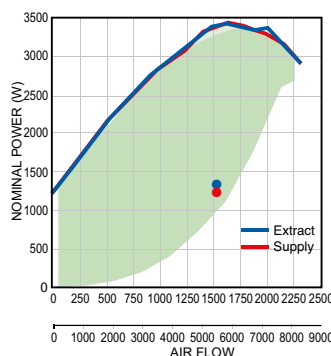

Note: Green area denotes power consumption range. Power consumption depends on system installation.

HEAT RECOVERY EFFICIENCY

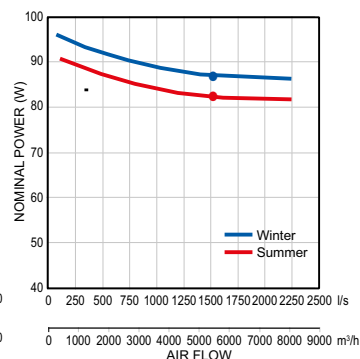

Sound Power Level L _w	Total	63 Hz	125 Hz	250 Hz	500 Hz	1 kHz	2 kHz	4 kHz	8 kHz
	dB (A)								
Outdoor air e1	69	49	56	64	65	60	48	40	31
Supply air e2	91	69	75	81	88	87	80	72	62
Extract air i1	69	47	56	63	67	58	46	30	<25
Exhaust air i2	86	59	65	76	82	81	74	67	62
Breakout noise	74	51	57	70	69	66	66	62	50
Sound Pressure Level L _p measured at 3m	54	30	36	49	48	46	46	41	30

Note: The figures above have been measured at 5500 m³/h and 200 Pa. Please use the Duplexvent Selection Software to calculate measurements at other performance levels.

Winter Operation:

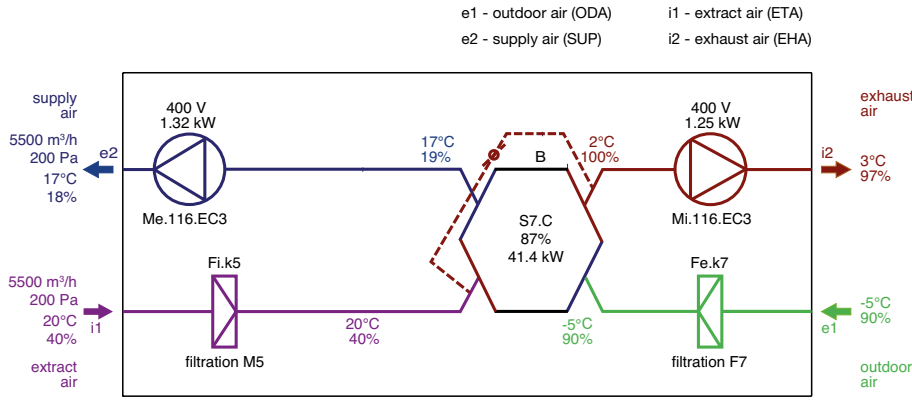

Note: AHU functions diagram. Inlet and outlet location may differ from actual position and port configuration.

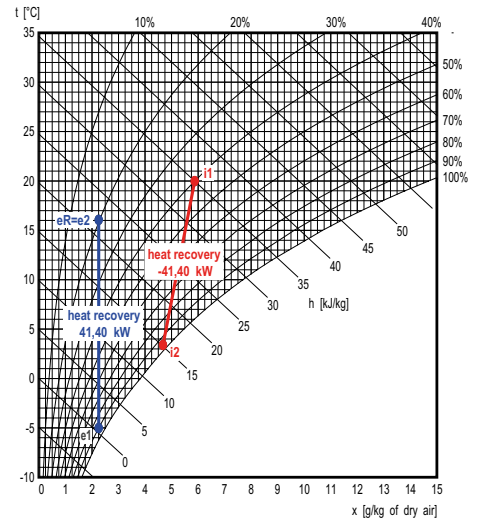

Supply

	Description	t [°C]	RH [%]
e1	Outdoor Air	-5.0	90
e2	Supply Air	17.3	18

Exhaust

	Description	t [°C]	RH [%]
i1	Extract Air	20.0	40
i2	Exhaust Air	2.6	97

Summer Operation:

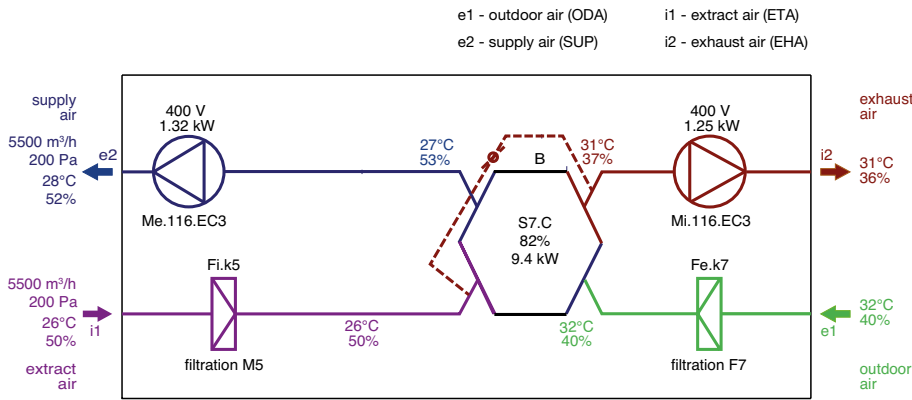

Note: AHU functions diagram. Inlet and outlet location may differ from actual position and port configuration.

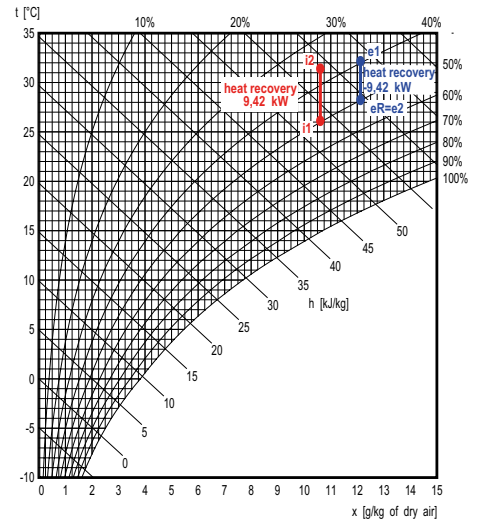

Supply

	Description	t [°C]	RH [%]
e1	Outdoor Air	32.0	40
e2	Supply Air	27.7	52

Exhaust

	Description	t [°C]	RH [%]
i1	Extract Air	26.0	50
i2	Exhaust Air	31.4	36

FILTERS

Filtration	Supply	Extract	Accessories (part of delivery)
Type	Pleated Cartridge		Pfe dirty filter pressure switch for supply air Pfi dirty filter pressure switch for extract air
Filtration class	ePM2,5 65 % (F7)	ePM10 70 % (M5)	
Number of filters	3	3	
Filter cartridge size	750x405x96	750x405x96	

Duplexvent Multi eco DV6500

Commercial MVHR with cross-counter-flow heat exchanger - Indoor

OPTIONAL ACCESSORIES

ELECTRIC PRE-HEATER

Electric pre-heater		Supply
Air volume	m ³ /h / l/s	5500 / 1528
Maximum heating capacity	kW	54.0
Voltage	V	400
Connection ports	mm	800x500

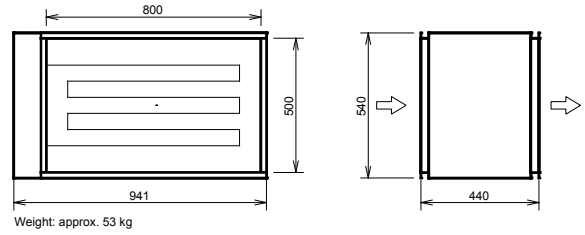

WATER HEATING COIL

Water heating coil		Supply
Heating medium		Water
Air volume	m ³ /h / l/s	5500 / 1528
Temperature at inlet (after heat recovery)	°C	17
Temperature at outlet (downstream of the heater)	°C	19
Heating capacity	kW	5
Heating medium temperature drop	°C	70/50
Medium flow (from source)	l/h	215
Connection dimension (hydraulic kit)		1" female

Note: The figures above have been measured at 5500 m³/h and 200 Pa. Please use the Duplexvent Selection Software to calculate measurements at other performance levels.

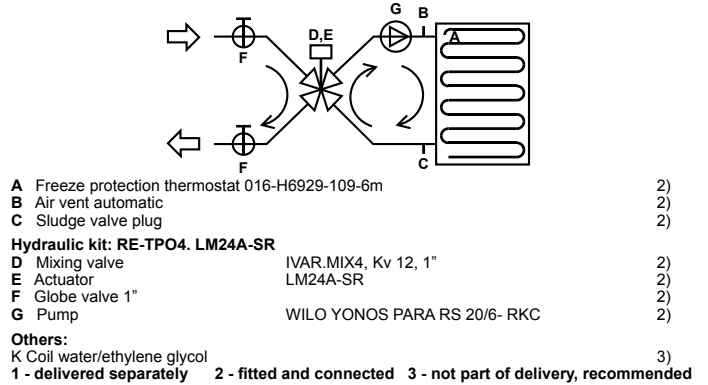

HEATING CAPACITY

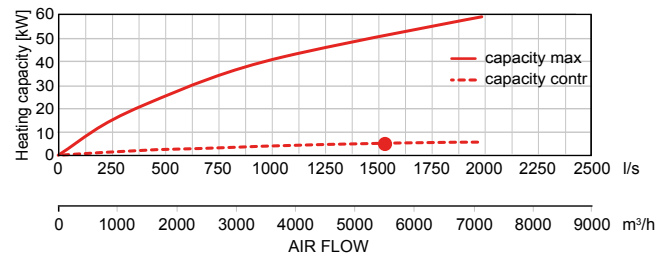

WATER COOLING COIL

Water cooling coil		Supply
Cooling medium		21% Ethylene glycol
Air volume	m ³ /h / l/s	5500 / 1528
Temperature at inlet (after heat recovery)	°C	27
Temperature at outlet (downstream of the cooling coil)	°C	17
Inlet relative humidity (after heat recovery)	% RH	53
Outlet relative humidity (downstream of the cooling coil)	% RH	95
Cooling capacity	kW	21.6
Condensate production	l/h	4
Water temperature drop	°C	6 / 12
Medium flow (at max. capacity)	l/h	3260
Medium-side pressure drop		
in heat exchanger	kPa	3.46
in valve	kPa	10.4
Connection dimension		1" female

Note: The figures above have been measured at 5500 m³/h and 200 Pa. Please use the Duplexvent Selection Software to calculate measurements at other performance levels.

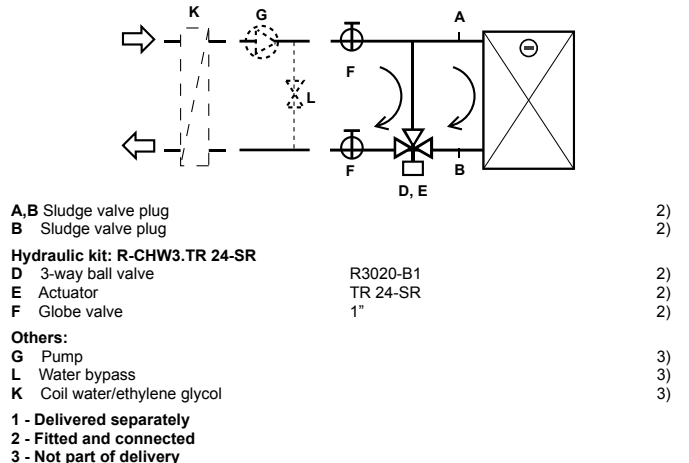

COOLING CAPACITY

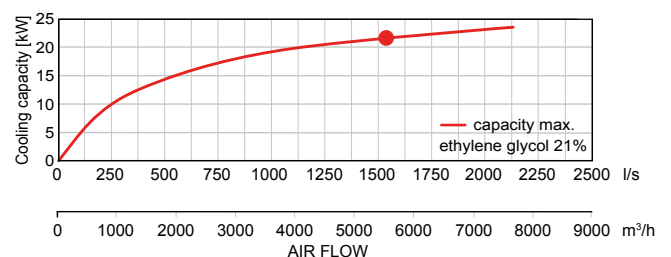

DX COIL

DX coil		Supply
Air volume	m ³ /h / l/s	5500 / 1528
Temperature at inlet (after heat recovery)	°C	27
Temperature at outlet (downstream of the DX coil)	°C	17
Inlet relative humidity (after heat recovery)	% RH	53
Outlet relative humidity (downstream of the DX coil)	% RH	78
Cooling capacity	kW	23.6
Condensate production	l/h	18
Refrigerant type		R410A
Evaporating temperature	°C	11

Note: The figures above have been measured at 5500 m³/h and 200 Pa. Please use the Duplexvent Selection Software to calculate measurements at other performance levels.

COOLING CAPACITY

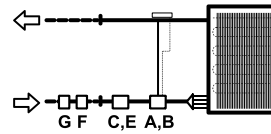
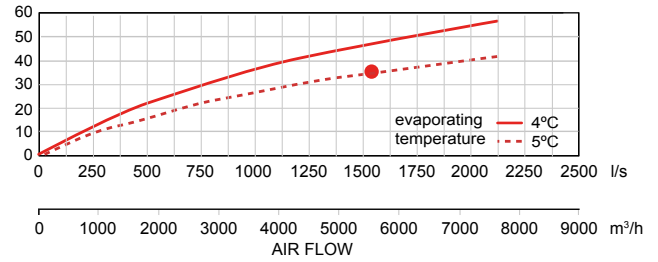

- A Expansion valve (3)
- B Nozzle (3)
- C Magnetic valve (3)
- E Coil ASC 230V/50-60 Hz (3)
- F Sight glass (3)
- G Drier (3)

3 Not part of delivery, recommended type mentioned

DIMENSIONS

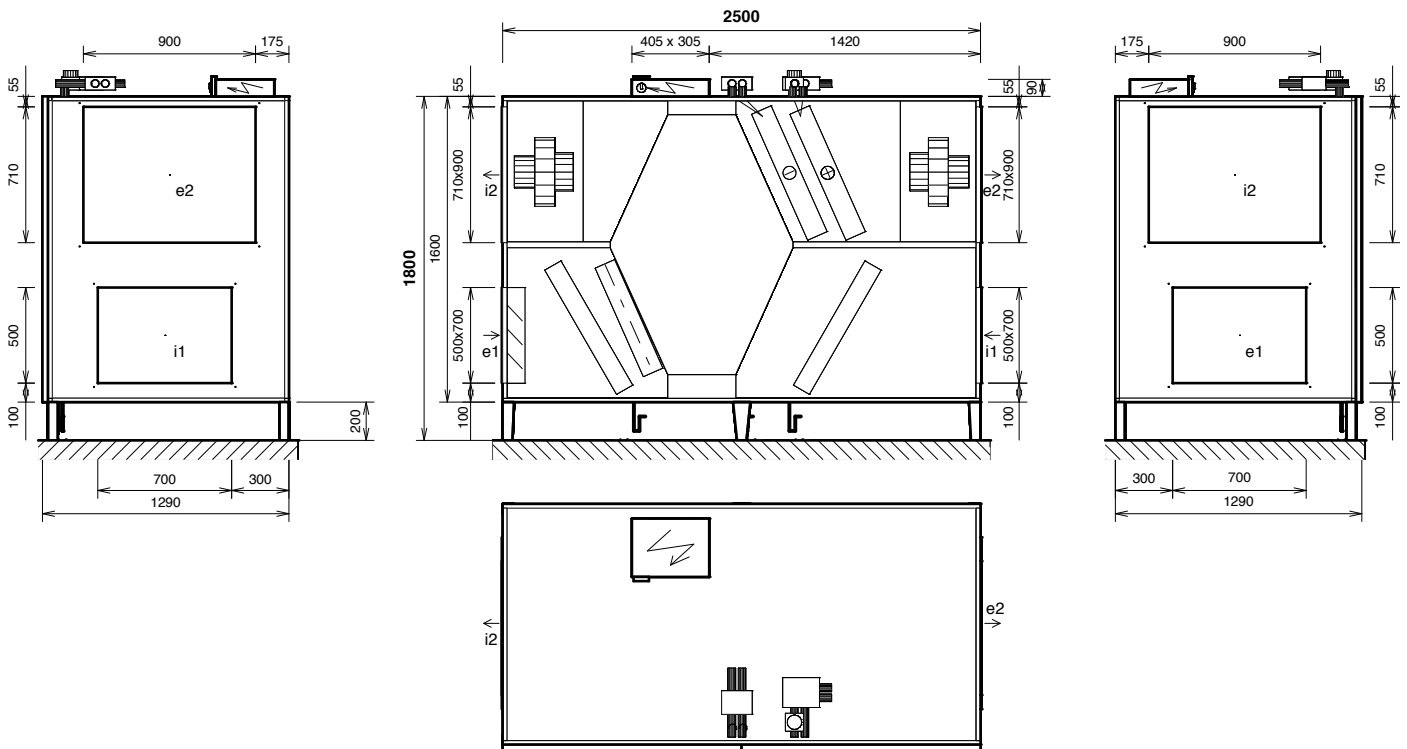

Connections	Type	Dimensions	Optional components
e1	e1- outdoor air (ODA)	500x700mm	Shutoff damper, Flexible connection
e2	e2- supply air (SUP)	710x900mm	Flexible connection
i1	i1- extract air (ETA)	500x700mm	Shutoff damper, Flexible connection
i2	i2- exhaust air (EHA)	710x900mm	Flexible connection
K	condensate drain	3x Ø 32 mm/40 mm	Condensate pump

Notice:

- Terminal Strip places inside a unit
- Diagram is intended only for basic information, binding dimensions receive at device delivery, or on request from the manufacturer
- Bolt holes for duct connection (for one port): 4x M6
- incl: base frame heights 500mm
 - Duct extension e2
 - Duct extensions i1

Duplexvent Multi eco DV7500

Commercial MVHR with cross-counter-flow heat exchanger - Indoor



PERFORMANCE

Ventilation		Supply Air	Extract Air
Air volume @ 300 Pa	m ³ /h / l/s	7000 / 1944	7000 / 1944
Nominal voltage	V	400	400
Nominal power (at operation point)	kW	2.2	2.2
Fan Speed	min ⁻¹	2411	2420
Max power input	kW	3.3	3.3
Max current	A	5.4	5.4
Fan Type		EC	EC

Note: The figures above have been measured at 7000 m³/h and 300 Pa. Please use the Duplexvent Selection Software to calculate measurements at other performance levels.

Heat Recovery		Supply Air	Extract Air
Air volume @ 300 Pa	m ³ /h / l/s	7000 / 1944	7000 / 1944
Temperature at inlet	°C	-5	20
Temperature at outlet	°C	17.5	2.7
Humidity at inlet	% RH	90	40
Humidity at outlet	% RH	18	95
Heat recovery efficiency winter / summer	%	87 / 83	
Performance in winter / summer	kW	52.7 / 12.0	
Condensation	l/h	12.4	
Type of heat exchanger		Cross-counter-flow, Plastic	
Part No.		90000799	

Note: The figures above have been measured at 7000 m³/h and 300 Pa. Please use the Duplexvent Selection Software to calculate measurements at other performance levels.

Sound Power Level L _w	Total	dB (A)							
		63 Hz	125 Hz	250 Hz	500 Hz	1 kHz	2 kHz	4 kHz	8 kHz
Outdoor air e1	64	52	49	55	60	59	50	49	39
Supply air e2	90	53	59	75	81	86	84	79	74
Extract air i1	68	45	39	63	64	61	53	40	29
Exhaust air i2	90	74	73	78	86	86	81	76	72
Breakout noise	71	46	54	71	58	53	47	44	45
Sound Pressure Level L _p measured at 3m	50	25	33	50	38	32	27	<25	<25

Note: The figures above have been measured at 7000 m³/h and 300 Pa. Please use the Duplexvent Selection Software to calculate measurements at other performance levels.

KEY FEATURES

- Air volume up to 7000 m³/h at 300 Pa according to ErP 2018
- Digital Touchscreen or simple manual controller
- Low noise, refer to NR35 and BB93 standards
- Excellent thermal insulation (class T2, TB1)
- Filters: ePM2,5 65 % (F7), ePM10 70 % (M5) or Coarse 60 % (G4)
- Optional circulation damper
- Optional constant flow and constant pressure mode
- BREEAM and ErP 2018 compliant
- Meets Building Regulations Part L2A and L2B

AIR FLOW CURVE

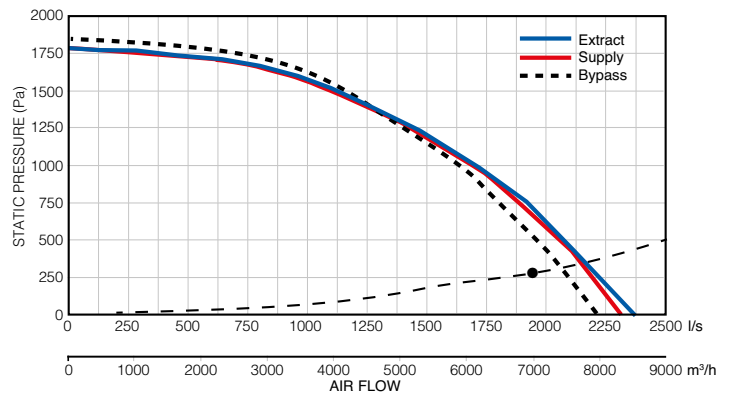

POWER CONSUMPTION

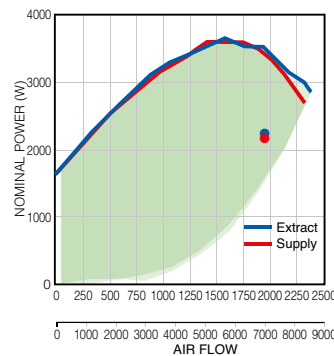

Note: Green area denotes power consumption range. Power consumption depends on system installation.

HEAT RECOVERY EFFICIENCY

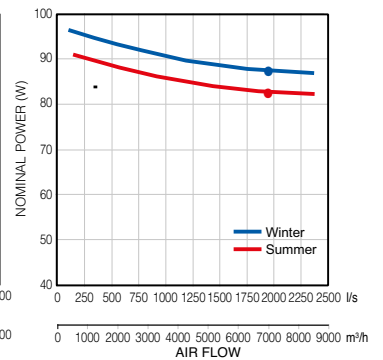

Winter Operation:

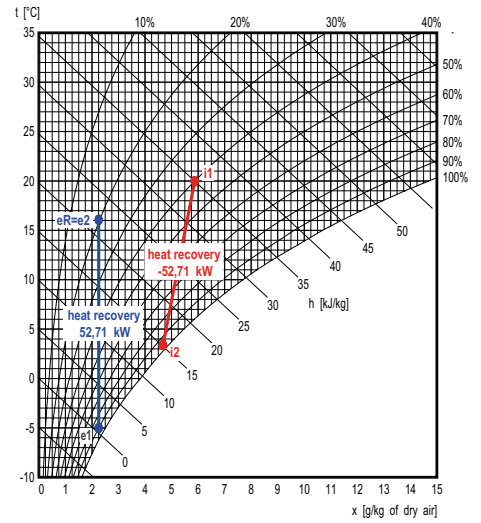
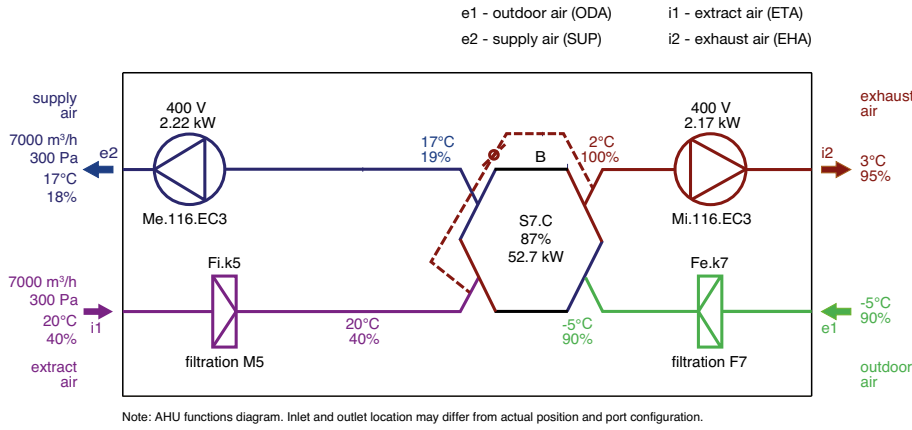

Supply

	Description	t [°C]	RH [%]
e1	Outdoor Air	-5.0	90
e2	Supply Air	17.5	18

Exhaust

	Description	t [°C]	RH [%]
i1	Extract Air	20.0	40
i2	Exhaust Air	2.7	95

Summer Operation:

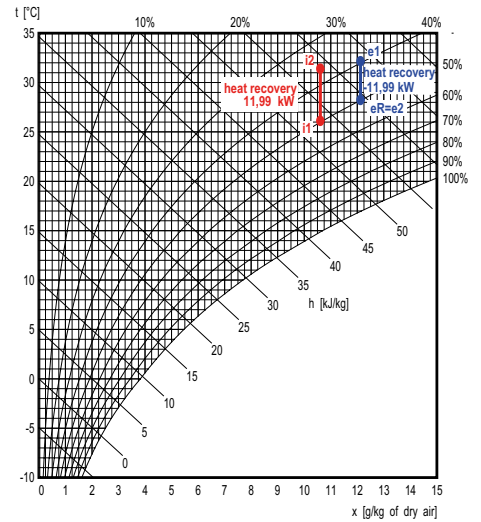
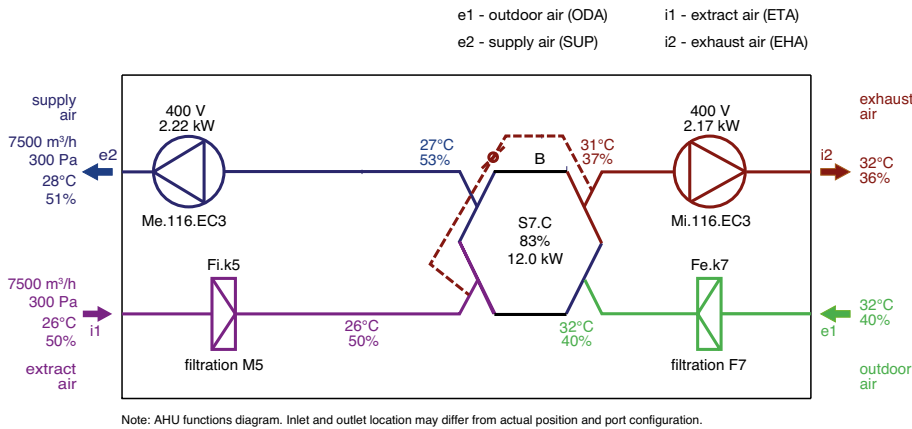

Supply

	Description	t [°C]	RH [%]
e1	Outdoor Air	32.0	40
e2	Supply Air	27.9	51

Exhaust

	Description	t [°C]	RH [%]
i1	Extract Air	26.0	50
i2	Exhaust Air	31.6	36

FILTERS

Filtration	Supply	Extract	Accessories (part of delivery)
Type	Pleated Cartridge		Pfe dirty filter pressure switch for supply air Pfi dirty filter pressure switch for extract air
Filtration class	ePM2,5 65 % (F7)	ePM10 70 % (M5)	
Number of filters	1+3	1+3	
Filter cartridge size	750x250x96 750x405x96	750x250x96 750x405x96	

Duplexvent Multi eco DV7500

Commercial MVHR with cross-counter-flow heat exchanger - Indoor

OPTIONAL ACCESSORIES

ELECTRIC PRE-HEATER

Electric pre-heater		Supply
Air volume	m ³ /h / l/s	7000 / 1944
Maximum heating capacity	kW	54.0
Voltage	V	400
Connection ports	mm	800x500

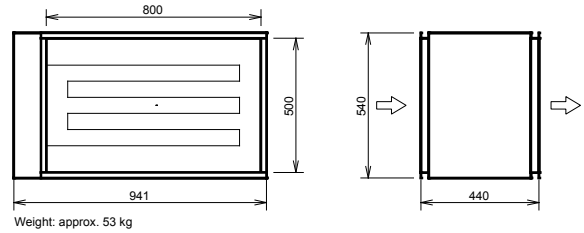

WATER HEATING COIL

Water heating coil		Supply
Heating medium		Water
Air volume	m ³ /h / l/s	7000 / 1944
Temperature at inlet (after heat recovery)	°C	17
Temperature at outlet (downstream of the heater)	°C	19
Heating capacity	kW	5.8
Heating medium temperature drop	°C	70/50
Medium flow (from source)	l/h	249
Connection dimension (hydraulic kit)		1" female

Note: The figures above have been measured at 7000 m³/h and 300 Pa. Please use the Duplexvent Selection Software to calculate measurements at other performance levels.

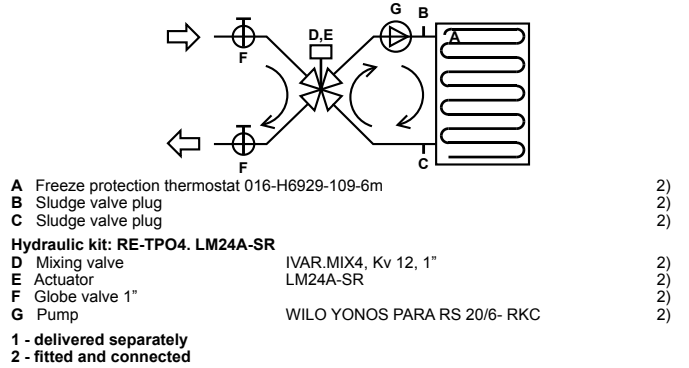

HEATING CAPACITY

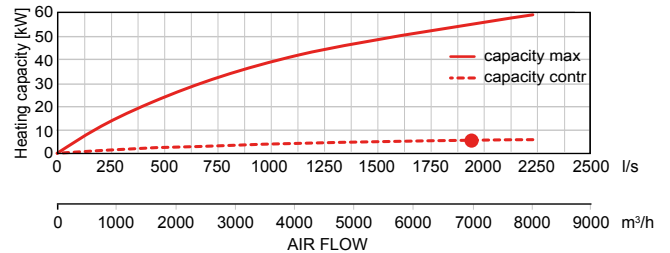

WATER COOLING COIL

Water cooling coil		Supply
Cooling medium		21% Ethylene glycol
Air volume	m ³ /h / l/s	7000 / 1944
Temperature at inlet (after heat recovery)	°C	27
Temperature at outlet (downstream of the cooling coil)	°C	17
Inlet relative humidity (after heat recovery)	% RH	53
Outlet relative humidity (downstream of the cooling coil)	% RH	97
Cooling capacity	kW	23.1
Condensate production	l/h	1
Water temperature drop	°C	6 / 12
Medium flow (at max. capacity)	l/h	3480
Medium-side pressure drop		
in heat exchanger	kPa	3.75
in valve	kPa	11.84
Connection dimension		1" female

Note: The figures above have been measured at 7000 m³/h and 300 Pa. Please use the Duplexvent Selection Software to calculate measurements at other performance levels.

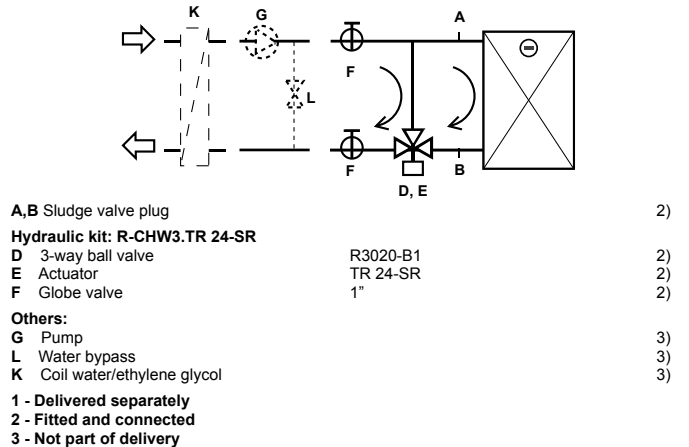

COOLING CAPACITY

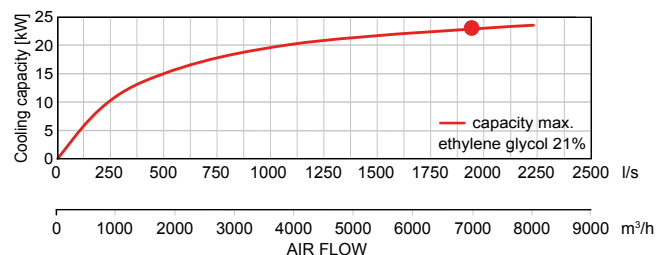

DX COIL

DX coil		Supply
Air volume	m ³ /h / l/s	7000 / 1944
Temperature at inlet (after heat recovery)	°C	27
Temperature at outlet (downstream of the DX coil)	°C	17
Inlet relative humidity (after heat recovery)	% RH	53
Outlet relative humidity (downstream of the DX coil)	% RH	78
Cooling capacity	kW	28.09
Condensate production	l/h	21
Refrigerant type		R410A
Evaporating temperature	°C	11

Note: The figures above have been measured at 7000 m³/h and 300 Pa. Please use the Duplexvent Selection Software to calculate measurements at other performance levels.

COOLING CAPACITY

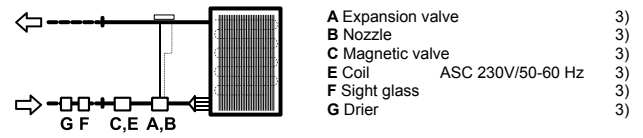
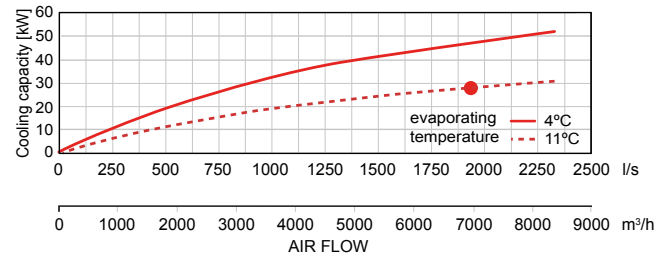

3 Not part of delivery, recommended type mentioned

DIMENSIONS

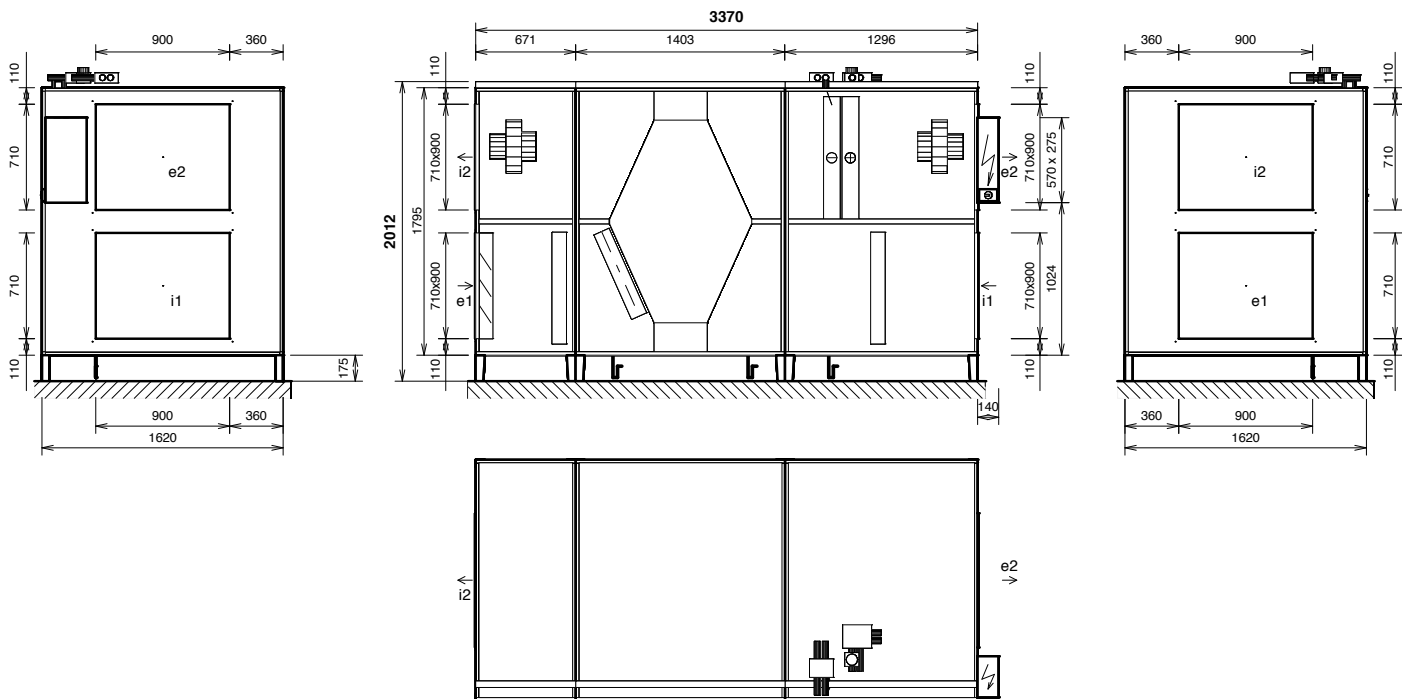

Connections	Type	Dimensions	Optional components
e1	e1- outdoor air (ODA)	710x900mm	Shutoff damper, Flexible connection
e2	e2- supply air (SUP)	710x900mm	Flexible connection
i1	i1- extract air (ETA)	710x900mm	Shutoff damper, Flexible connection
i2	i2- exhaust air (EHA)	710x900mm	Flexible connection
K	condensate drain	3x Ø 32 mm/40 mm	Condensate pump

Notice:

- Unit supplied as three pieces
- Door - 3 parts
- Diagram is intended only for basic information, binding dimensions receive at device delivery, or on request from the manufacturer.
- Bolt holes for duct connection (for one port): 4x M6

Duplexvent Multi eco DV9000

Commercial MVHR with cross-counter-flow heat exchanger - Indoor



KEY FEATURES

- Air volume up to 8000 m³/h at 400 Pa according to ErP 2018
- Digital Touchscreen or simple manual controller
- Low noise, refer to NR35 and BB93 standards
- Excellent thermal insulation (class T2, TB1)
- Filters: ePM2,5 65 % (F7), ePM10 70 % (M5) or Coarse 60 % (G4)
- Optional circulation damper
- Optional constant flow and constant pressure mode
- BREEAM and ErP 2018 compliant
- Meets Building Regulations Part L2A and L2B

PERFORMANCE

Ventilation		Supply Air	Extract Air
Air volume @ 400 Pa	m ³ /h / l/s	8000 / 2222	8000 / 2222
Nominal voltage	V	400	400
Nominal power (at operation point)	kW	2.7	2.6
Fan Speed	min ⁻¹	2101	2125
Max power input	kW	5.2	5.2
Max current	A	8.4	8.4
Fan Type		EC	EC

Note: The figures above have been measured at 8000 m³/h and 400 Pa. Please use the Duplexvent Selection Software to calculate measurements at other performance levels.

AIR FLOW CURVE

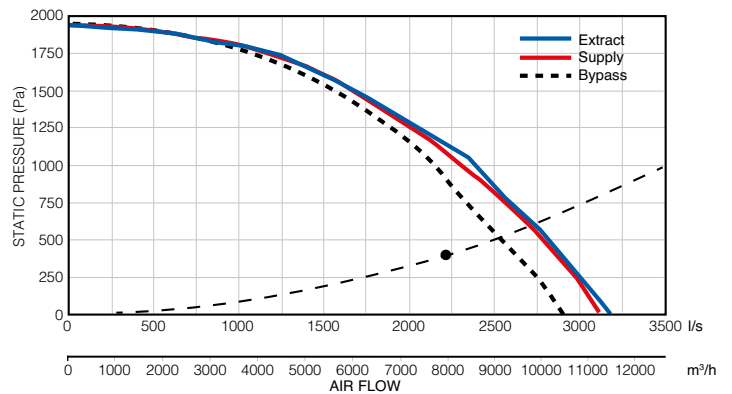

Heat Recovery		Supply Air	Extract Air
Air volume @ 400 Pa	m ³ /h / l/s	8000 / 2222	8000 / 2222
Temperature at inlet	°C	-5	20
Temperature at outlet	°C	17.6	2.7
Humidity at inlet	% RH	90	40
Humidity at outlet	% RH	18	95
Heat recovery efficiency winter / summer	%	88 / 83	
Performance in winter / summer	kW	60.6 / 13.8	
Condensation	l/h	14.4	
Type of heat exchanger		Cross-counter-flow, Plastic	
Part No.		90000800	

Note: The figures above have been measured at 8000 m³/h and 400 Pa. Please use the Duplexvent Selection Software to calculate measurements at other performance levels.

POWER CONSUMPTION

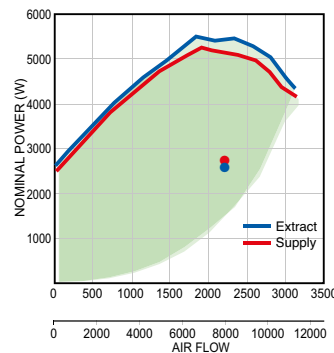

Note: Green area denotes power consumption range. Power consumption depends on system installation.

HEAT RECOVERY EFFICIENCY

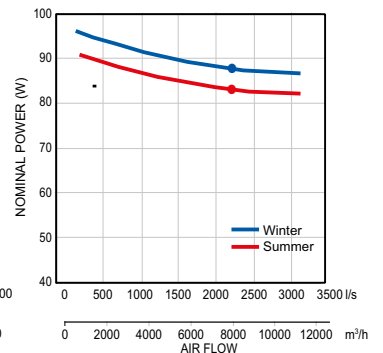

Sound Power Level L _w	Total	63 Hz	125 Hz	250 Hz	500 Hz	1 kHz	2 kHz	4 kHz	8 kHz
	dB (A)								
Outdoor air e1	63	40	42	53	57	61	48	48	<25
Supply air e2	97	68	78	85	92	93	87	80	72
Extract air i1	64	35	45	54	61	60	47	29	<25
Exhaust air i2	97	67	77	84	93	94	87	80	73
Breakout noise	68	47	51	64	61	60	56	51	42
Sound Pressure Level L _p measured at 3m	47	26	31	44	40	40	36	30	<25

Note: The figures above have been measured at 8000 m³/h and 400 Pa. Please use the Duplexvent Selection Software to calculate measurements at other performance levels.

Winter Operation:

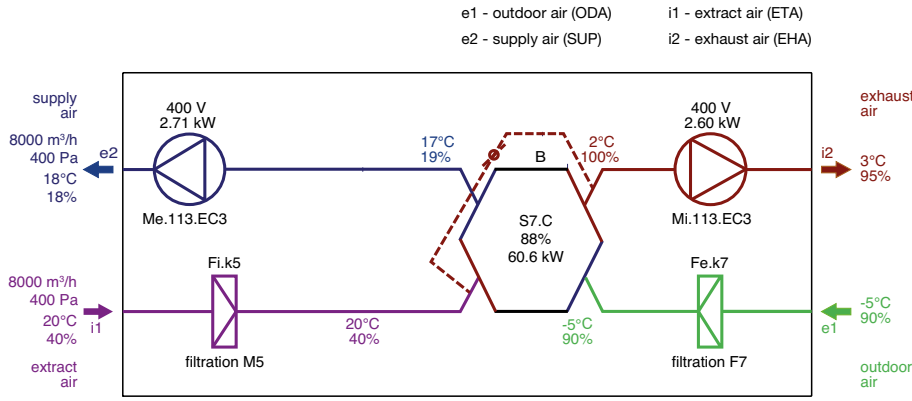

Note: AHU functions diagram. Inlet and outlet location may differ from actual position and port configuration.

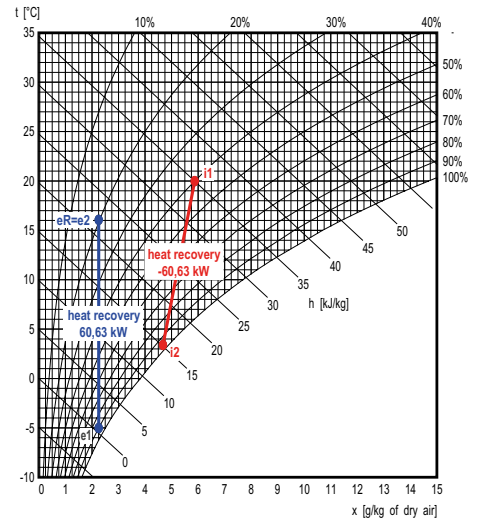

Supply

	Description	t [°C]	RH [%]
e1	Outdoor Air	-5.0	90
e2	Supply Air	17.6	18

Exhaust

	Description	t [°C]	RH [%]
i1	Extract Air	20.0	40
i2	Exhaust Air	2.7	95

Summer Operation:

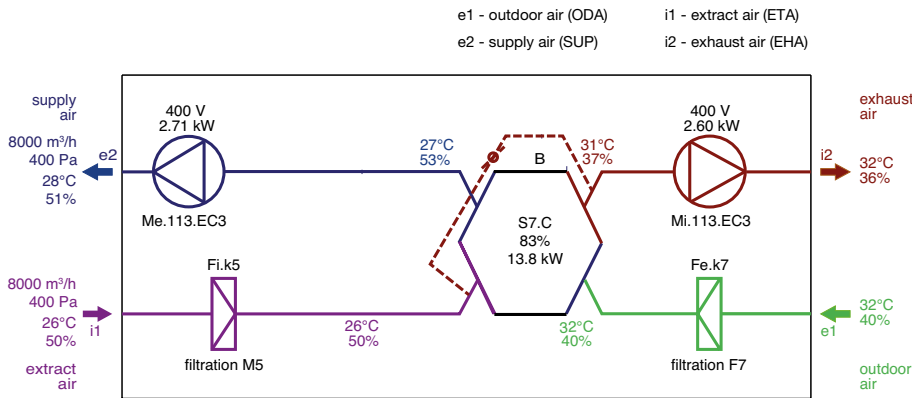

Note: AHU functions diagram. Inlet and outlet location may differ from actual position and port configuration.

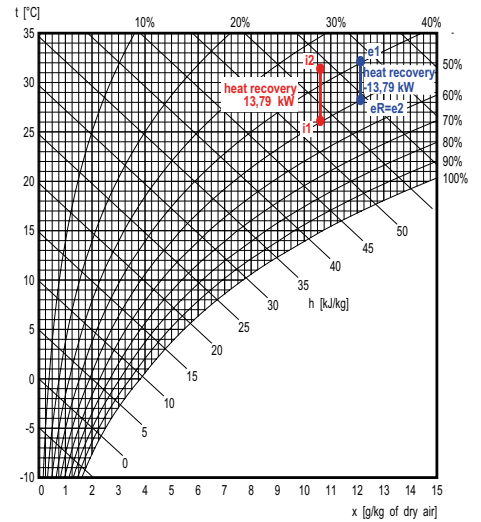

Supply

	Description	t [°C]	RH [%]
e1	Outdoor Air	32.0	40
e2	Supply Air	27.9	51

Exhaust

	Description	t [°C]	RH [%]
i1	Extract Air	26.0	50
i2	Exhaust Air	31.7	36

FILTERS

Filtration		Supply	Extract	Accessories (part of delivery)
Type		Pleated Cartridge		Pfe dirty filter pressure switch for supply air Pfi dirty filter pressure switch for extract air
Filtration class		ePM2,5 65 % (F7)	ePM10 70 % (M5)	
Number of filters	pcs	1+3	1+3	
Filter cartridge size	mm	750x295x96 750x405x96	750x295x96 750x405x96	

Duplexvent Multi eco DV9000

Commercial MVHR with cross-counter-flow heat exchanger - Indoor

OPTIONAL ACCESSORIES

ELECTRIC PRE-HEATER

Electric pre-heater		Supply
Air volume	m ³ /h / l/s	8000 / 2222
Maximum heating capacity	kW	54.0
Voltage	V	400
Connection ports	mm	800x500

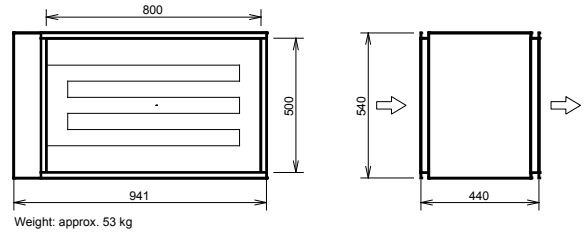

WATER HEATING COIL

Water heating coil		Supply
Heating medium		Water
Air volume	m ³ /h / l/s	8000 / 2222
Temperature at inlet (after heat recovery)	°C	17
Temperature at outlet (downstream of the heater)	°C	19
Heating capacity	kW	5.9
Heating medium temperature drop	°C	70/50
Medium flow (from source)	l/h	252
Connection dimension (hydraulic kit)		1" female

Note: The figures above have been measured at 8000 m³/h and 400 Pa. Please use the Duplexvent Selection Software to calculate measurements at other performance levels.

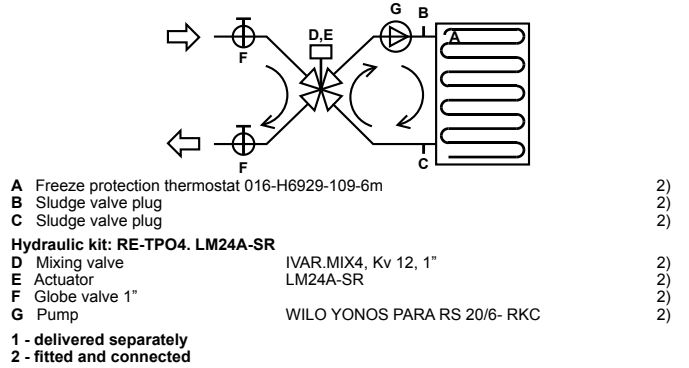

HEATING CAPACITY

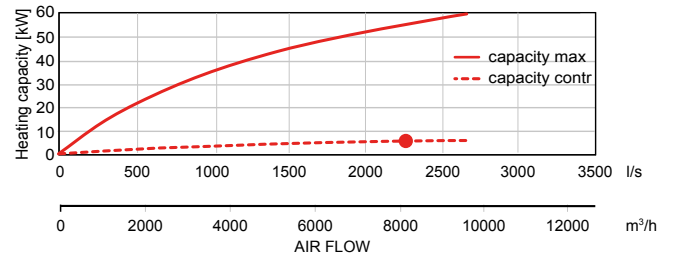

WATER COOLING COIL

Water cooling coil		Supply
Cooling medium		21% Ethylene glycol
Air volume	m ³ /h / l/s	8000 / 2222
Temperature at inlet (after heat recovery)	°C	27
Temperature at outlet (downstream of the cooling coil)	°C	18
Inlet relative humidity (after heat recovery)	% RH	53
Outlet relative humidity (downstream of the cooling coil)	% RH	93
Cooling capacity	kW	24.5
Condensate production	l/h	1
Water temperature drop	°C	6 / 12
Medium flow (at max. capacity)	l/h	3710
Medium-side pressure drop		
in heat exchanger	kPa	4.05
in valve	kPa	13.45
Connection dimension		1" female

Note: The figures above have been measured at 8000 m³/h and 400 Pa. Please use the Duplexvent Selection Software to calculate measurements at other performance levels.

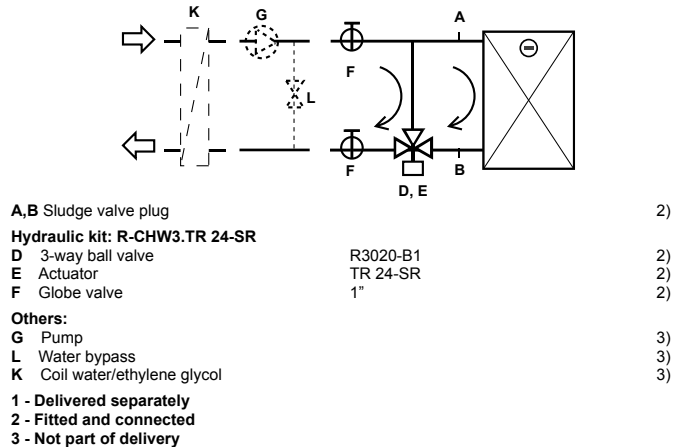

COOLING CAPACITY

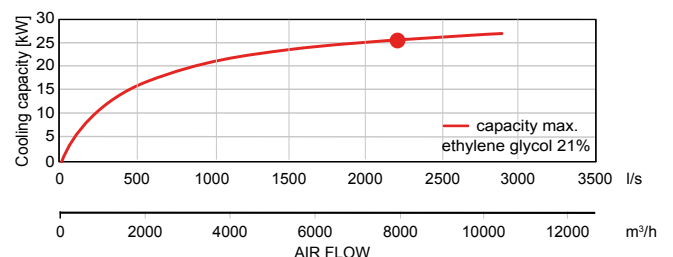

DX COIL

DX coil		Supply
Air volume	m ³ /h / l/s	8000 / 2222
Temperature at inlet (after heat recovery)	°C	27
Temperature at outlet (downstream of the DX coil)	°C	18
Inlet relative humidity (after heat recovery)	% RH	53
Outlet relative humidity (downstream of the DX coil)	% RH	77
Cooling capacity	kW	35.78
Condensate production	l/h	20
Refrigerant type		R410A
Evaporating temperature	°C	5

Note: The figures above have been measured at 8000 m³/h and 400 Pa. Please use the Duplexvent Selection Software to calculate measurements at other performance levels.

COOLING CAPACITY

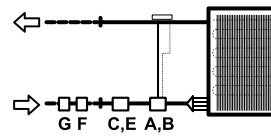
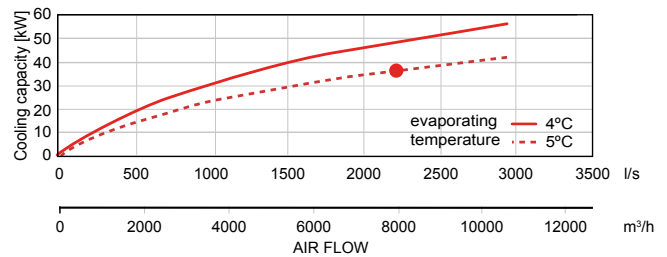

- A Expansion valve (3)
- B Nozzle (3)
- C Magnetic valve (3)
- E Coil ASC 230V/50-60 Hz (3)
- F Sight glass (3)
- G Drier (3)

3 Not part of delivery, recommended type mentioned

DIMENSIONS

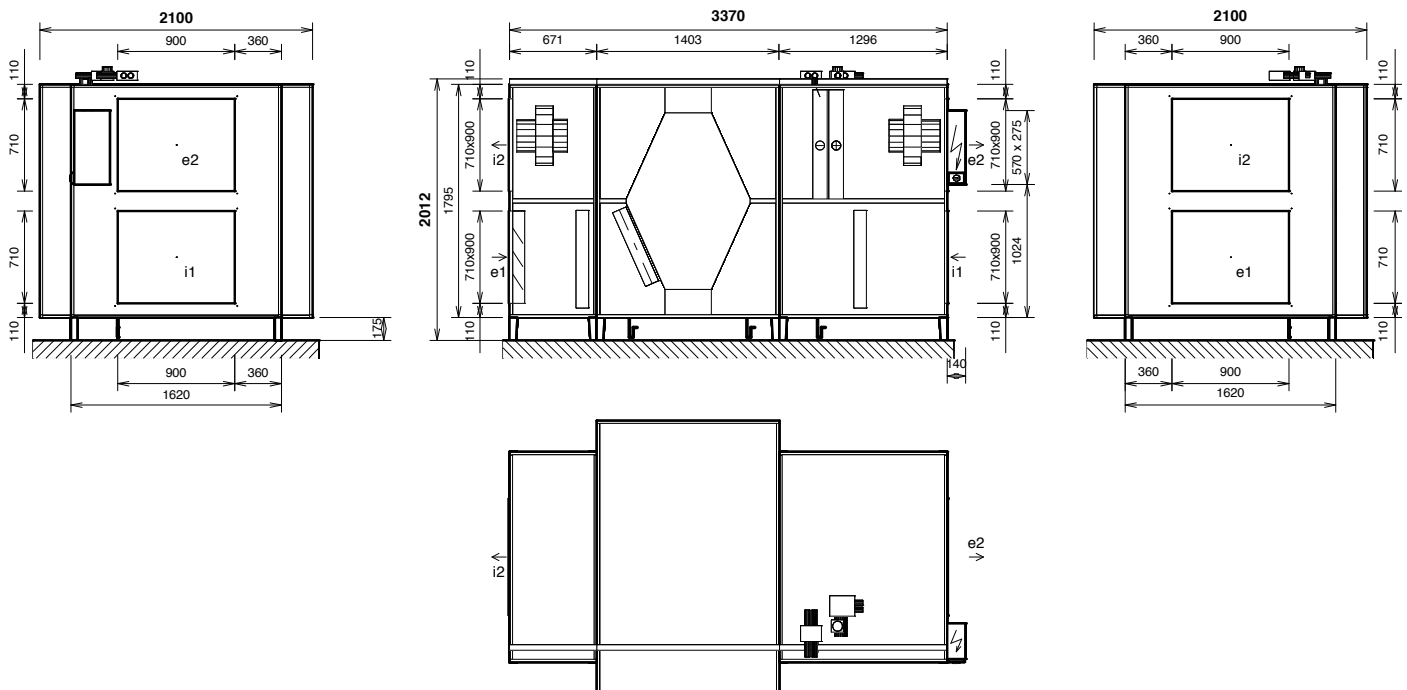

Connections	Type	Dimensions	Optional components
e1	e1- outdoor air (ODA)	710x900mm	Shutoff damper, Flexible connection
e2	e2- supply air (SUP)	710x900mm	Flexible connection
i1	i1- extract air (ETA)	710x900mm	Shutoff damper, Flexible connection
i2	i2- exhaust air (EHA)	710x900mm	Flexible connection
K	condensate drain	3x Ø 32 mm/40 mm	Condensate pump

Notice:

- Unit supplied as three pieces
- Door – 3 parts
- Diagram is intended only for basic information, binding dimensions receive at device delivery, or on request from the manufacturer.
- Bolt holes for duct connection (for one port): 4x M6

Duplexvent Multi eco-V

Heat Recovery Ventilation



KEY FEATURES

- Heat recovery ventilation
- 100% customisation
- 93% thermal efficiency
- Vertical duct connections
- Optimised range with more efficient fans
- Automatic 100% bypass
- Built-in heating / cooling coils
- Integrated web server enables to control the unit via internet
- BMS connection (Modbus as a standard, optional BACnet or KNX)
- VAV control compatibility
- 2 year warranty +

DUPLEXVENT MULTI ECO-V

As a specialist ventilation manufacturer, we aim to provide ventilation solutions for commercial applications. Our broad range of top entry Multi eco-V commercial MVHR units offer a flow rate from 1500 to 5500 m³/h.

Part of the wider Multi eco range, we have introduced the top entry Multi eco-V range to ensure that your specification and installation needs are fully met by a unit that offers outstanding performance and quality.

+ excludes motors. Motor warranty one year from date of purchase.

DUPLEXVENT MULTI ECO-V LINE UNIT CONFIGURATION

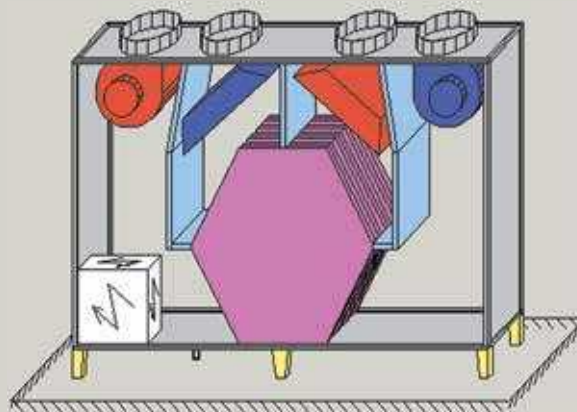

Floor Standing with Upright Duct Connections

(Maintenance access from the side)



100% CUSTOMISATION

Multi eco-V Line range follow the business philosophy of Multiple variability. Designers can easily modify unit positions, spigot connections, filters, integral heating /cooling coils, bypass and circulation dampers using the selection software which

accelerates the specification process and helps meet stringent project requirements.

Thanks to the use of selection software Multi eco-V units are tailored to the individual needs of each customer.



DUPLEXVENT MULTI ECO-V SIZE RANGE

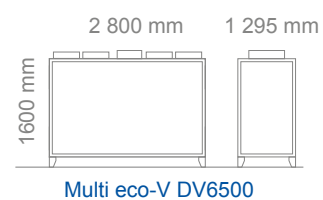
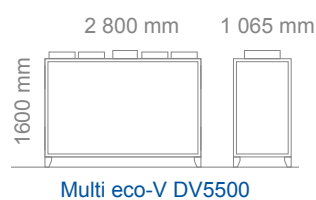
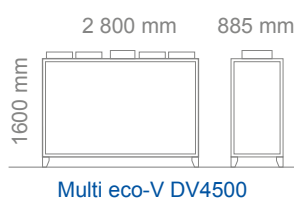
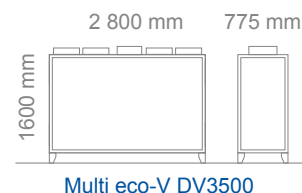
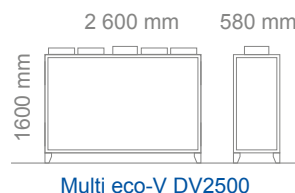
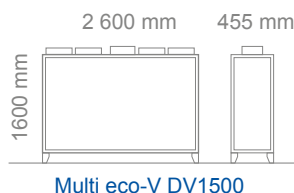

Duplexvent Multi eco-V

Top entry indoor unit

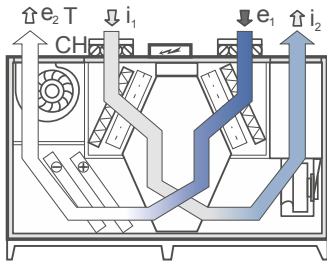

Heat recovery mode
with optional heating and cooling

➡ e_1 ...Outdoor air (ODA)
↻ e_2 ...Supply air (SUP)

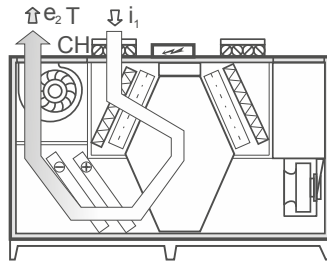

Recirculation mode
with optional heating and cooling

↻ i_1 ...Extract air (ETA)
↻ i_2 ...Exhaust air (EHA)

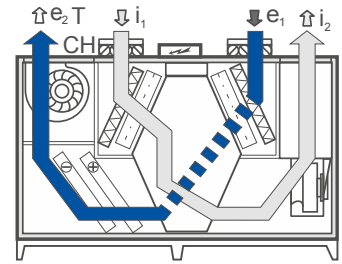

Bypass mode
(without heat recovery)

T ...Central heating connection
CH ...Cooling connection

Duplexvent Multi eco-V		DV1500	DV2500	DV3500	DV4500	DV5500	DV6500
Maximum air flow according to ErP 2018	m ³ /h / l/s	1500/417	2000/556	3000/833	3500/972	4500/1250	5500/1528
Reference external static pressure	Pa	200	200	200	200	300	300
Heat recovery efficiency	%	see curve					
Fan type		EC (backward curved impeller)					
Weight ¹	kg	210-290	300-380	360-430	380-460	490-570	590-680
Max power input	kW	1.2	2.3	5	5	6.6	6.6
Voltage	V	230	400				
Frequency	Hz	50					
Fan speed	min-1	2920	3000	2980	2980	2700	2700
Heating output T - max. ²	kW	22	30	42	51	71	88
Cooling output CHW - max. ²	kW	16	22	30	42	56	62
Cooling output CHF - max. ²	kW	10	13	25	37	41	50
Part No.		90000801	90000802	90000803	90000804	90000805	90000806

1. Depending on equipment

2. Depending on flow rate, external air temperature, medium type

T - Water heating coil

CHW - Water cooling coil

CHF - DX (direct expansion) coil

PERFORMANCE

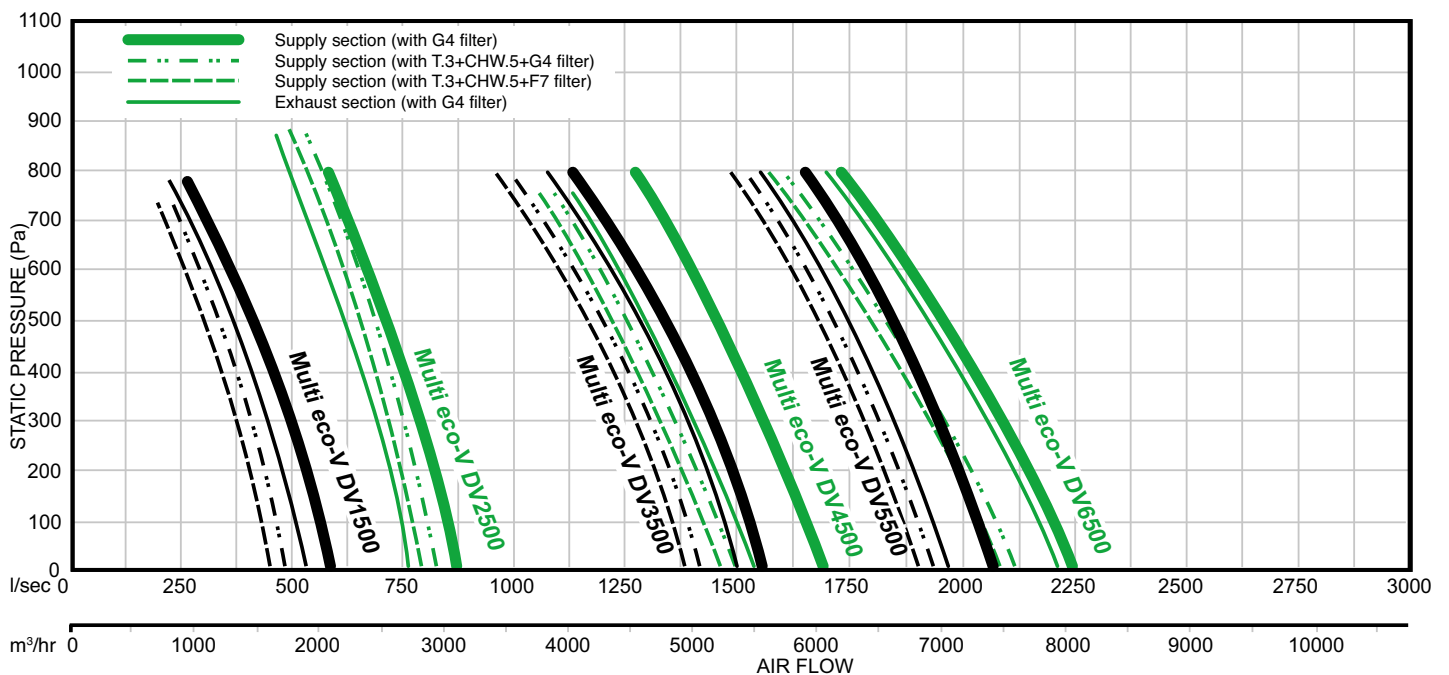

HEATING AND COOLING CAPACITY

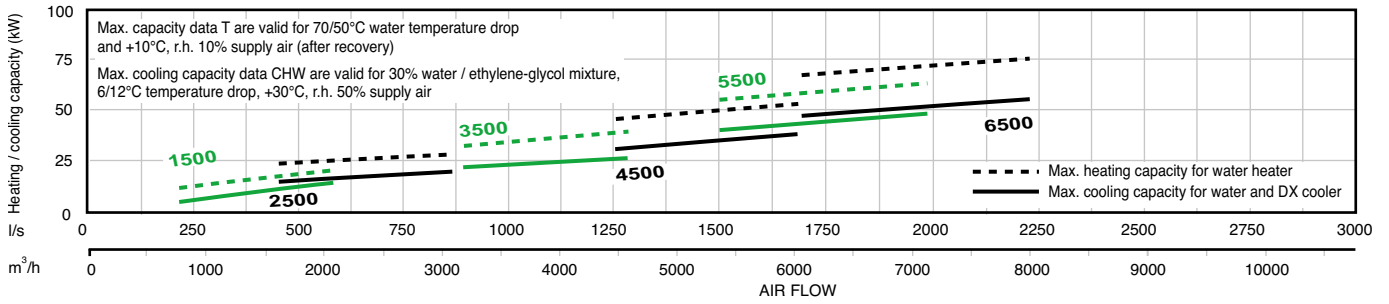

HEAT RECOVERY EFFICIENCY

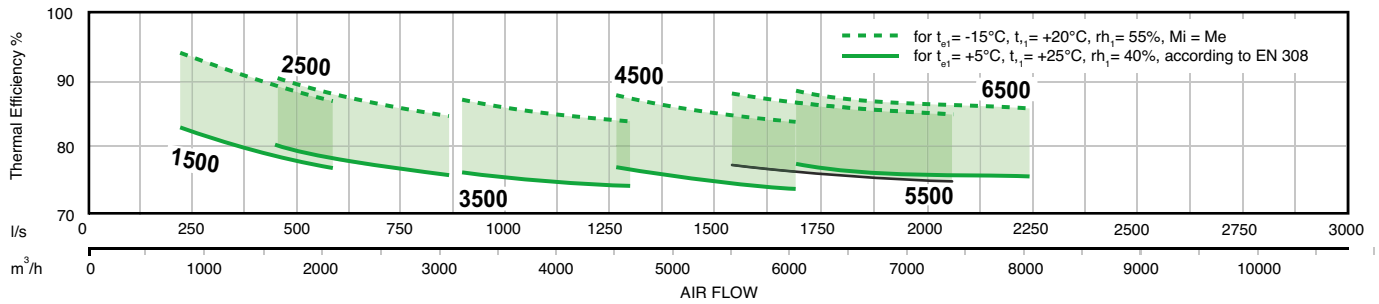

CONNECTION PORTS

Basic port (inlet, outlet)

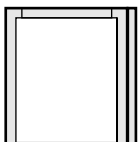

Port with flexible flange (inlet, outlet)

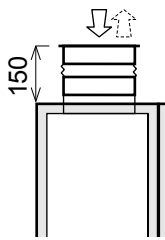

Port with damper (inlet, only)

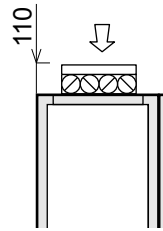

Port with damper and flexible flange (inlet, only)

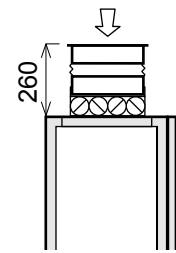

Note: For detailed information we recommend using Duplexvent selection software available at airflow.com

Duplexvent Multi eco-V

Heat Recovery Ventilation

INSTALLATION CONFIGURATION

DUPLEXVENT MULTI ECO-V INSTALLATION POSITIONS AND PORT CONFIGURATIONS

The Duplexvent Multi eco-V range is available in two configurations depending on the spigots location.

For a detailed unit design we recommend a Duplexvent selection software to be used; available at www.airflow.com

All Duplexvent Multi eco-V units are available with a wide range of accessories. For example, the ports can be fitted with flexible flanges and shut-off dampers if required.

Up right position

Multi eco-V 1500 to 6500

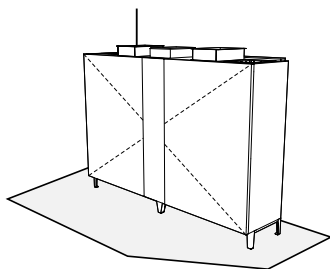

Configuration 50/0 - door-side view

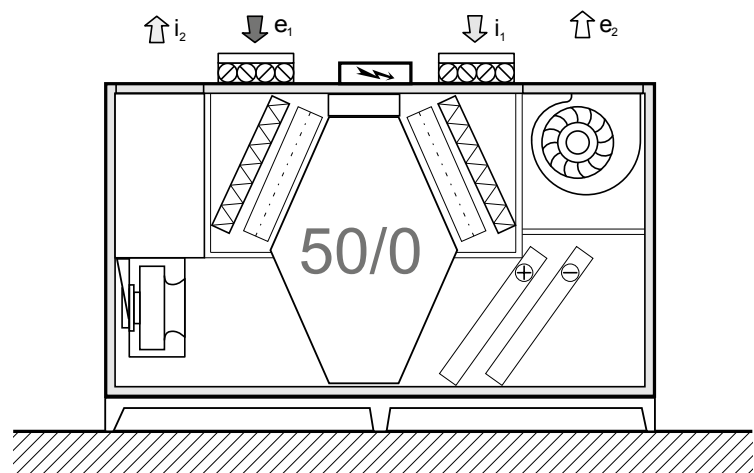

Configuration 51/0 - door-side view

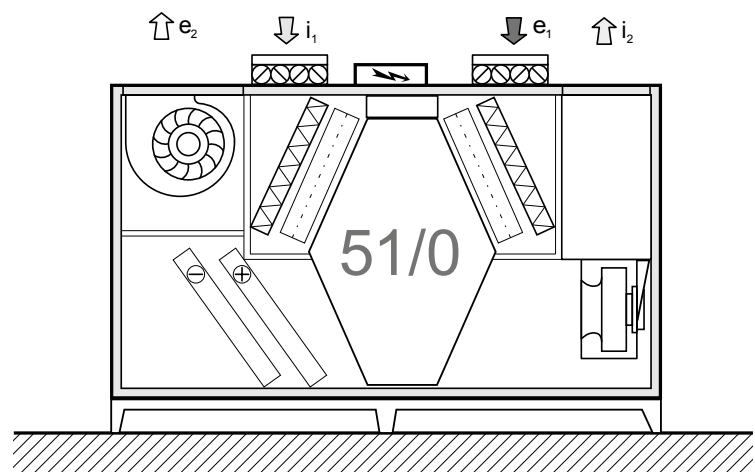

Note: For detailed information we recommend using Duplexvent selection software available at airflow.com

MANIPULATION SPACE

DUPLEXVENT MULTI ECO-V MANIPULATION SPACE

Duplexvent Multi eco-V units must be installed with the unit's handling space (outlined below) in mind.

There must be a 150 mm gap underneath the unit to install the condensate drain system, as the system must run through a U-bend at least 150 mm high into the sewer. This space is easily achieved when the supporting feet, which are supplied as standard, are used when the unit is installed. The handling space in front of the unit must be maintained so the unit can be serviced.

In addition the handling spaces outlined below, there must be a minimum 600 mm space from the side of electric switchboard of the control system.

Units fitted with additional heaters or coolers must have free space from the side of the manifold.

MANIPULATION SPACE, UNIT CONFIGURATION

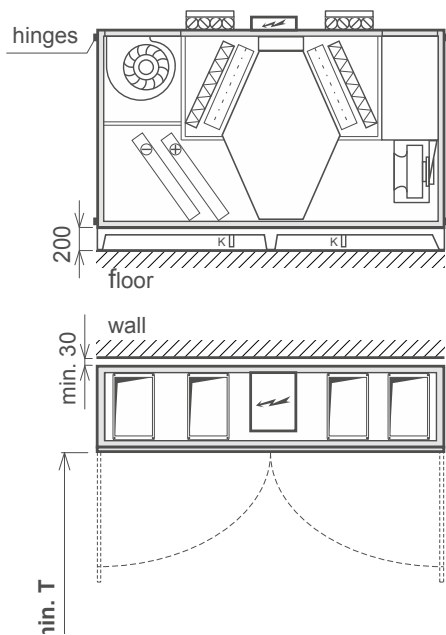

MANIPULATION SPACE FOR UNIT ACCESSORIES

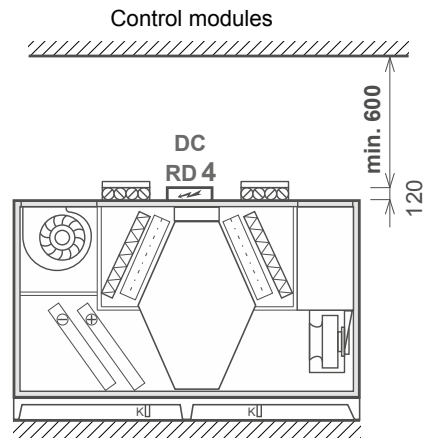

Duplexvent Multi eco-V	Standard door T [mm]	Hingeless door T [mm]
DV1500	1400	500
DV2500	1400	600
DV3500	1500	680
DV4500	1500	900
DV5500	1500	1100
DV6500	1500	1300

Duplexvent Multi eco-V DV1500

Commercial MVHR with cross-counter-flow heat exchanger - Indoor



KEY FEATURES

- Air volume up to 1500 m³/h at 200 Pa according to ErP 2018
- Digital Touchscreen or simple manual controller
- Low noise, refer to NR35 and BB93 standards
- Excellent thermal insulation (class T2, TB1)
- Filters: ePM2,5 65 % (F7), ePM10 70 % (M5) or Coarse 60 % (G4)
- Optional circulation damper
- Optional constant flow and constant pressure mode
- BREEAM and ErP 2018 compliant
- Meets Building Regulations Part L2A and L2B

PERFORMANCE

Ventilation		Supply Air	Extract Air
Air volume @ 400 Pa	m ³ /h / l/s	1500 / 417	1500 / 417
Nominal voltage	V	230	230
Nominal power (at operation point)	kW	0.44	0.45
Fan Speed	min ⁻¹	2589	2696
Max power input	kW	0.78	0.78
Max current	A	3.9	3.9
Fan Type		EC	EC

Note: The figures above have been measured at 1500 m³/h and 200 Pa. Please use the Duplexvent Selection Software to calculate measurements at other performance levels.

AIR FLOW CURVE

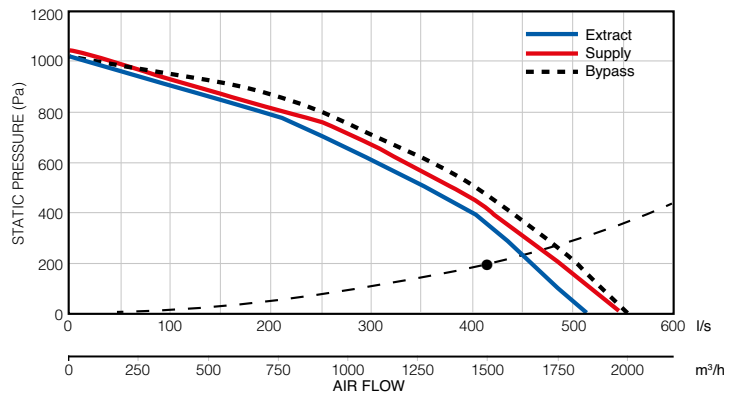

Heat Recovery		Supply Air	Extract Air
Air volume @ 200 Pa	m ³ /h / l/s	1500 / 417	1500 / 417
Temperature at inlet	°C	-5	20
Temperature at outlet	°C	17.6	2.6
Humidity at inlet	% RH	90	40
Humidity at outlet	% RH	18	95
Heat recovery efficiency winter / summer	%	88 / 83	
Performance in winter / summer	kW	11.4 / 2.6	
Condensation	l/h	2.7	
Type of heat exchanger		Cross-counter-flow, Plastic	
Part No.		90000801	

Note: The figures above have been measured at 1500 m³/h and 200 Pa. Please use the Duplexvent Selection Software to calculate measurements at other performance levels.

POWER CONSUMPTION

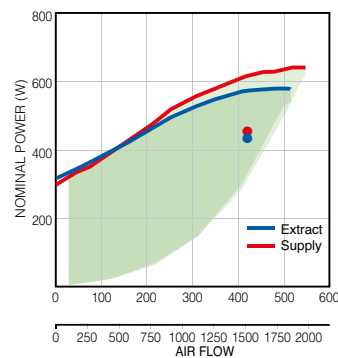

Note: Green area denotes power consumption range. Power consumption depends on system installation.

HEAT RECOVERY EFFICIENCY

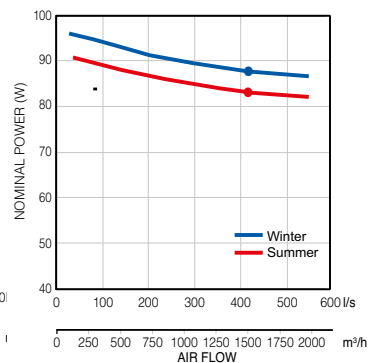

Sound Power Level L _w	Total	63 Hz	125 Hz	250 Hz	500 Hz	1 kHz	2 kHz	4 kHz	8 kHz
	dB (A)								
Outdoor air e1	53	34	43	52	43	40	33	27	<25
Supply air e2	81	61	70	77	72	74	72	62	59
Extract air i1	61	43	50	59	54	49	40	<25	<25
Exhaust air i2	82	65	70	79	75	74	73	63	59
Breakout noise	67	42	54	63	63	61	55	42	31
Sound Pressure Level L_p measured at 3m	47	<25	33	42	42	40	34	<25	<25

Note: The figures above have been measured at 1500 m³/h and 200 Pa. Please use the Duplexvent Selection Software to calculate measurements at other performance levels.

Winter Operation:

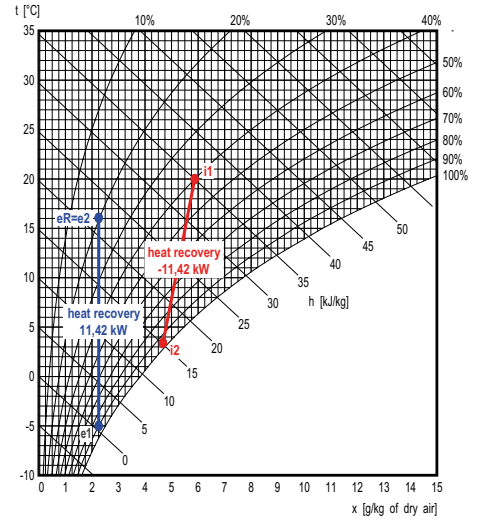
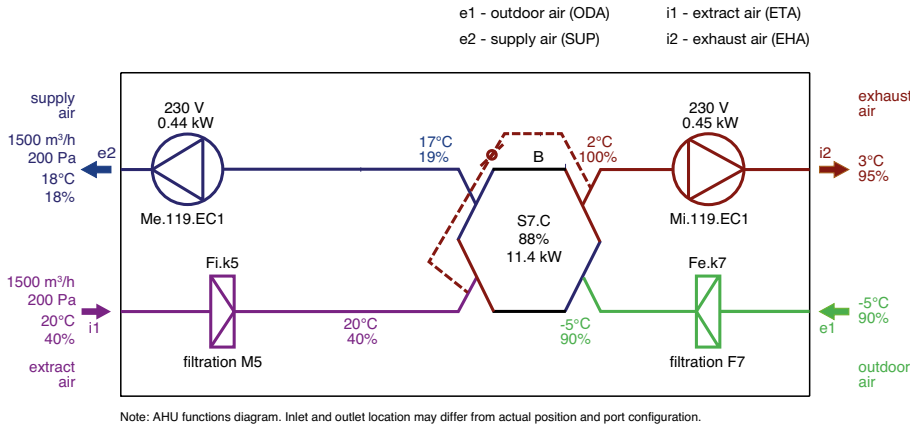

Supply

	Description	t [°C]	RH [%]
e1	Outdoor Air	-5.0	90
e2	Supply Air	17.6	18

Exhaust

	Description	t [°C]	RH [%]
i1	Extract Air	20.0	40
i2	Exhaust Air	2.6	95

Summer Operation:

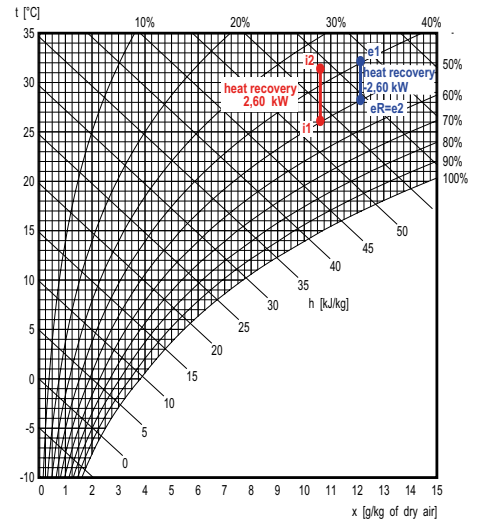
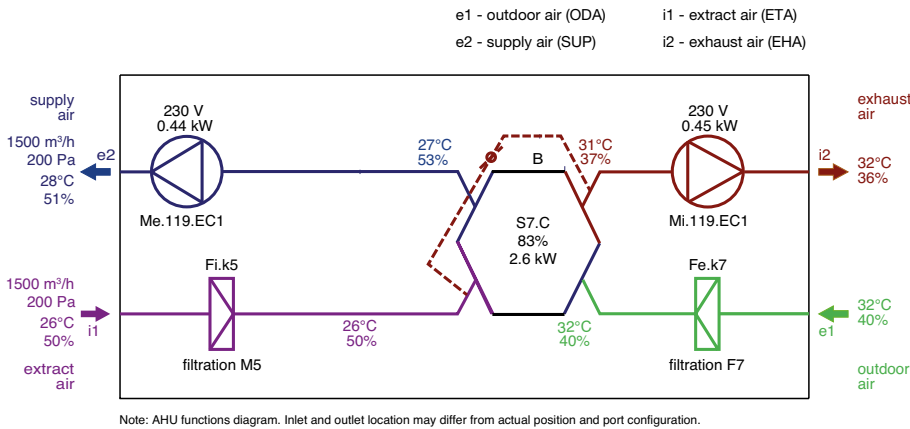

Supply

	Description	t [°C]	RH [%]
e1	Outdoor Air	32.0	40
e2	Supply Air	27.8	51

Exhaust

	Description	t [°C]	RH [%]
i1	Extract Air	26.0	50
i2	Exhaust Air	31.7	36

FILTERS

Filtration	Supply	Extract	Accessories (part of delivery)
Type	Pleated Cartridge		Pfe dirty filter pressure switch for supply air Pfi dirty filter pressure switch for extract air
Filtration class	ePM2,5 65 % (F7)	ePM10 70 % (M5)	
Number of filters	pcs 1	1	
Filter cartridge size	mm 600x380x96	600x380x96	

Duplexvent Multi eco-V DV1500

Commercial MVHR with cross-counter-flow heat exchanger - Indoor

OPTIONAL ACCESSORIES

ELECTRIC PRE-HEATER

Electric pre-heater		Supply
Air volume	m ³ /h / l/s	1500 / 417
Maximum heating capacity	kW	3.0
Voltage	V	400
Connection ports	mm	Ø315

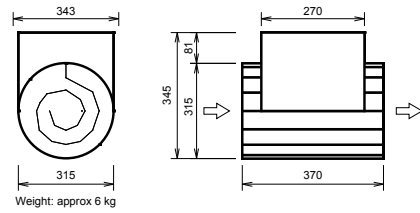

WATER HEATING COIL

Water heating coil		Supply
Heating medium		Water
Air volume	m ³ /h / l/s	1500 / 417
Temperature at inlet (after heat recovery)	°C	17
Temperature at outlet (downstream of the heater)	°C	19
Heating capacity	kW	1.2
Heating medium temperature drop	°C	70/50
Medium flow (from source)	l/h	50
Connection dimension (hydraulic kit)		1" female

Note: The figures above have been measured at 1500 m³/h and 200 Pa. Please use the Duplexvent Selection Software to calculate measurements at other performance levels.

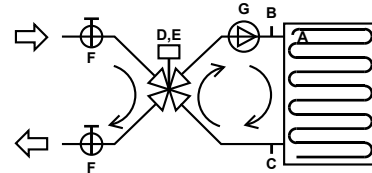

- A Freeze protection thermostat 016-H6927-107-3m 2)
 - B Air vent automatic T 2)
 - C Sludge valve plug 2)
 - Hydraulic kit: RE-TPO4.LM24A-SR
 - D Mixing valve IVAR.MIX4, Kv 12, 1" 1)
 - E Actuator LM24A-SR 1)
 - F Globe valve 1" 1)
 - G Pump WILO YONOS PARA RS 20/6- RKC 1)
- 1 - delivered separately
2 - fitted and connected

HEATING CAPACITY

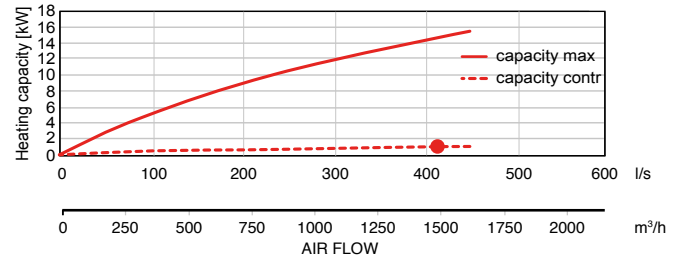

WATER COOLING COIL

Water cooling coil		Supply
Cooling medium		21% Ethylene glycol
Air volume	m ³ /h / l/s	1500 / 417
Temperature at inlet (after heat recovery)	°C	27
Temperature at outlet (downstream of the cooling coil)	°C	16
Inlet relative humidity (after heat recovery)	% RH	53
Outlet relative humidity (downstream of the cooling coil)	% RH	87
Cooling capacity	kW	8.0
Condensate production	l/h	4
Water temperature drop	°C	6 / 12
Medium flow (at max. capacity)	l/h	1360
Medium-side pressure drop		
in heat exchanger	kPa	28.53
in valve	kPa	1.38
Connection dimension		1" female

Note: The figures above have been measured at 1500 m³/h and 200 Pa. Please use the Duplexvent Selection Software to calculate measurements at other performance levels.

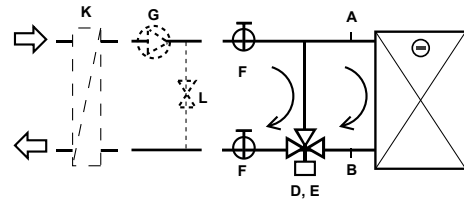

- A Air vent automatic 2)
 - B Sludge valve plug 2)
 - Hydraulic kit: RE-TPO4.E.LM24A-SR
 - D Mixing valve IVAR.MIX4, Kv 12, 1" 1)
 - E Actuator LM24A-SR 1)
 - F Globe valve 1" 1)
 - Others:
 - G Pump WILO YONOS PARA RS 20/6- RKC 1)
- 1 - Delivered separately
2 - Fitted and connected

COOLING CAPACITY

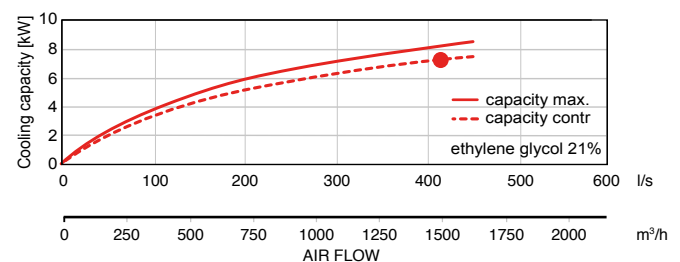

DX COIL

DX coil		Supply
Air volume	m ³ /h / l/s	1500 / 1419
Temperature at inlet (after heat recovery)	°C	27
Temperature at outlet (downstream of the DX coil)	°C	16
Inlet relative humidity (after heat recovery)	% RH	53
Outlet relative humidity (downstream of the DX coil)	% RH	8.07
Cooling capacity	kW	6.8
Condensate production	l/h	5
Refrigerant type		R410A
Evaporating temperature	°C	7

Note: The figures above have been measured at 1500 m³/h and 200 Pa. Please use the Duplexvent Selection Software to calculate measurements at other performance levels.

COOLING CAPACITY

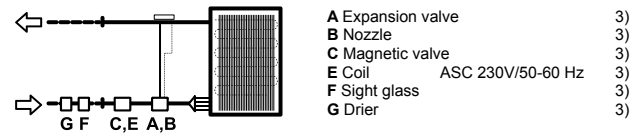
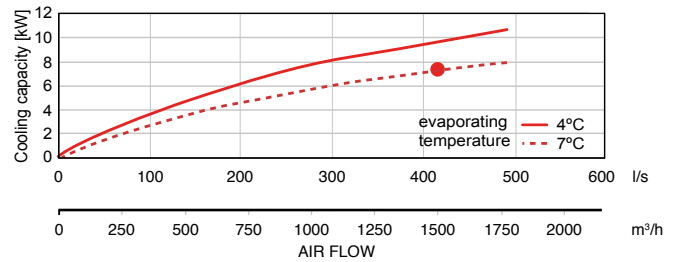

3 Not part of delivery, recommended type mentioned

DIMENSIONS

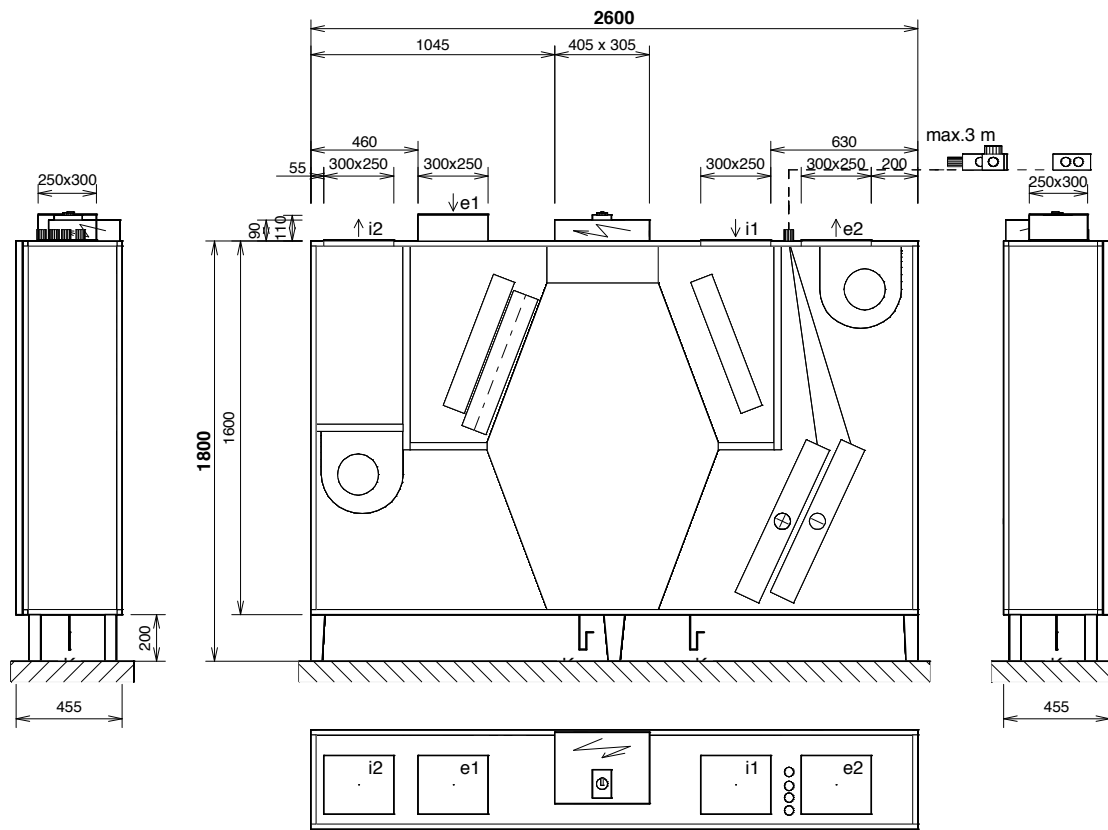

Connections	Type	Dimensions	Optional components
e1	e1- outdoor air (ODA)	300x250mm	Shutoff damper
e2	e2- supply air (SUP)	300x250mm	
i1	i1- extract air (ETA)	300x250mm	
i2	i2- exhaust air (EHA)	300x250mm	
K	condensate drain	2s Ø 32 mm/40 mm	Trap

Notice:
 - Unit supplied as one piece
 - Door – 2 parts
 - Diagram is intended only for basic information, binding dimensions receive at device delivery, or on request from the manufacturer

Duplexvent Multi eco-V DV2500

Commercial MVHR with cross-counter-flow heat exchanger - Indoor



KEY FEATURES

- Air volume up to 2000 m³/h at 200 Pa according to ErP 2018
- Digital Touchscreen or simple manual controller
- Low noise, refer to NR35 and BB93 standards
- Excellent thermal insulation (class T2, TB1)
- Filters: ePM2,5 65 % (F7), ePM10 70 % (M5) or Coarse 60 % (G4)
- Optional circulation damper
- Optional constant flow and constant pressure mode
- BREEAM and ErP 2018 compliant
- Meets Building Regulations Part L2A and L2B

PERFORMANCE

Ventilation		Supply Air	Extract Air
Air volume @ 200 Pa	m ³ /h / l/s	2000 / 556	2000 / 556
Nominal voltage	V	400	400
Nominal power (at operation point)	kW	0.55	0.57
Fan Speed	min ⁻¹	2306	2397
Max power input	kW	2.5	2.5
Max current	A	4	4
Fan Type		EC	EC

Note: The figures above have been measured at 2000 m³/h and 200 Pa. Please use the Duplexvent Selection Software to calculate measurements at other performance levels.

AIR FLOW CURVE

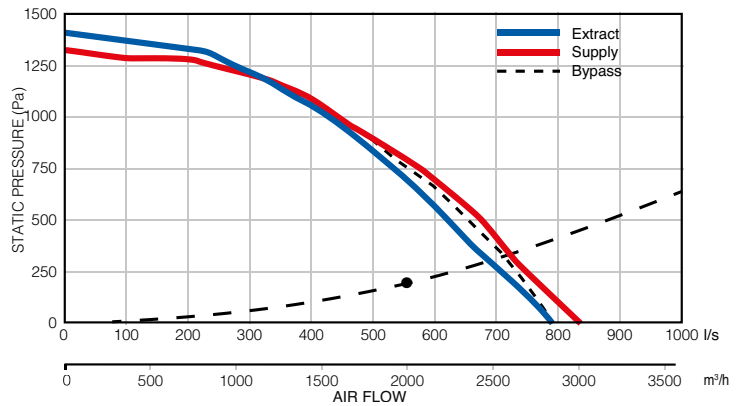

Heat Recovery		Supply Air	Extract Air
Air volume @ 200 Pa	m ³ /h / l/s	2000 / 556	2000 / 556
Temperature at inlet	°C	-5	20
Temperature at outlet	°C	17.6	2.6
Humidity at inlet	% RH	90	40
Humidity at outlet	% RH	18	96
Heat recovery efficiency winter / summer	%	88 / 83	
Performance in winter / summer	kW	15.2 / 3.5	
Condensation	l/h	3.6	
Type of heat exchanger		Cross-counter-flow, Plastic	
Part No.		90000802	

Note: The figures above have been measured at 2000 m³/h and 200 Pa. Please use the Duplexvent Selection Software to calculate measurements at other performance levels.

POWER CONSUMPTION

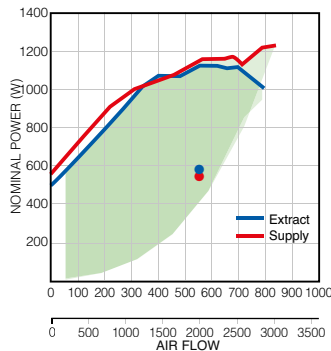

Note: Green area denotes power consumption range. Power consumption depends on system installation.

HEAT RECOVERY EFFICIENCY

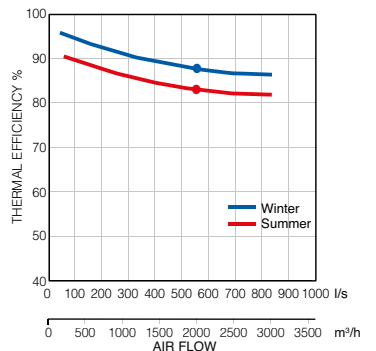

Sound Power Level L _w	Total	63 Hz	125 Hz	250 Hz	500 Hz	1 kHz	2 kHz	4 kHz	8 kHz
	dB (A)								
Outdoor air e1	60	56	51	54	48	47	43	37	27
Supply air e2	86	80	75	80	78	79	75	66	60
Extract air i1	64	60	58	58	56	50	43	25	<25
Exhaust air i2	84	77	77	78	76	76	73	65	59
Breakout noise	70	58	57	65	66	61	55	44	34
Sound Pressure Level L _p measured at 3m	49	37	36	44	46	40	34	<25	<25

Note: The figures above have been measured at 2000 m³/h and 200 Pa. Please use the Duplexvent Selection Software to calculate measurements at other performance levels.

Winter Operation:

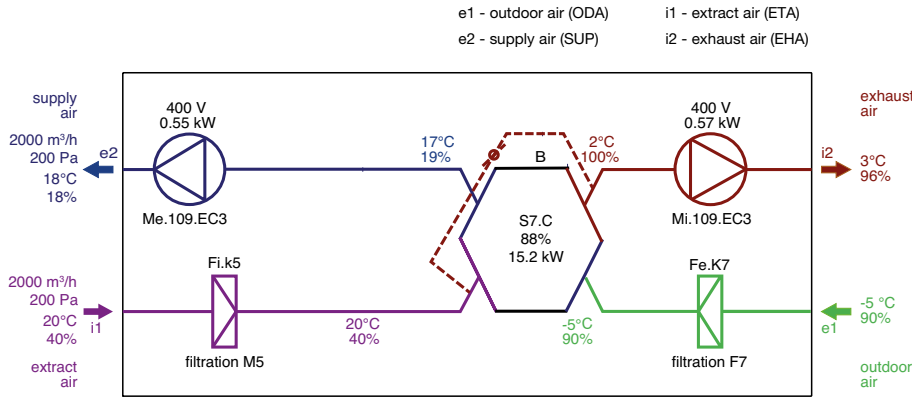

Note: AHU functions diagram. Inlet and outlet location may differ from actual position and port configuration.

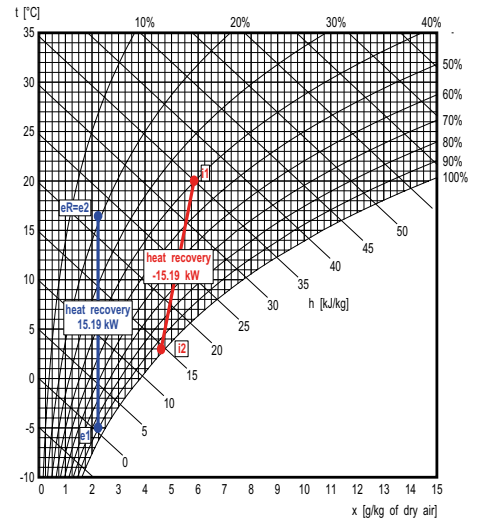

Supply

Description	t [°C]	RH [%]
e1 Outdoor Air	-5.0	90
e2 Supply Air	17.6	18

Exhaust

Description	t [°C]	RH [%]
i1 Extract Air	20.0	40
i2 Exhaust Air	2.6	96

Summer Operation:

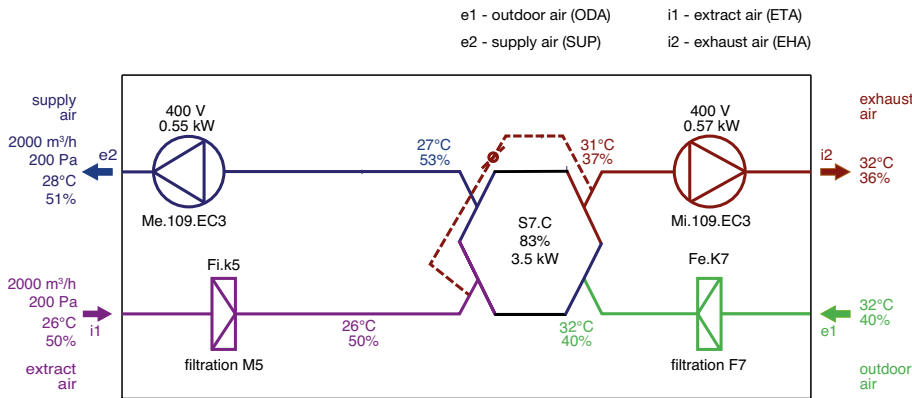

Note: AHU functions diagram. Inlet and outlet location may differ from actual position and port configuration.

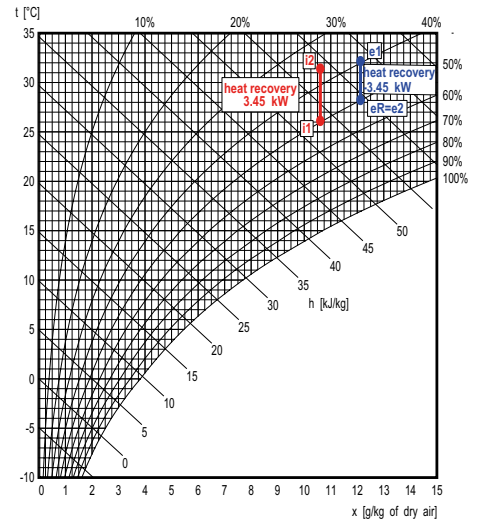

Supply

Description	t [°C]	RH [%]
e1 Outdoor Air	32.0	40
e2 Supply Air	27.7	51

Exhaust

Description	t [°C]	RH [%]
i1 Extract Air	26.0	50
i2 Exhaust Air	31.6	36

FILTERS

Filtration	Supply	Extract	Accessories (part of delivery)
Type	Pleated Cartridge		Pfe dirty filter pressure switch for supply air Pfi dirty filter pressure switch for extract air
Filtration class	ePM2,5 65 % (F7)	ePM10 70 % (M5)	
Number of filters	1	1	
Filter cartridge size	750x495x96	750x495x96	

Duplexvent Multi eco-V DV2500

Commercial MVHR with cross-counter-flow heat exchanger - Indoor

OPTIONAL ACCESSORIES

ELECTRIC PRE-HEATER

Electric pre-heater		Supply
Air volume	m ³ /h / l/s	2000 / 556
Maximum heating capacity	kW	6.0
Voltage	V	400
Connection ports	mm	500x250

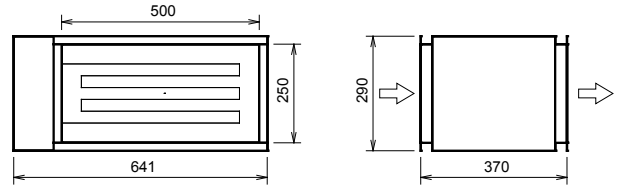

WATER HEATING COIL

Water heating coil		Supply
Heating medium		Water
Air volume	m ³ /h / l/s	2000 / 556
Temperature at inlet (after heat recovery)	°C	17
Temperature at outlet (downstream of the heater)	°C	19
Heating capacity	kW	1.5
Heating medium temperature drop	°C	70/50
Medium flow (from source)	l/h	66
Connection dimension (hydraulic kit)		1" female

Note: The figures above have been measured at 2000 m³/h and 200 Pa. Please use the Duplexvent Selection Software to calculate measurements at other performance levels.

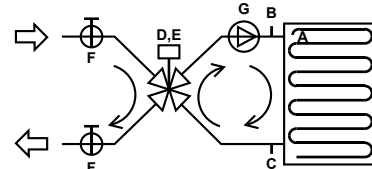

- A Freeze protection thermostat 016-H6927-107-3m 2)
 - B Air vent automatic 2)
 - C Sludge valve plug 2)
 - Hydraulic kit: RE-TPO4.E.LM24A-SR
 - D Mixing valve IVAR.MIX4, Kv 12, 1" 1)
 - E Actuator LM24A-SR 1)
 - F Globe valve 1" 1)
 - G Pump WILO YONOS PARA RS 20/6- RKC 1)
- 1 - delivered separately
2 - fitted and connected

HEATING CAPACITY

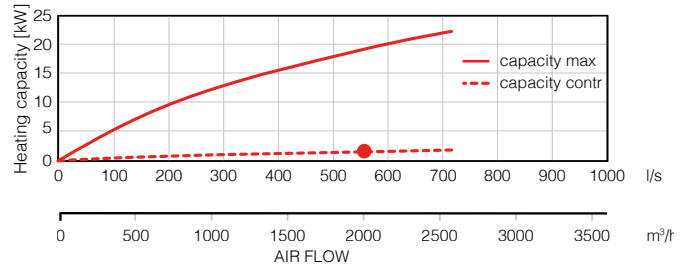

WATER COOLING COIL

Water cooling coil		Supply
Cooling medium		21% Ethylene glycol
Air volume	m ³ /h / l/s	2000 / 556
Temperature at inlet (after heat recovery)	°C	27
Temperature at outlet (downstream of the cooling coil)	°C	16
Inlet relative humidity (after heat recovery)	% RH	53
Outlet relative humidity (downstream of the cooling coil)	% RH	86
Cooling capacity	kW	11.0
Condensate production	l/h	5
Water temperature drop	°C	6 / 12
Medium flow (at max. capacity)	l/h	1920
Medium-side pressure drop		
in heat exchanger	kPa	28.93
in valve	kPa	3.61
Connection dimension		1" female

Note: The figures above have been measured at 2000 m³/h and 200 Pa. Please use the Duplexvent Selection Software to calculate measurements at other performance levels.

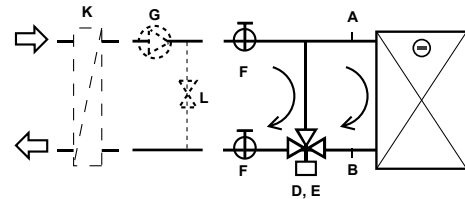

- A Air vent automatic 2)
 - B Sludge valve plug 2)
 - Hydraulic kit: R-CHW3.E.TR 24-SR
 - D 3-way ball valve R3020-B1 1)
 - E Actuator TR 24-SR 1)
 - F Globe valve 1" 1)
 - Others:
 - G Pump 3)
 - L Water bypass 3)
- 1 - Delivered separately
2 - Fitted and connected
3 - Not part of delivery

COOLING CAPACITY

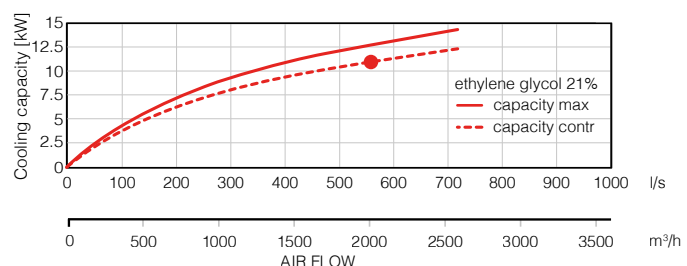

DX COIL

DX coil		Supply
Air volume	m ³ /h / l/s	2000 / 556
Temperature at inlet (after heat recovery)	°C	27
Temperature at outlet (downstream of the DX coil)	°C	17
Inlet relative humidity (after heat recovery)	% RH	53
Outlet relative humidity (downstream of the DX coil)	% RH	79
Cooling capacity	kW	11.0
Condensate production	l/h	7
Refrigerant type		R410A
Evaporating temperature	°C	4

Note: The figures above have been measured at 2000 m³/h and 200 Pa. Please use the Duplexvent Selection Software to calculate measurements at other performance levels.

COOLING CAPACITY

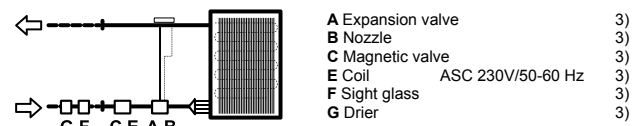
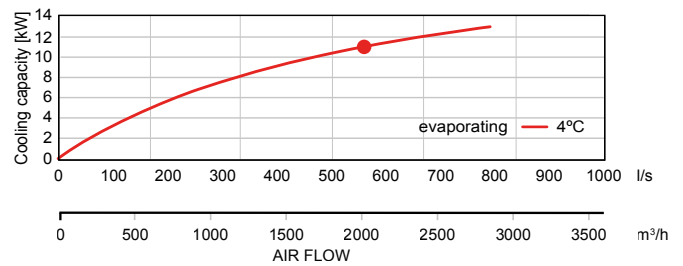

3 Not part of delivery, recommended type mentioned

DIMENSIONS

Position **50/0** upright front view (from the door side)

Weight: approx. **430 kg**

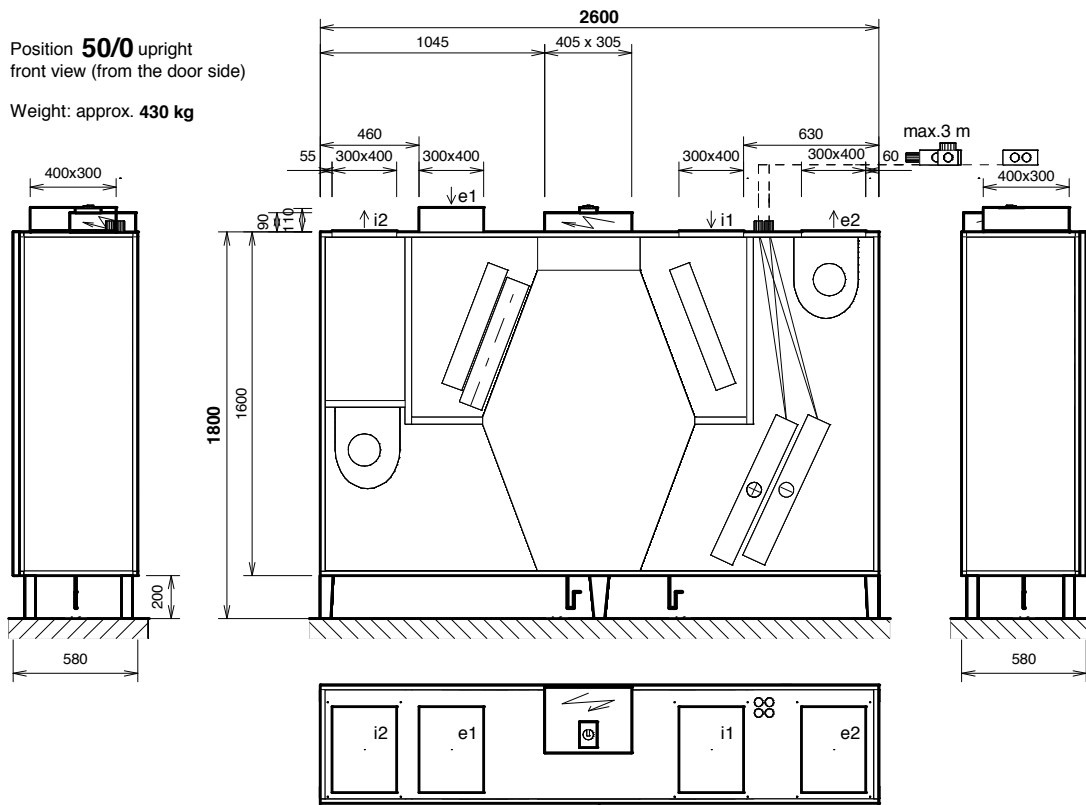

Connections	Type	Dimensions	Optional components
e1	e1- outdoor air (ODA)	300x400mm	Shutoff damper, flexible connection
e2	e2- supply air (SUP)	300x400mm	Flexible connection
i1	i1- extract air (ETA)	300x400mm	Shutoff damper, flexible connection
i2	i2- exhaust air (EHA)	300x400mm	Flexible connection
K	condensate drain	2x Ø 32 mm/40 mm	Condensate pump

Notice:

- Unit supplied as one piece
- Door - 2 parts
- Diagram is intended only for basic information, binding dimensions receive at device delivery, or on request from the manufacturer.
- bolt holes for duct connection (for one port): 4 x M6

Duplexvent Multi eco-V DV3500

Commercial MVHR with cross-counter-flow heat exchanger - Indoor



KEY FEATURES

- Air volume up to 3000 m³/h at 200 Pa according to ErP 2018
- Digital Touchscreen or simple manual controller
- Low noise, refer to NR35 and BB93 standards
- Excellent thermal insulation (class T2, TB1)
- Filters: ePM2,5 65 % (F7), ePM10 70 % (M5) or Coarse 60 % (G4)
- Optional circulation damper
- Optional constant flow and constant pressure mode
- BREEAM and ErP 2018 compliant
- Meets Building Regulations Part L2A and L2B

PERFORMANCE

Ventilation		Supply Air	Extract Air
Air volume @ 200 Pa	m ³ /h / l/s	3000 / 833	3000 / 833
Nominal voltage	V	400	400
Nominal power (at operation point)	kW	0.85	0.8
Fan Speed	min ⁻¹	2079	2006
Max power input	kW	2.5	2.5
Max current	A	3.8	3.8
Fan Type		EC	EC

Note: The figures above have been measured at 3000 m³/h and 200 Pa. Please use the Duplexvent Selection Software to calculate measurements at other performance levels.

AIR FLOW CURVE

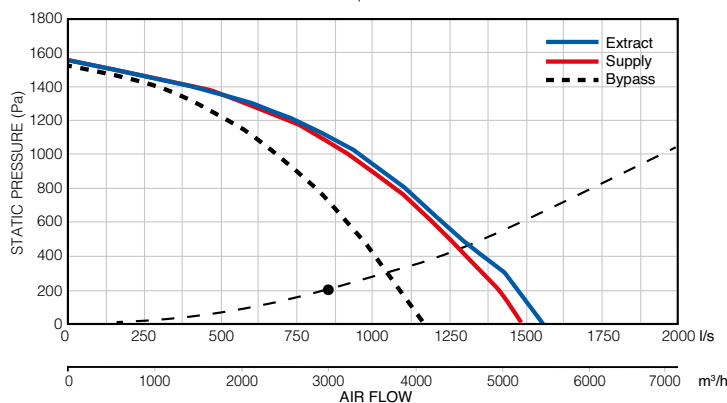

Heat Recovery		Supply Air	Extract Air
Air volume @ 200 Pa	m ³ /h / l/s	3000 / 833	3000 / 833
Temperature at inlet	°C	-5	20
Temperature at outlet	°C	17.3	2.7
Humidity at inlet	% RH	90	40
Humidity at outlet	% RH	18	96
Heat recovery efficiency winter / summer	%	87 / 82	
Performance in winter / summer	kW	22.5 / 5.1	
Condensation	l/h	5.3	
Type of heat exchanger		Cross-counter-flow, Plastic	
Part No.		90000803	

Note: The figures above have been measured at 3000 m³/h and 200 Pa. Please use the Duplexvent Selection Software to calculate measurements at other performance levels.

POWER CONSUMPTION

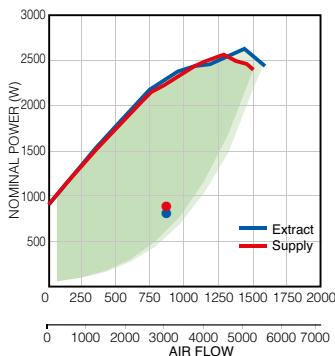

Note: Green area denotes power consumption range. Power consumption depends on system installation.

HEAT RECOVERY EFFICIENCY

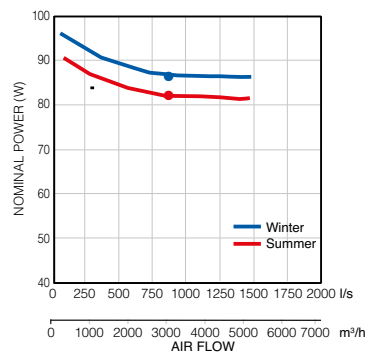

Sound Power Level L _w	Total	63 Hz	125 Hz	250 Hz	500 Hz	1 kHz	2 kHz	4 kHz	8 kHz
	dB (A)								
Outdoor air e1	62	43	50	59	57	52	42	37	26
Supply air e2	89	67	74	82	85	83	77	70	61
Extract air i1	60	40	50	53	58	47	38	26	<25
Exhaust air i2	88	63	72	80	84	81	76	68	60
Breakout noise	71	45	53	68	65	62	61	54	45
Sound Pressure Level L _p measured at 3m	50	25	32	47	44	42	40	34	25

Note: The figures above have been measured at 3000 m³/h and 200 Pa. Please use the Duplexvent Selection Software to calculate measurements at other performance levels.

Winter Operation:

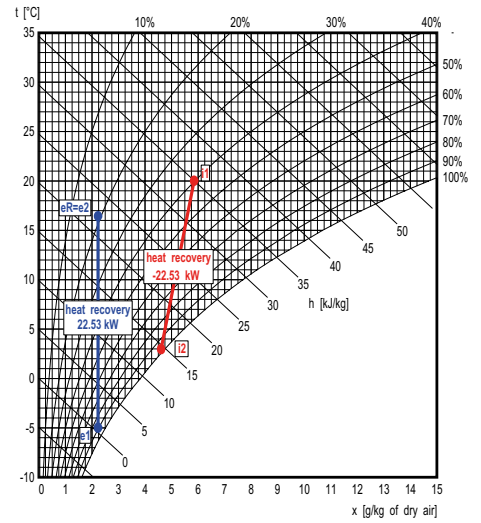
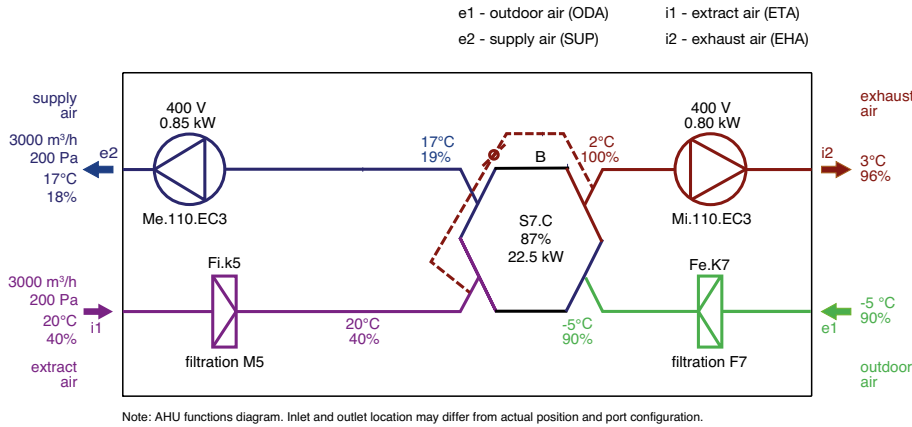

Supply

Description	t [°C]	RH [%]
e1 Outdoor Air	-5.0	90
e2 Supply Air	17.3	18

Exhaust

Description	t [°C]	RH [%]
i1 Extract Air	20.0	40
i2 Exhaust Air	2.7	96

Summer Operation:

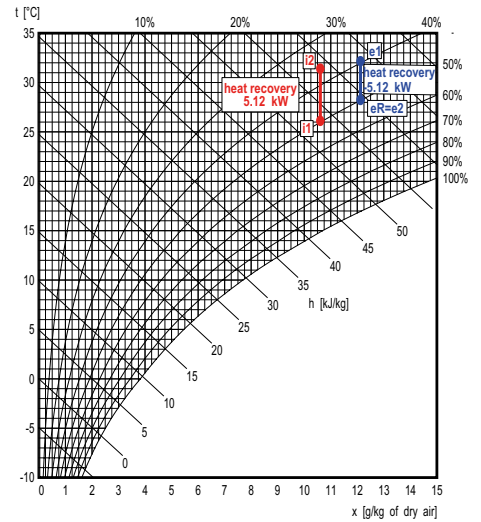
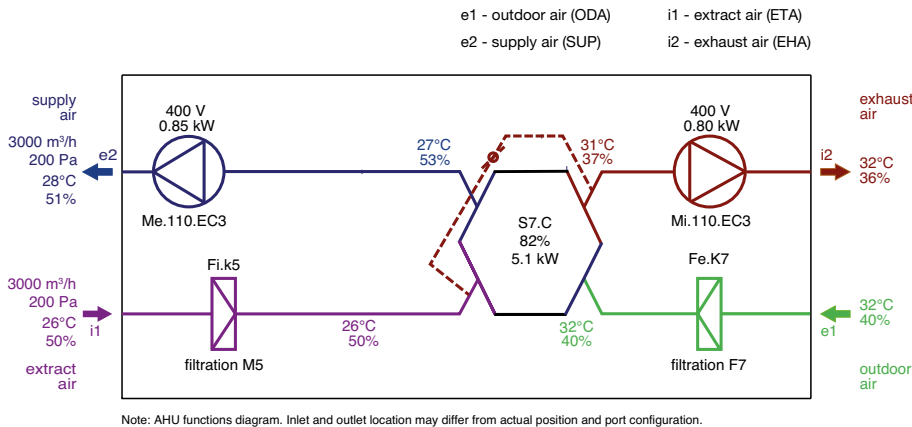

Supply

Description	t [°C]	RH [%]
e1 Outdoor Air	32.0	40
e2 Supply Air	27.8	51

Exhaust

Description	t [°C]	RH [%]
i1 Extract Air	26.0	50
i2 Exhaust Air	31.5	36

FILTERS

Filtration Type	Supply	Extract	Accessories (part of delivery)
	Pleated Cartridge		
Filtration class	ePM2,5 65 % (F7)	ePM10 70 % (M5)	Pfe dirty filter pressure switch for supply air
Number of filters	1+1	1+1	Pfi dirty filter pressure switch for extract air
Filter cartridge size	"750x295x96 750x405x96"	"750x295x96 750x405x96"	

Duplexvent Multi eco-V DV3500

Commercial MVHR with cross-counter-flow heat exchanger - Indoor

OPTIONAL ACCESSORIES

ELECTRIC PRE-HEATER

Electric pre-heater		Supply
Air volume	m ³ /h / l/s	3000 / 833
Maximum heating capacity	kW	9.0
Voltage	V	400
Connection ports	mm	600x300

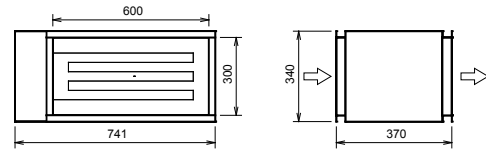

WATER HEATING COIL

Water heating coil		Supply
Heating medium		Water
Air volume	m ³ /h / l/s	3000 / 833
Temperature at inlet (after heat recovery)	°C	17
Temperature at outlet (downstream of the heater)	°C	19
Heating capacity	kW	2.6
Heating medium temperature drop	°C	70/50
Medium flow (from source)	l/h	111
Connection dimension (hydraulic kit)		1" female

Note: The figures above have been measured at 3000 m³/h and 200 Pa. Please use the Duplexvent Selection Software to calculate measurements at other performance levels.

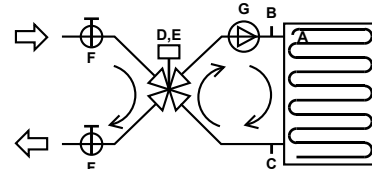

- A Freeze protection thermostat 016-H6929-109-6m 2)
 - B Air vent automatic 2)
 - C Sludge valve plug 2)
 - Hydraulic kit: RE-TPO4.E.LM24A-SR
 - D Mixing valve IVAR.MIX4, Kv 12, 1" 1)
 - E Actuator LM24A-SR 1)
 - F Globe valve 1" 1)
 - G Pump WILO YONOS PARA RS 20/6- RKC 1)
- 1 - delivered separately
2 - fitted and connected

HEATING CAPACITY

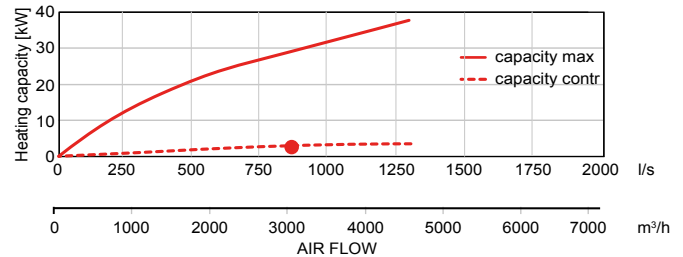

WATER COOLING COIL

Water cooling coil		Supply
Cooling medium		21% Ethylene glycol
Air volume	m ³ /h / l/s	3000 / 833
Temperature at inlet (after heat recovery)	°C	27
Temperature at outlet (downstream of the cooling coil)	°C	16
Inlet relative humidity (after heat recovery)	% RH	53
Outlet relative humidity (downstream of the cooling coil)	% RH	89
Cooling capacity	kW	15.8
Condensate production	l/h	7
Water temperature drop	°C	6 / 12
Medium flow (at max. capacity)	l/h	2600
Medium-side pressure drop		
in heat exchanger	kPa	20.14
in valve	kPa	6.62
Connection dimension		1" female

Note: The figures above have been measured at 3000 m³/h and 200 Pa. Please use the Duplexvent Selection Software to calculate measurements at other performance levels.

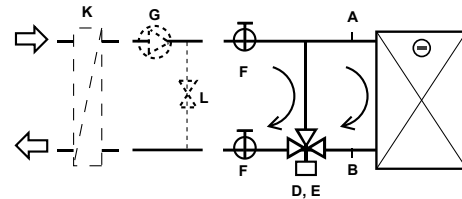

- A Air vent automatic 2)
 - B Sludge valve plug 2)
 - Hydraulic kit: R-CHW3.E.TR 24-SR
 - D 3-way ball valve R3020-B1 1)
 - E Actuator TR 24-SR 1)
 - F Globe valve 1" 1)
 - Others:
 - G Pump 3)
 - L Water bypass 3)
 - K Coil water/ethylene glycol 3)
- 1 - Delivered separately
2 - Fitted and connected
3 - Not part of delivery

COOLING CAPACITY

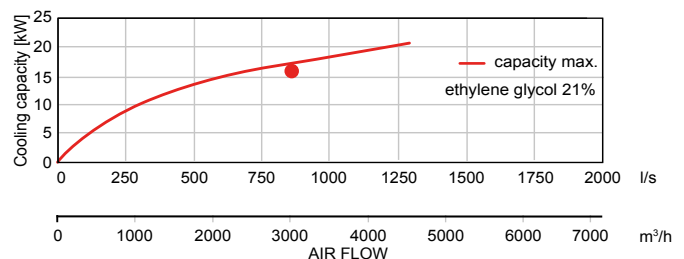

DX COIL

DX coil		Supply
Air volume	m ³ /h / l/s	3000 / 833
Temperature at inlet (after heat recovery)	°C	27
Temperature at outlet (downstream of the DX coil)	°C	17
Inlet relative humidity (after heat recovery)	% RH	53
Outlet relative humidity (downstream of the DX coil)	% RH	79
Cooling capacity	kW	15.8
Condensate production	l/h	9
Refrigerant type		R410A
Evaporating temperature	°C	4

Note: The figures above have been measured at 3000 m³/h and 200 Pa. Please use the Duplexvent Selection Software to calculate measurements at other performance levels.

COOLING CAPACITY

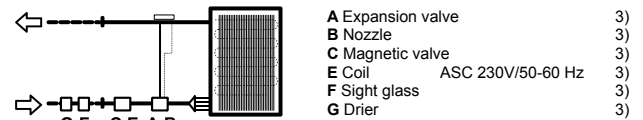
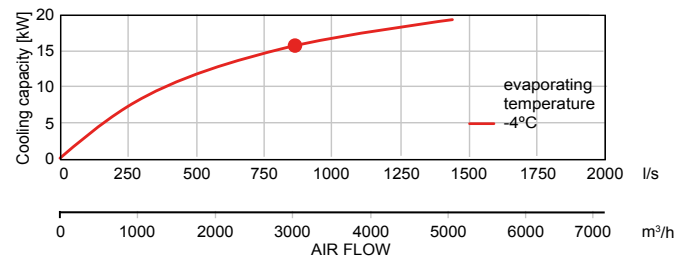

3 Not part of delivery, recommended type mentioned

DIMENSIONS

Position **50/0** upright
front view (from the door side)

Weight: approx. **485 kg**

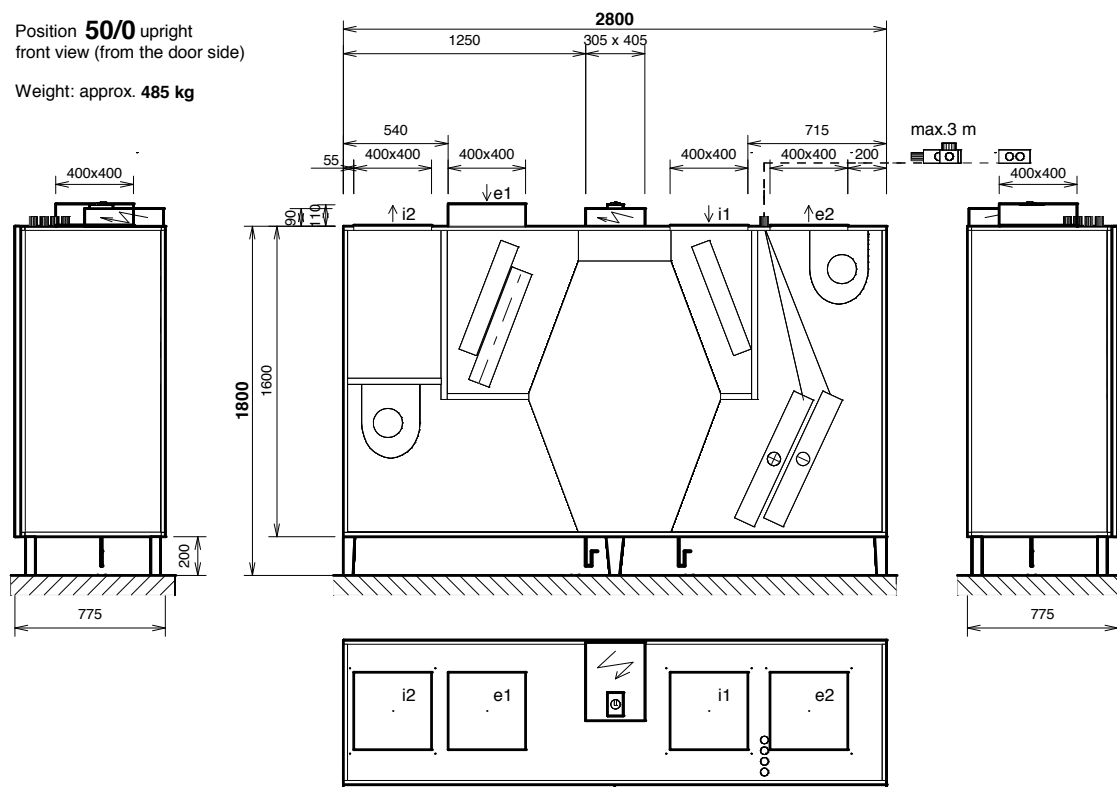

Connections	Type	Dimensions	Optional components
e1	e1- outdoor air (ODA)	400x400mm	Shutoff damper, flexible connection
e2	e2- supply air (SUP)	400x400mm	Flexible connection
i1	i1- extract air (ETA)	400x400mm	Shutoff damper, flexible connection
i2	i2- exhaust air (EHA)	400x400mm	Flexible connection
K	condensate drain	2x Ø 32 mm/40 mm	Condensate pump

Notice:

- Unit supplied as one piece
- Door - 2 parts
- Diagram is intended only for basic information, binding dimensions receive at device delivery, or on request from the manufacturer.
- bolt holes for duct connection (for one port): 4 x M6

Duplexvent Multi eco-V DV4500

Commercial MVHR with cross-counter-flow heat exchanger - Indoor



KEY FEATURES

- Air volume up to 3500 m³/h at 200 Pa according to ErP 2018
- Digital Touchscreen or simple manual controller
- Low noise, refer to NR35 and BB93 standards
- Excellent thermal insulation (class T2, TB1)
- Filters: ePM2,5 65 % (F7), ePM10 70 % (M5) or Coarse 60 % (G4)
- Optional circulation damper
- Optional constant flow and constant pressure mode
- BREEAM and ErP 2018 compliant
- Meets Building Regulations Part L2A and L2B

PERFORMANCE

Ventilation		Supply Air	Extract Air
Air volume @ 400 Pa	m ³ /h / l/s	3500 / 972	3500 / 972
Nominal voltage	V	400	400
Nominal power (at operation point)	kW	0.7	0.9
Fan Speed	min ⁻¹	2053	2188
Max power input	kW	2.5	2.5
Max current	A	3.8	3.8
Fan Type		EC	EC

Note: The figures above have been measured at 3500 m³/h and 200 Pa. Please use the Duplexvent Selection Software to calculate measurements at other performance levels.

AIR FLOW CURVE

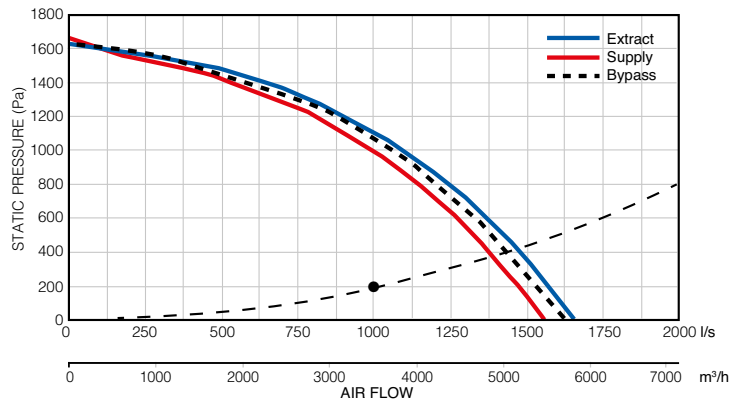

Heat Recovery		Supply Air	Extract Air
Air volume @ 200 Pa	m ³ /h / l/s	3500 / 972	3500 / 972
Temperature at inlet	°C	-5	20
Temperature at outlet	°C	17.5	2.5
Humidity at inlet	% RH	90	40
Humidity at outlet	% RH	18	96
Heat recovery efficiency winter / summer	%	88 / 83	
Performance in winter / summer	kW	26.7 / 6.1	
Condensation	l/h	6.4	
Type of heat exchanger		Cross-counter-flow, Plastic	
Part No.		90000804	

Note: The figures above have been measured at 3500 m³/h and 200 Pa. Please use the Duplexvent Selection Software to calculate measurements at other performance levels.

POWER CONSUMPTION

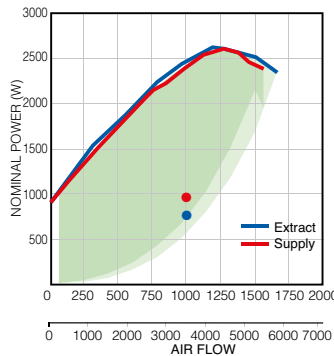

Note: Green area denotes power consumption range. Power consumption depends on system installation.

HEAT RECOVERY EFFICIENCY

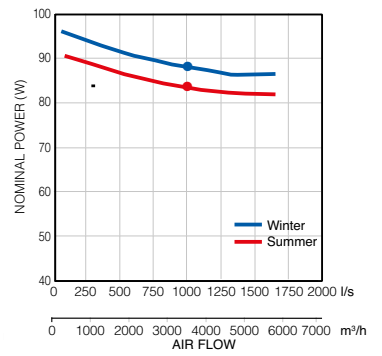

Sound Power Level L _w	Total	63 Hz	125 Hz	250 Hz	500 Hz	1 kHz	2 kHz	4 kHz	8 kHz
	dB (A)								
Outdoor air e1	64	45	52	61	59	54	44	41	29
Supply air e2	88	64	71	80	84	82	75	68	58
Extract air i1	63	41	49	56	61	49	39	28	<25
Exhaust air i2	84	60	67	75	81	79	72	65	57
Breakout noise	65	36	44	62	60	56	54	48	38
Sound Pressure Level L_p measured at 3m	45	<25	<25	42	39	36	33	27	<25

Note: The figures above have been measured at 3500 m³/h and 200 Pa. Please use the Duplexvent Selection Software to calculate measurements at other performance levels.

Winter Operation:

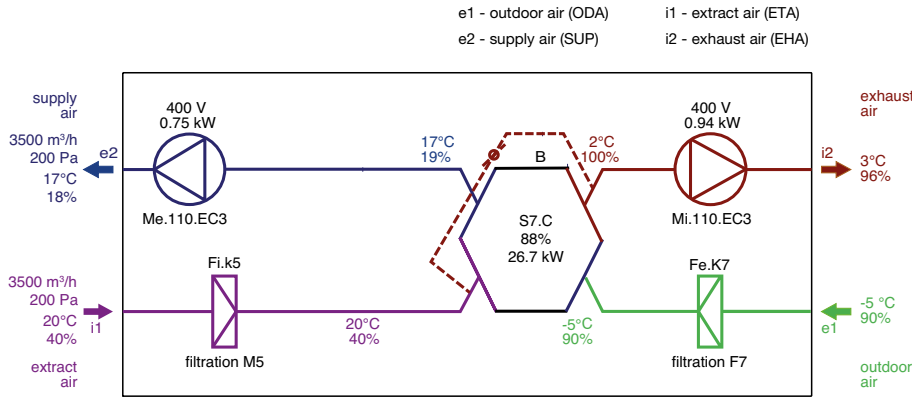

Note: AHU functions diagram. Inlet and outlet location may differ from actual position and port configuration.

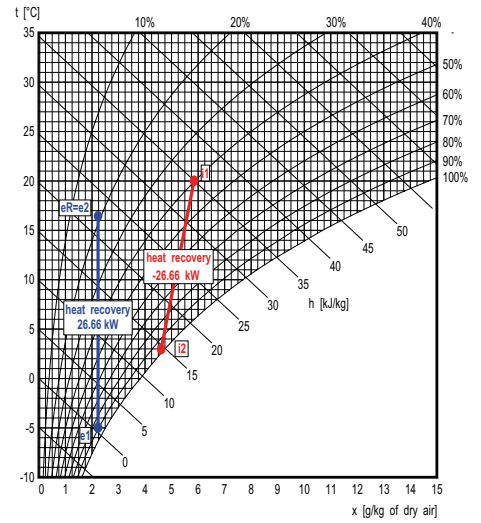

Supply

Description	t [°C]	RH [%]
e1 Outdoor Air	-5.0	90
e2 Supply Air	17.5	18

Exhaust

Description	t [°C]	RH [%]
i1 Extract Air	20.0	40
i2 Exhaust Air	2.5	96

Summer Operation:

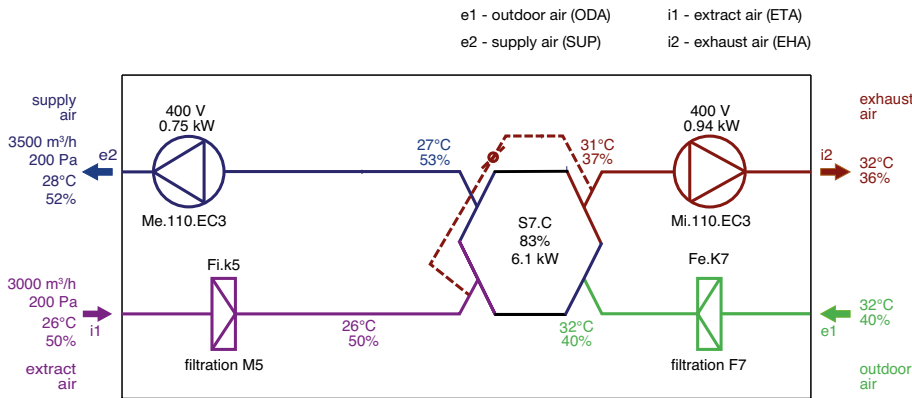

Note: AHU functions diagram. Inlet and outlet location may differ from actual position and port configuration.

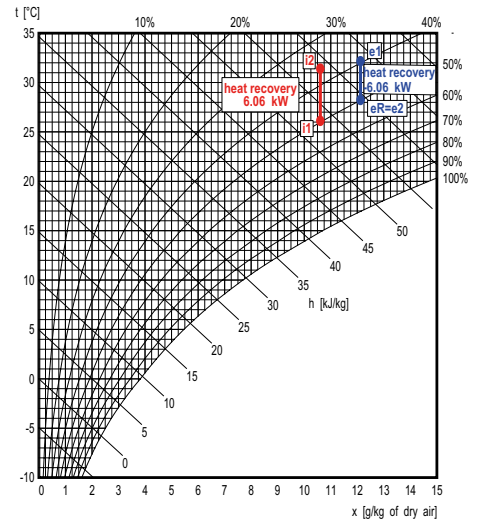

Supply

Description	t [°C]	RH [%]
e1 Outdoor Air	32.0	40
e2 Supply Air	27.6	52

Exhaust

Description	t [°C]	RH [%]
i1 Extract Air	26.0	50
i2 Exhaust Air	31.6	36

FILTERS

Filtration	Supply	Extract	Accessories (part of delivery)
Type	Pleated Cartridge		Pfe dirty filter pressure switch for supply air Pfi dirty filter pressure switch for extract air
Filtration class	ePM2,5 65 % (F7)	ePM10 70 % (M5)	
Number of filters	2	2	
Filter cartridge size	750x405x96	750x405x96	

Duplexvent Multi eco-V DV4500

Commercial MVHR with cross-counter-flow heat exchanger - Indoor

OPTIONAL ACCESSORIES

ELECTRIC PRE-HEATER

Electric pre-heater	Supply	
Air volume	m ³ /h / l/s	3500 / 972
Maximum heating capacity	kW	15.0
Voltage	V	400
Connection ports	mm	300x300

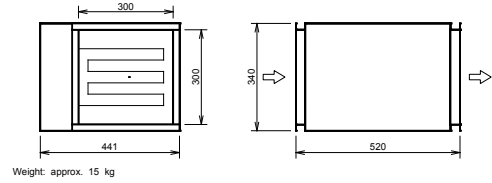

WATER HEATING COIL

Water heating coil	Supply	
Heating medium	Water	
Air volume	m ³ /h / l/s	3500 / 972
Temperature at inlet (after heat recovery)	°C	17
Temperature at outlet (downstream of the heater)	°C	19
Heating capacity	kW	2.8
Heating medium temperature drop	°C	70/50
Medium flow (from source)	l/h	119
Connection dimension (hydraulic kit)	1" female	

Note: The figures above have been measured at 3500 m³/h and 200 Pa. Please use the Duplexvent Selection Software to calculate measurements at other performance levels.

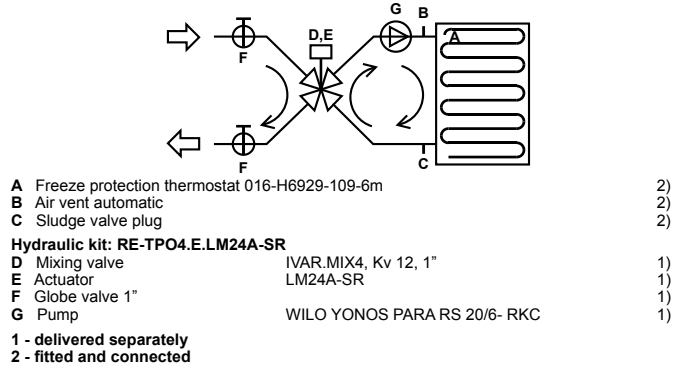

HEATING CAPACITY

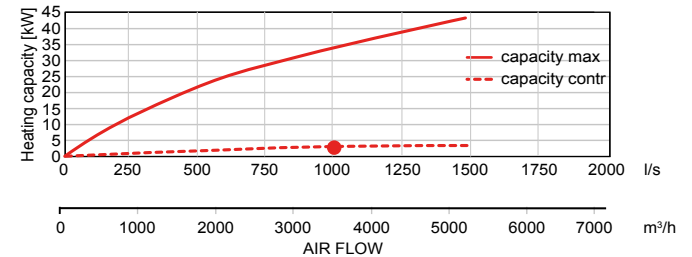

WATER COOLING COIL

Water cooling coil	Supply	
Cooling medium	21% Ethylene glycol	
Air volume	m ³ /h / l/s	3500 / 972
Temperature at inlet (after heat recovery)	°C	27
Temperature at outlet (downstream of the cooling coil)	°C	16
Inlet relative humidity (after heat recovery)	% RH	53
Outlet relative humidity (downstream of the cooling coil)	% RH	86
Cooling capacity	kW	18.9
Condensate production	l/h	9
Water temperature drop	°C	6 / 12
Medium flow (at max. capacity)	l/h	3300
Medium-side pressure drop		
in heat exchanger	kPa	20.93
in valve	kPa	10.66
Connection dimension	1" female	

Note: The figures above have been measured at 3500 m³/h and 200 Pa. Please use the Duplexvent Selection Software to calculate measurements at other performance levels.

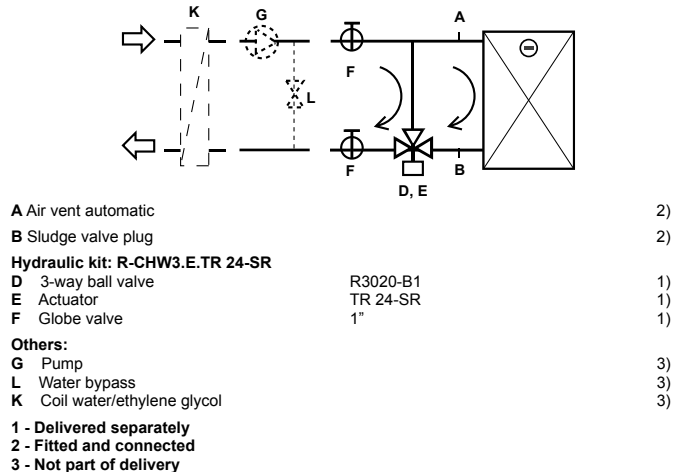

COOLING CAPACITY

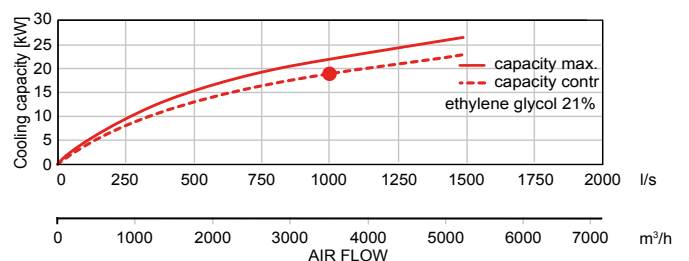

DX COIL

DX coil		Supply
Air volume	m ³ /h / l/s	3500 / 972
Temperature at inlet (after heat recovery)	°C	27
Temperature at outlet (downstream of the DX coil)	°C	17
Inlet relative humidity (after heat recovery)	% RH	53
Outlet relative humidity (downstream of the DX coil)	% RH	79
Cooling capacity	kW	15.8
Condensate production	l/h	12
Refrigerant type		R410A
Evaporating temperature	°C	11

Note: The figures above have been measured at 3500 m³/h and 200 Pa. Please use the Duplexvent Selection Software to calculate measurements at other performance levels.

COOLING CAPACITY

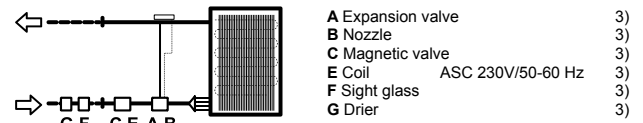
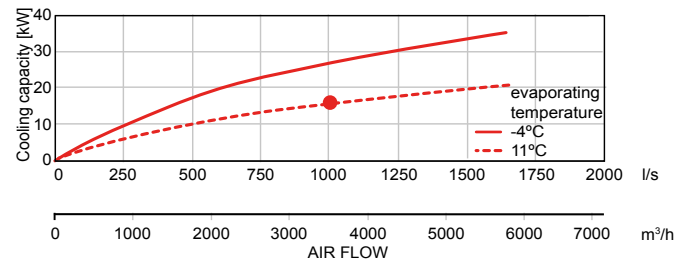

3 Not part of delivery, recommended type mentioned

DIMENSIONS

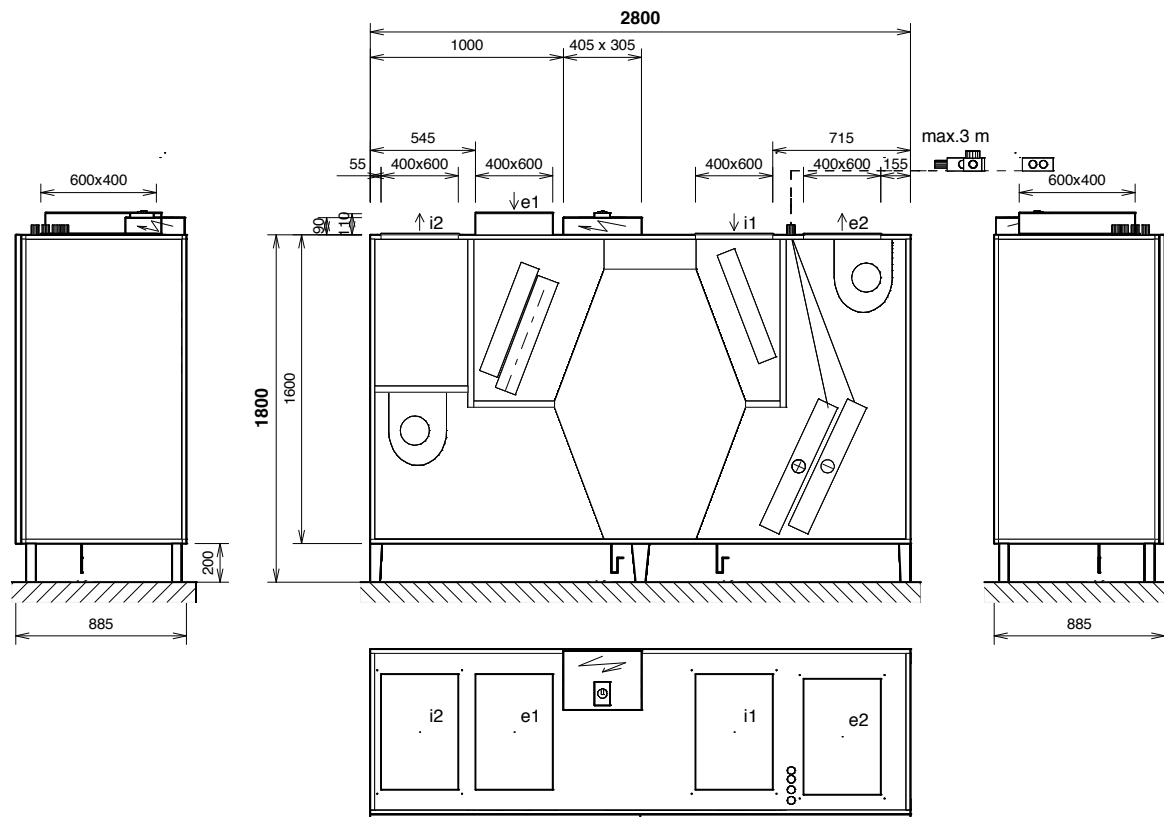

Connections	Type	Dimensions	Optional components
e1	e1- outdoor air (ODA)	400x600mm	Shutoff damper
e2	e2- supply air (SUP)	400x600mm	4 x M6 Thread for 20mm flange
i1	i1- extract air (ETA)	400x600mm	4 x M6 Thread for 20mm flange
i2	i2- exhaust air (EHA)	400x600mm	4 x M6 Thread for 20mm flange
K	condensate drain	2x Ø 32 mm/40 mm	Trap

Notice:

- Unit supplied as one piece
- Door – 2 parts
- Diagram is intended only for basic information, binding dimensions receive at device delivery, or on request from the manufacturer.
- bolt holes for duct connection (for one port): 4 x M6

Duplexvent Multi eco-V DV5500

Commercial MVHR with cross-counter-flow heat exchanger - Indoor



KEY FEATURES

- Air volume up to 4500 m³/h at 300 Pa according to ErP 2018
- Digital Touchscreen or simple manual controller
- Low noise, refer to NR35 and BB93 standards
- Excellent thermal insulation (class T2, TB1)
- Filters: ePM2,5 65 % (F7), ePM10 70 % (M5) or Coarse 60 % (G4)
- Optional circulation damper
- Optional constant flow and constant pressure mode
- BREEAM and ErP 2018 compliant
- Meets Building Regulations Part L2A and L2B

PERFORMANCE

Ventilation		Supply Air	Extract Air
Air volume @ 400 Pa	m ³ /h / l/s	4500 / 1250	4500 / 1250
Nominal voltage	V	400	400
Nominal power (at operation point)	kW	1.3	1.3
Fan Speed	min ⁻¹	2003	2027
Max power input	kW	3.3	3.3
Max current	A	5.4	5.4
Fan Type		EC	EC

Note: The figures above have been measured at 4500 m³/h and 300 Pa. Please use the Duplexvent Selection Software to calculate measurements at other performance levels.

AIR FLOW CURVE

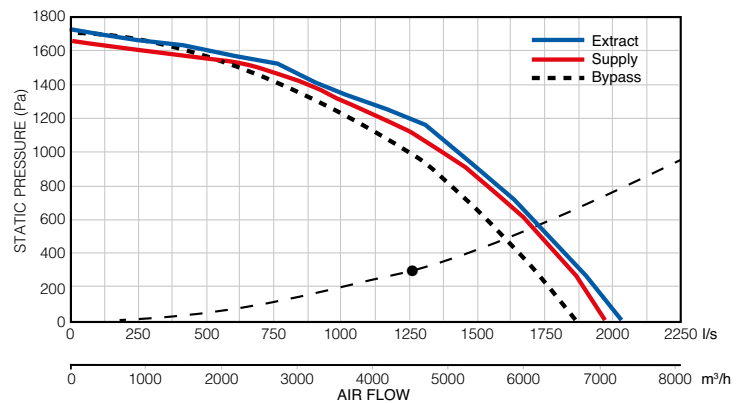

Heat Recovery		Supply Air	Extract Air
Air volume @ 200 Pa	m ³ /h / l/s	4500 / 1250	4500 / 1250
Temperature at inlet	°C	-5	20
Temperature at outlet	°C	17.4	2.7
Humidity at inlet	% RH	90	40
Humidity at outlet	% RH	18	96
Heat recovery efficiency winter / summer	%	87 / 82	
Performance in winter / summer	kW	33.9 / 7.7	
Condensation	l/h	7.9	
Type of heat exchanger		Cross-counter-flow, Plastic	
Part No.		90000805	

Note: The figures above have been measured at 4500 m³/h and 300 Pa. Please use the Duplexvent Selection Software to calculate measurements at other performance levels.

POWER CONSUMPTION

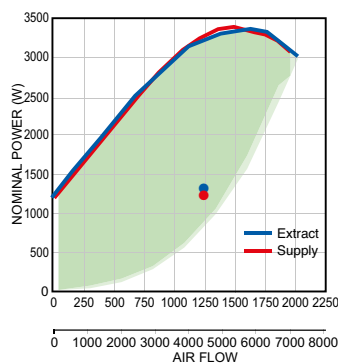

Note: Green area denotes power consumption range. Power consumption depends on system installation.

HEAT RECOVERY EFFICIENCY

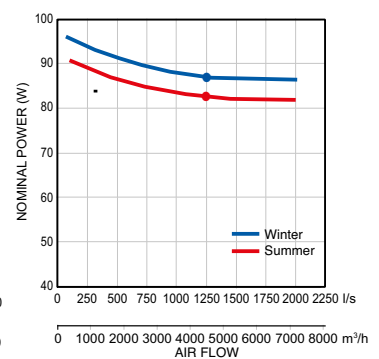

Sound Power Level L _w	Total	63 Hz	125 Hz	250 Hz	500 Hz	1 kHz	2 kHz	4 kHz	8 kHz
	dB (A)								
Outdoor air e1	66	49	54	63	62	55	46	39	33
Supply air e2	93	72	78	84	90	86	79	71	62
Extract air i1	69	46	54	64	67	55	43	30	<25
Exhaust air i2	91	71	78	84	88	85	78	71	61
Breakout noise	68	45	48	65	61	59	50	46	35
Sound Pressure Level L _p measured at 3m	47	<25	27	45	40	38	30	26	<25

Note: The figures above have been measured at 4500 m³/h and 300 Pa. Please use the Duplexvent Selection Software to calculate measurements at other performance levels.

Winter Operation:

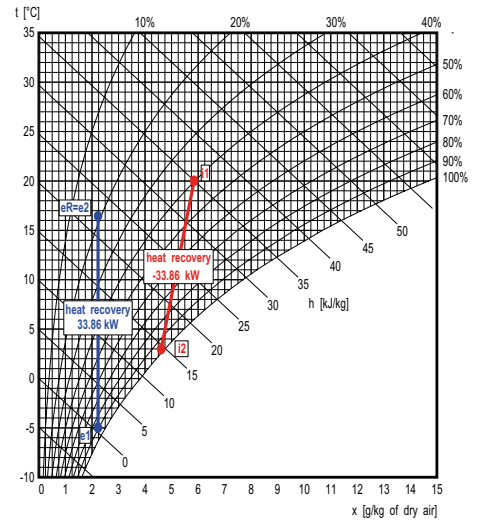
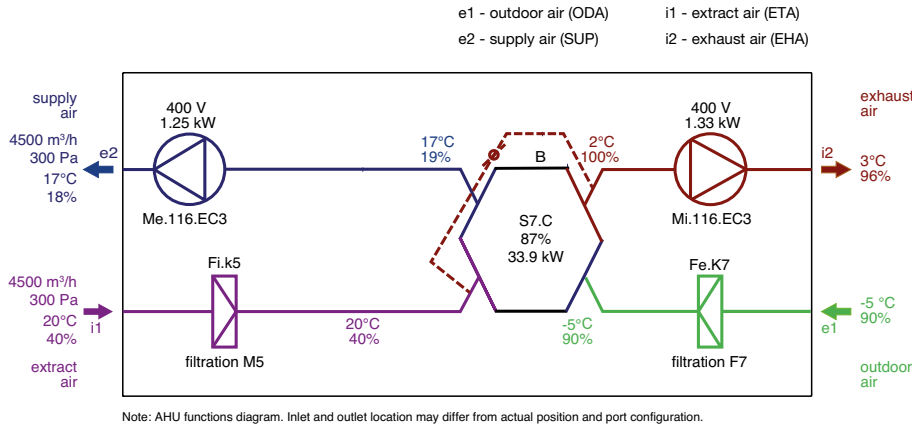

Supply

Description	t [°C]	RH [%]
e1 Outdoor Air	-5.0	90
e2 Supply Air	17.4	18

Exhaust

Description	t [°C]	RH [%]
i1 Extract Air	20.0	40
i2 Exhaust Air	2.7	96

Summer Operation:

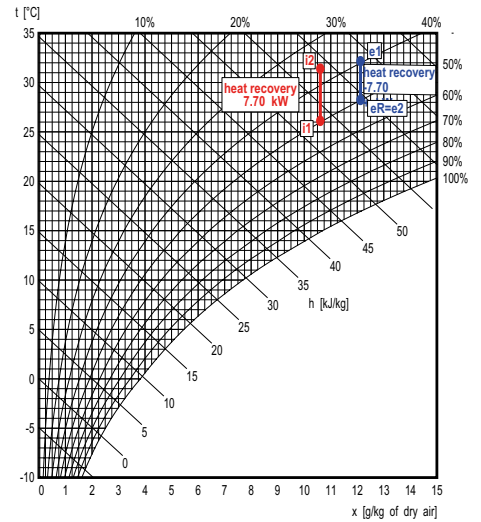
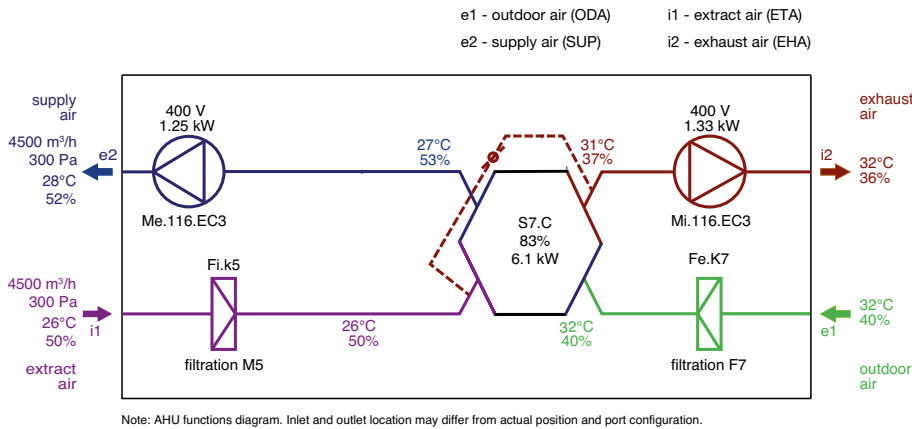

Supply

Description	t [°C]	RH [%]
e1 Outdoor Air	32.0	40
e2 Supply Air	27.8	51

Exhaust

Description	t [°C]	RH [%]
i1 Extract Air	26.0	50
i2 Exhaust Air	31.6	36

FILTERS

Filtration Type	Supply	Extract	Accessories (part of delivery)
	Pleated Cartridge		
Filtration class	ePM2,5 65 % (F7)	ePM10 70 % (M5)	Pfe dirty filter pressure switch for supply air
Number of filters	2	2	Pfi dirty filter pressure switch for extract air
Filter cartridge size	750x495x96	750x495x96	

Duplexvent Multi eco-V DV5500

Commercial MVHR with cross-counter-flow heat exchanger - Indoor

OPTIONAL ACCESSORIES

ELECTRIC PRE-HEATER

Electric pre-heater		Supply
Air volume	m ³ /h / l/s	4500 / 1250
Maximum heating capacity	kW	24.0
Voltage	V	400
Connection ports	mm	300x500

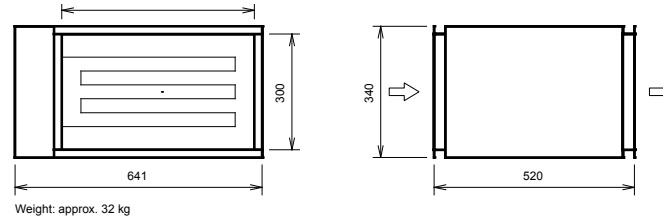

WATER HEATING COIL

Water heating coil		Supply
Heating medium		Water
Air volume	m ³ /h / l/s	4500 / 1250
Temperature at inlet (after heat recovery)	°C	17
Temperature at outlet (downstream of the heater)	°C	19
Heating capacity	kW	3.8
Heating medium temperature drop	°C	70/50
Medium flow (from source)	l/h	165
Connection dimension (hydraulic kit)		1" female

Note: The figures above have been measured at 4500 m³/h and 300 Pa. Please use the Duplexvent Selection Software to calculate measurements at other performance levels.

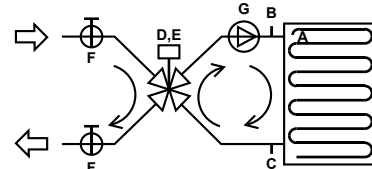

- A Freeze protection thermostat 016-H6929-109-6m 2)
 - B Air vent automatic 2)
 - C Sludge valve plug 2)
 - Hydraulic kit: RE-TPO4.E.LM24A-SR
 - D Mixing valve IVAR.MIX4, Kv 12, 1" 1)
 - E Actuator LM24A-SR 1)
 - F Globe valve 1" 1)
 - G Pump WILO YONOS PARA RS 20/6- RKC 1)
- 1 - delivered separately
2 - fitted and connected

HEATING CAPACITY

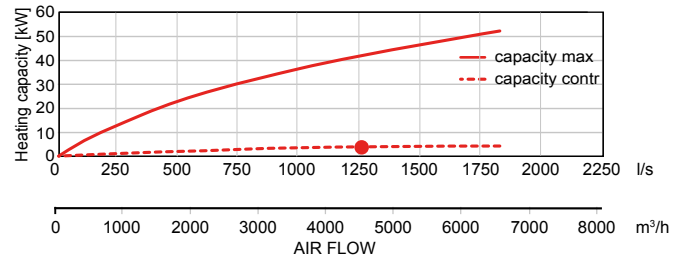

WATER COOLING COIL

Water cooling coil		Supply
Cooling medium		21% Ethylene glycol
Air volume	m ³ /h / l/s	4500 / 1250
Temperature at inlet (after heat recovery)	°C	27
Temperature at outlet (downstream of the cooling coil)	°C	16
Inlet relative humidity (after heat recovery)	% RH	53
Outlet relative humidity (downstream of the cooling coil)	% RH	87
Cooling capacity	kW	23.9
Condensate production	l/h	11
Water temperature drop	°C	6 / 12
Medium flow (at max. capacity)	l/h	4010
Medium-side pressure drop		
in heat exchanger	kPa	16.49
in valve	kPa	15.72
Connection dimension		1" female

Note: The figures above have been measured at 4500 m³/h and 300 Pa. Please use the Duplexvent Selection Software to calculate measurements at other performance levels.

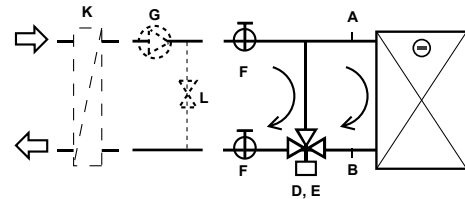

- A Air vent automatic 2)
 - B Sludge valve plug 2)
 - Hydraulic kit: R-CHW3.E.TR 24-SR
 - D 3-way ball valve R3020-B1 1)
 - E Actuator TR 24-SR 1)
 - F Globe valve 1" 1)
 - Others:
 - G Pump 3)
 - L Water bypass 3)
 - K Coil water/ethylene glycol 3)
- 1 - Delivered separately
2 - Fitted and connected
3 - Not part of delivery

COOLING CAPACITY

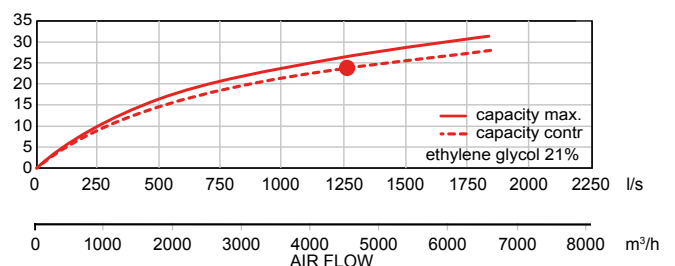

DX COIL

DX coil		Supply
Air volume	m ³ /h / l/s	4500 / 1250
Temperature at inlet (after heat recovery)	°C	27
Temperature at outlet (downstream of the DX coil)	°C	16
Inlet relative humidity (after heat recovery)	% RH	53
Outlet relative humidity (downstream of the DX coil)	% RH	82
Cooling capacity	kW	21.3
Condensate production	l/h	15
Refrigerant type		R410A
Evaporating temperature	°C	10

Note: The figures above have been measured at 4500 m³/h and 300 Pa. Please use the Duplexvent Selection Software to calculate measurements at other performance levels.

COOLING CAPACITY

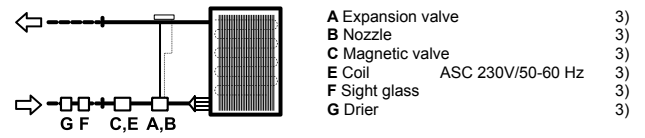
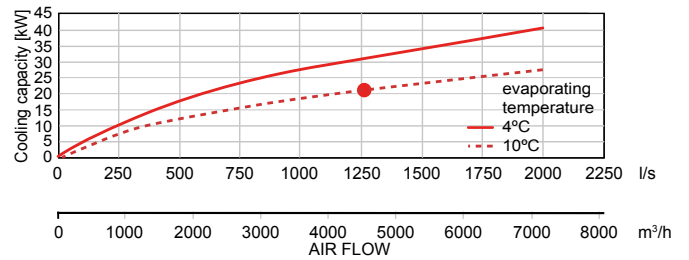

3 Not part of delivery, recommended type mentioned

DIMENSIONS

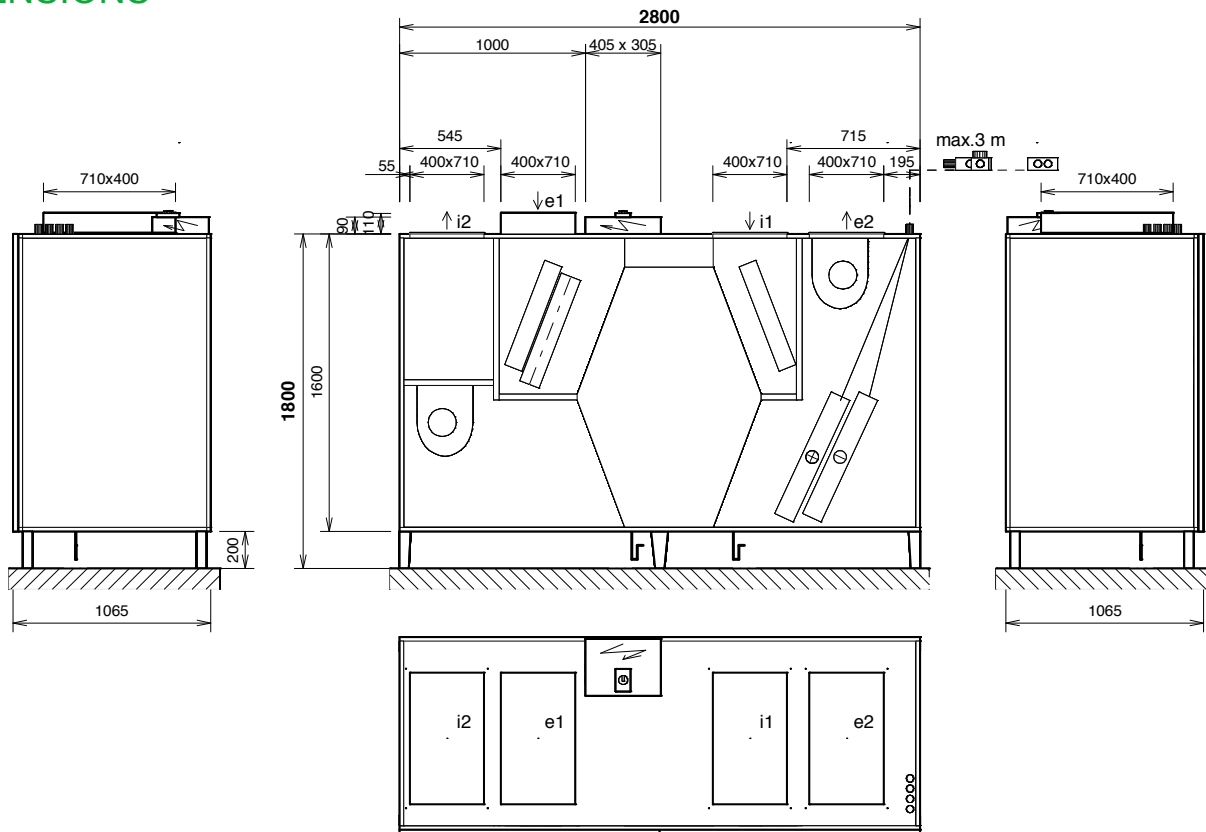

Connections	Type	Dimensions	Optional components
e1	e1- outdoor air (ODA)	400x710mm	Shutoff damper
e2	e2- supply air (SUP)	400x710mm	4 x M6 Thread for 20mm flange
i1	i1- extract air (ETA)	400x710mm	4 x M6 Thread for 20mm flange
i2	i2- exhaust air (EHA)	400x710mm	4 x M6 Thread for 20mm flange
K	condensate drain	2x Ø 32 mm/40 mm	Trap

Notice:

- Unit supplied as one piece
- Door – 2 parts
- Diagram is intended only for basic information, binding dimensions receive at device delivery, or on request from the manufacturer.
- bolt holes for duct connection (for one port): 4 x M6

Duplexvent Multi eco-V DV6500

Commercial MVHR with cross-counter-flow heat exchanger - Indoor



KEY FEATURES

- Air volume up to 5500 m³/h at 300 Pa according to ErP 2018
- Digital Touchscreen or simple manual controller
- Low noise, refer to NR35 and BB93 standards
- Excellent thermal insulation (class T2, TB1)
- Filters: ePM2,5 65 % (F7), ePM10 70 % (M5) or Coarse 60 % (G4)
- Optional circulation damper
- Optional constant flow and constant pressure mode
- BREEAM and ErP 2018 compliant
- Meets Building Regulations Part L2A and L2B

PERFORMANCE

Ventilation		Supply Air	Extract Air
Air volume @ 400 Pa	m ³ /h / l/s	5500 / 1528	5500 / 1528
Nominal voltage	V	400	400
Nominal power (at operation point)	kW	1.7	1.5
Fan Speed	min ⁻¹	2202	2155
Max power input	kW	3.3	3.3
Max current	A	5.4	5.4
Fan Type		EC	EC

Note: The figures above have been measured at 5500 m³/h and 300 Pa. Please use the Duplexvent Selection Software to calculate measurements at other performance levels.

AIR FLOW CURVE

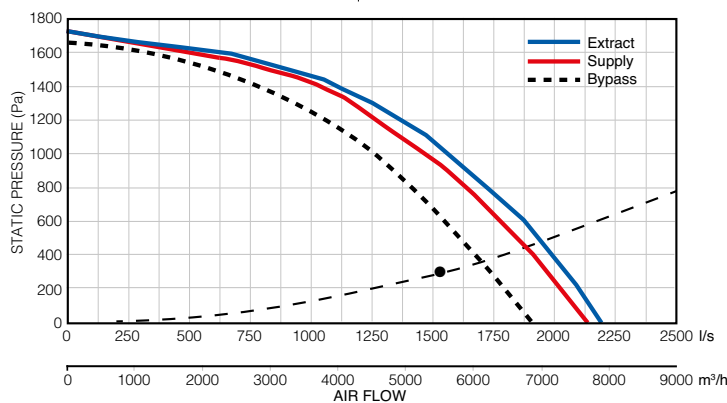

Heat Recovery		Supply Air	Extract Air
Air volume @ 200 Pa	m ³ /h / l/s	5500 / 1528	5500 / 1528
Temperature at inlet	°C	-5	20
Temperature at outlet	°C	17.4	2.7
Humidity at inlet	% RH	90	40
Humidity at outlet	% RH	18	96
Heat recovery efficiency winter / summer	%	87 / 82	
Performance in winter / summer	kW	41.4 / 9.4	
Condensation	l/h	9.7	
Type of heat exchanger		Cross-counter-flow, Plastic	
Part No.		90000806	

Note: The figures above have been measured at 5500 m³/h and 300 Pa. Please use the Duplexvent Selection Software to calculate measurements at other performance levels.

POWER CONSUMPTION

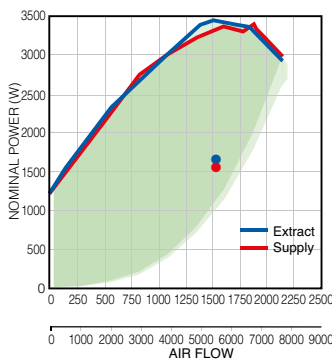

Note: Green area denotes power consumption range. Power consumption depends on system installation.

HEAT RECOVERY EFFICIENCY

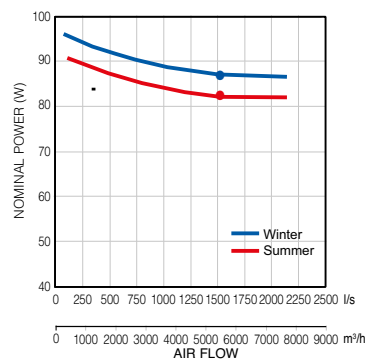

Sound Power Level L _w	Total	63 Hz	125 Hz	250 Hz	500 Hz	1 kHz	2 kHz	4 kHz	8 kHz
	dB (A)								
Outdoor air e1	70	49	57	66	66	61	49	41	33
Supply air e2	93	70	77	84	89	88	81	73	63
Extract air i1	73	52	61	69	70	63	51	34	<25
Exhaust air i2	86	60	67	76	82	82	75	68	62
Breakout noise	79	56	61	74	73	71	70	66	54
Sound Pressure Level L _p measured at 3m	58	35	41	53	52	51	50	46	33

Note: The figures above have been measured at 5500 m³/h and 300 Pa. Please use the Duplexvent Selection Software to calculate measurements at other performance levels.

Winter Operation:

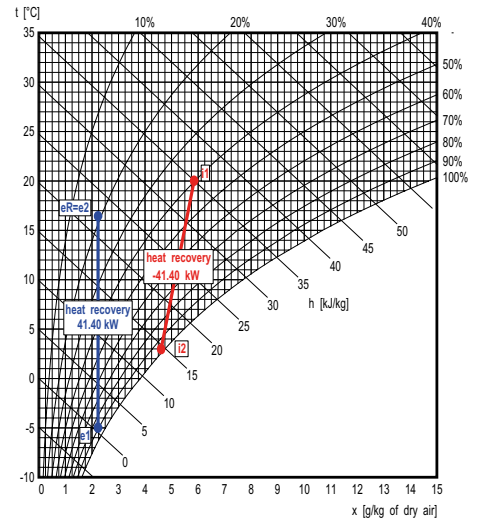
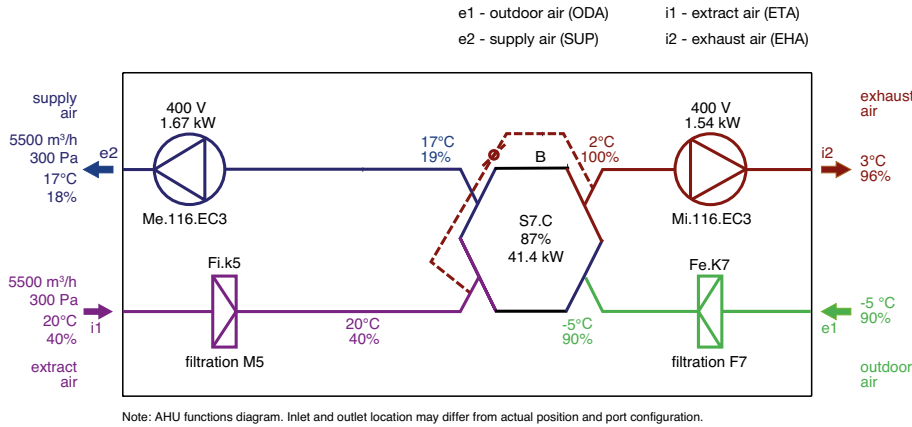

Supply

Description	t [°C]	RH [%]
e1 Outdoor Air	-5.0	90
e2 Supply Air	17.4	18

Exhaust

Description	t [°C]	RH [%]
i1 Extract Air	20.0	40
i2 Exhaust Air	2.7	96

Summer Operation:

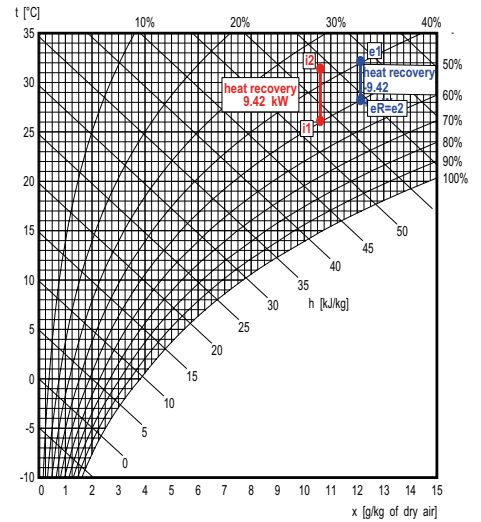
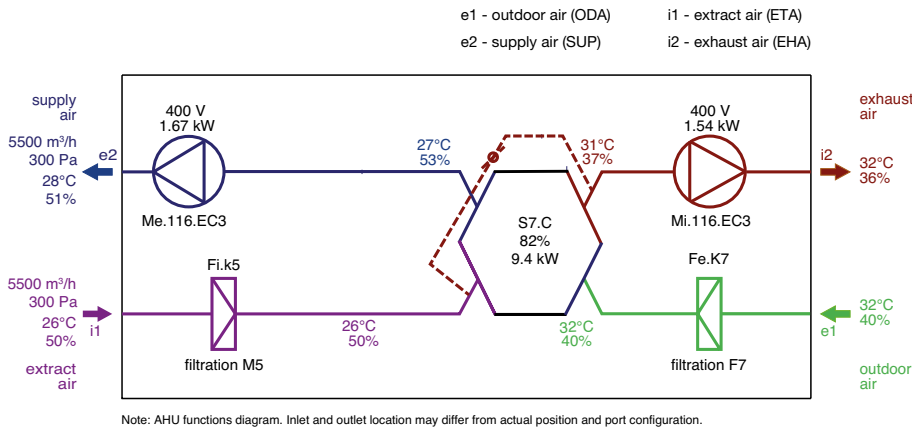

Supply

Description	t [°C]	RH [%]
e1 Outdoor Air	32.0	40
e2 Supply Air	27.8	51

Exhaust

Description	t [°C]	RH [%]
i1 Extract Air	26.0	50
i2 Exhaust Air	31.6	36

FILTERS

Filtration Type	Supply	Extract	Accessories (part of delivery)
	Pleated Cartridge		
Filtration class	ePM2,5 65 % (F7)	ePM10 70 % (M5)	Pfe dirty filter pressure switch for supply air
Number of filters	3	3	Pfi dirty filter pressure switch for extract air
Filter cartridge size	750x405x96	750x405x96	

Duplexvent Multi eco-V DV6500

Commercial MVHR with cross-counter-flow heat exchanger - Indoor

OPTIONAL ACCESSORIES

ELECTRIC PRE-HEATER

Electric pre-heater		Supply
Air volume	m ³ /h / l/s	5500 / 1528
Maximum heating capacity	kW	54.0
Voltage	V	400
Connection ports	mm	500x800

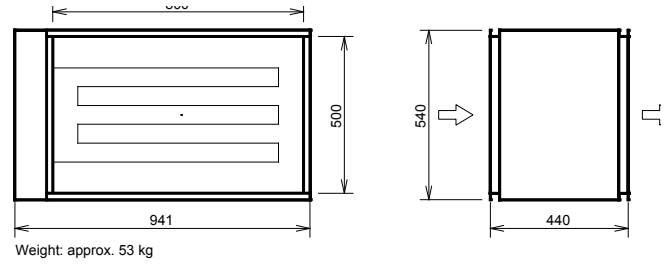

WATER HEATING COIL

Water heating coil		Supply
Heating medium		Water
Air volume	m ³ /h / l/s	5500 / 1528
Temperature at inlet (after heat recovery)	°C	17
Temperature at outlet (downstream of the heater)	°C	19
Heating capacity	kW	4.7
Heating medium temperature drop	°C	70/50
Medium flow (from source)	l/h	203
Connection dimension (hydraulic kit)		1" female

Note: The figures above have been measured at 5500 m³/h and 300 Pa. Please use the Duplexvent Selection Software to calculate measurements at other performance levels.

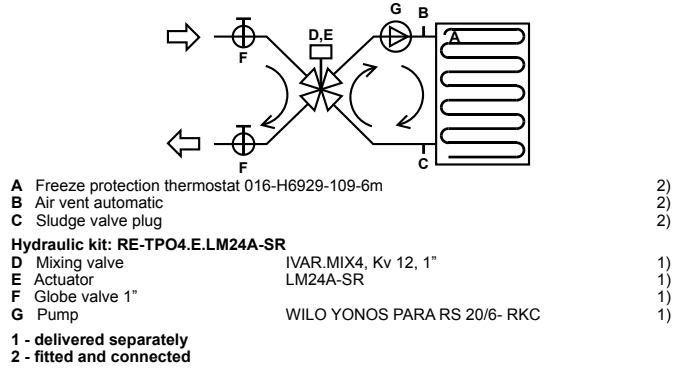

HEATING CAPACITY

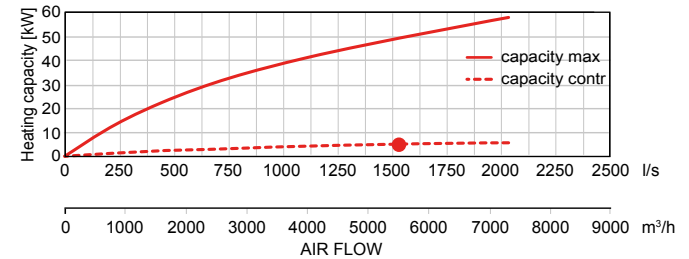

WATER COOLING COIL

Water cooling coil		Supply
Cooling medium		21% Ethylene glycol
Air volume	m ³ /h / l/s	5500 / 1528
Temperature at inlet (after heat recovery)	°C	27
Temperature at outlet (downstream of the cooling coil)	°C	17
Inlet relative humidity (after heat recovery)	% RH	53
Outlet relative humidity (downstream of the cooling coil)	% RH	94
Cooling capacity	kW	21.5
Condensate production	l/h	4
Water temperature drop	°C	6 / 12
Medium flow (at max. capacity)	l/h	3260
Medium-side pressure drop		
in heat exchanger	kPa	3.46
in valve	kPa	10.4
Connection dimension		1" female

Note: The figures above have been measured at 5500 m³/h and 300 Pa. Please use the Duplexvent Selection Software to calculate measurements at other performance levels.

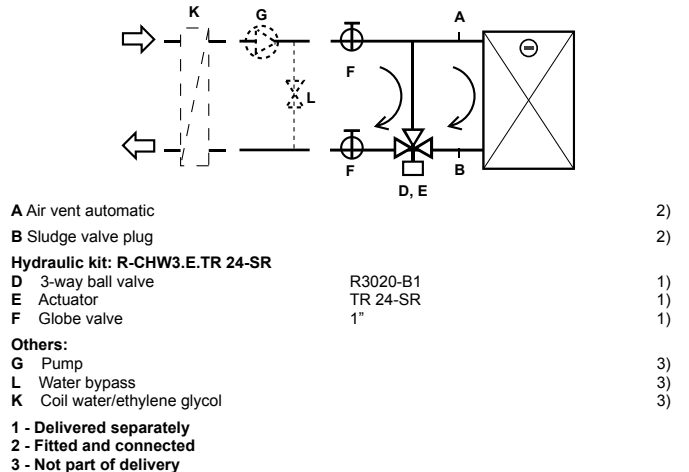

COOLING CAPACITY

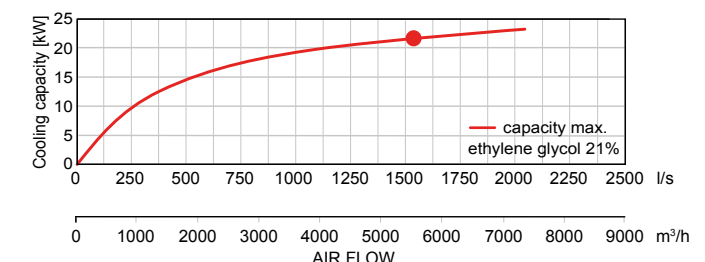

DX COIL

DX coil		Supply
Air volume	m ³ /h / l/s	5500 / 1528
Temperature at inlet (after heat recovery)	°C	27
Temperature at outlet (downstream of the DX coil)	°C	17
Inlet relative humidity (after heat recovery)	% RH	53
Outlet relative humidity (downstream of the DX coil)	% RH	79
Cooling capacity	kW	29.1
Condensate production	l/h	17
Refrigerant type		R410A
Evaporating temperature	°C	5

Note: The figures above have been measured at 5500 m³/h and 300 Pa. Please use the Duplexvent Selection Software to calculate measurements at other performance levels.

COOLING CAPACITY

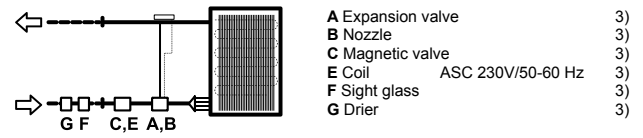
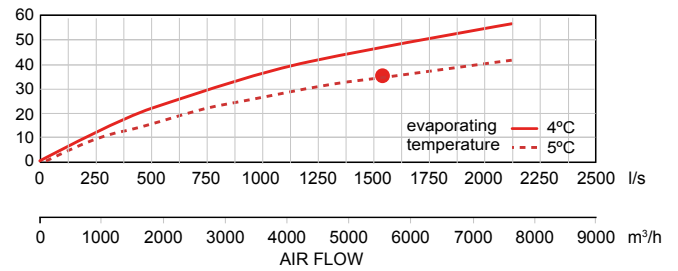

DIMENSIONS

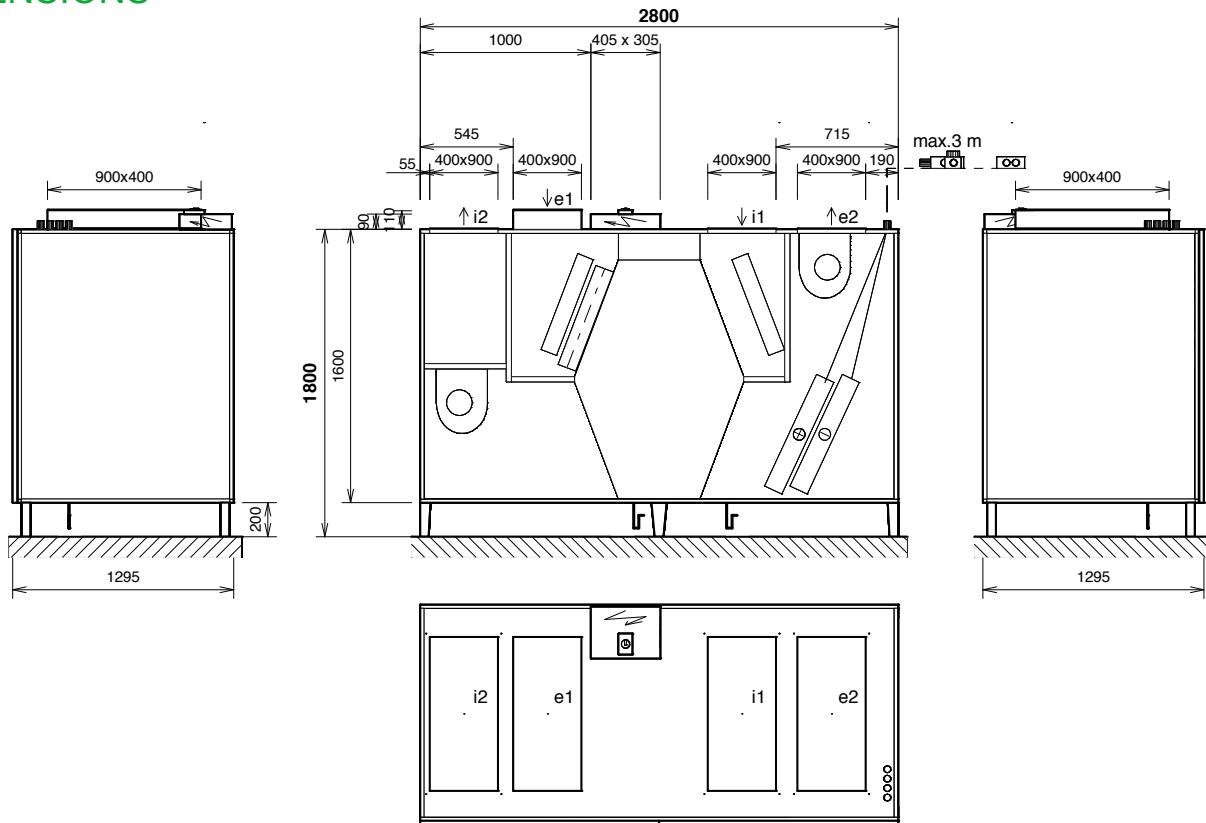

Connections	Type	Dimensions	Optional components
e1	e1- outdoor air (ODA)	400x900mm	Shutoff damper
e2	e2- supply air (SUP)	400x900mm	4 x M6 Thread for 20mm flange
i1	i1- extract air (ETA)	400x900mm	4 x M6 Thread for 20mm flange
i2	i2- exhaust air (EHA)	400x900mm	4 x M6 Thread for 20mm flange
K	condensate drain	2x Ø 32 mm/40 mm	Trap

Notice:
 - Unit supplied as one piece
 - Door – 2 parts
 - Diagram is intended only for basic information, binding dimensions receive at device delivery, or on request from the manufacturer.
 - bolt holes for duct connection (for one port): 4 x M6

Duplexvent Multi eco Roof

Heat Recovery Ventilation

LIFT INTO PLACE

Ready for crane transport – special suspension points are included as standard for easy connection to a crane.

Multi eco Roof outdoor units are designed with continuous emphasis on service comfort. The units can be maintained via side access doors, without the need to open the units doors.



OUTDOOR SIZE RANGE

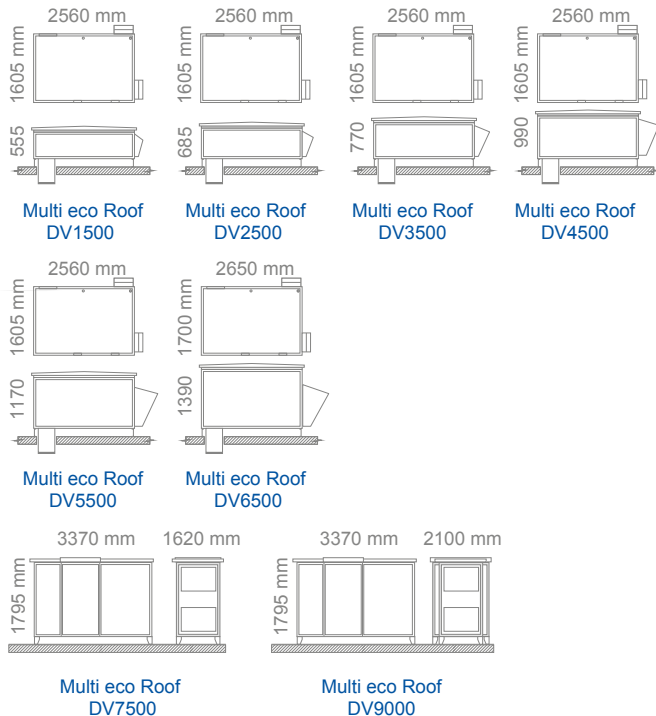

The height dimension is for units only (without the 500 mm optional base frame)

EFFICIENT INSTALLATION

Duplexvent Multi eco Roof outdoor units give the option of being installed directly on to the roof, or on a bespoke low profile, insulated base frame.

Using the stainless steel framed, highly insulated base, allows supply and extract air duct positions within the footprint of the unit. This modular, encapsulated set up reduces duct runs and does away with conventional duct insulation expense while giving a more energy efficient and easily installed unit.

Note: Bespoke insulated base frame is fitted with service access points.



COMPACT SIZE

One of the biggest Duplexvent Multi eco Roof advantages is its compact size. Having an exceptionally low height, all units up to 4000 m³/h are less than 1m high.

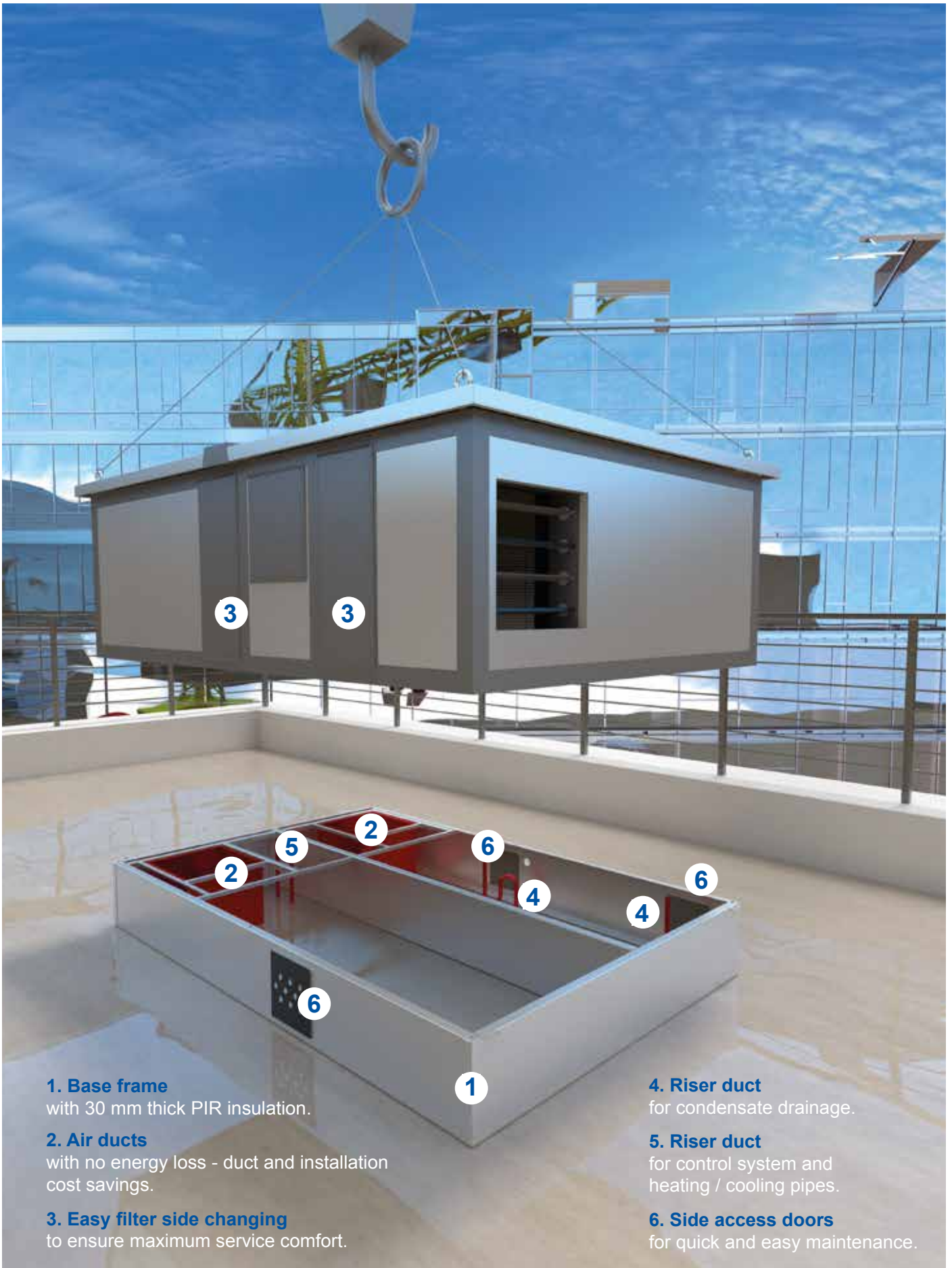

1. Base frame
with 30 mm thick PIR insulation.

2. Air ducts
with no energy loss - duct and installation cost savings.

3. Easy filter side changing
to ensure maximum service comfort.

4. Riser duct
for condensate drainage.

5. Riser duct
for control system and heating / cooling pipes.

6. Side access doors
for quick and easy maintenance.

Duplexvent Multi eco Roof

Heat Recovery Ventilation

TECHNICAL DATA

OPERATING MODES

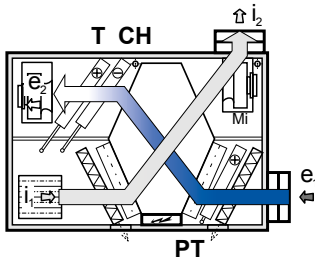

Heat recovery mode
with optional heating and cooling

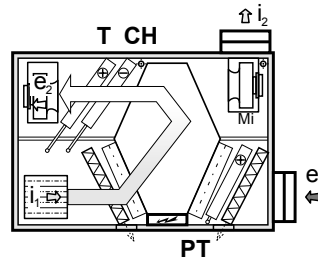

Recirculation mode
with optional heating and cooling

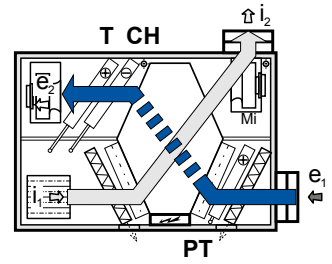

Bypass mode
(without heat recovery)

➡ e₁ ...Outdoor air (ODA)
➡ e₂ ...Supply air (SUP)

➡ i₁ ...Extract air (ETA)
➡ i₂ ...Exhaust air (EHA)

T ...Central heating connection
CH ...Cooling connection

Duplexvent Multi eco-Roof		DV1500	DV2500	DV3500	DV4500	DV5500	DV6500	DV7500	DV9000
Maximum air flow according to ErP 2018	m ³ /h / l/s	1950/542	2700/750	3100/861	4550/1264	5300/1472	5650/1569	7000/1944	8000/2222
Reference external static pressure	Pa	200	200	200	200	300	300	300	400
Heat recovery efficiency	%	see curve							
Fan type		EC (backward curve impeller)							
Weight ¹	kg	290-350	350-420	405-480	460-560	520-630	630-750	1170-1310	1260-1400
Max power input	kW	1.5	2.5	4.4	4.4	6.5	6.5	6.6	8.9
Voltage	V	230	400						
Frequency	Hz	50							
Fan speed	min ⁻¹	2920	3000	2980	2980	2700	2700	2700	2570
Heating output T - max. ²	kW	18	27	36	46	67	75	85	90
Cooling output CHW - max. ²	kW	9	12	22	30	39	46	67	72
Cooling output CHF - max. ²	kW	10	13	25	37	41	50	55	60
Part No.		90000807	90000808	90000809	90000810	90000811	90000812	90000813	90000814

1. Depending on equipment

2. Depending on flow rate, external air temperature, medium type

T - Water heating coil

CHW - Water cooling coil

CHF - DX (direct evaporator) coil

+ excludes motors. Motor warranty one year from date of purchase.

PERFORMANCE

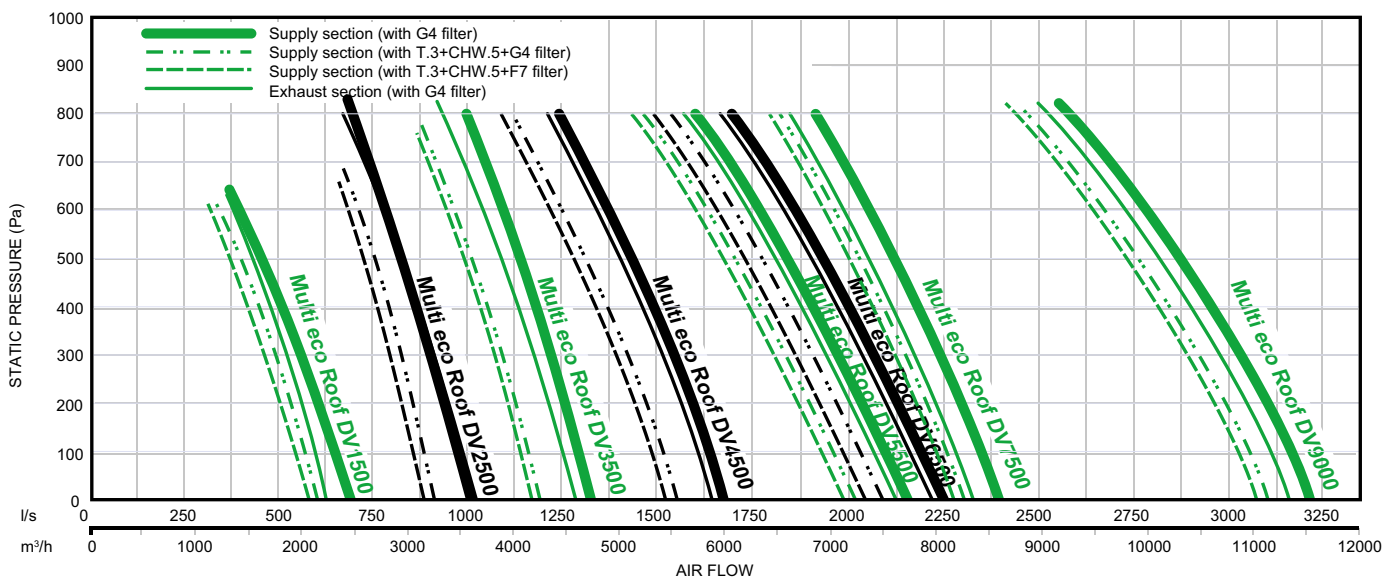

HEATING AND COOLING CAPACITY

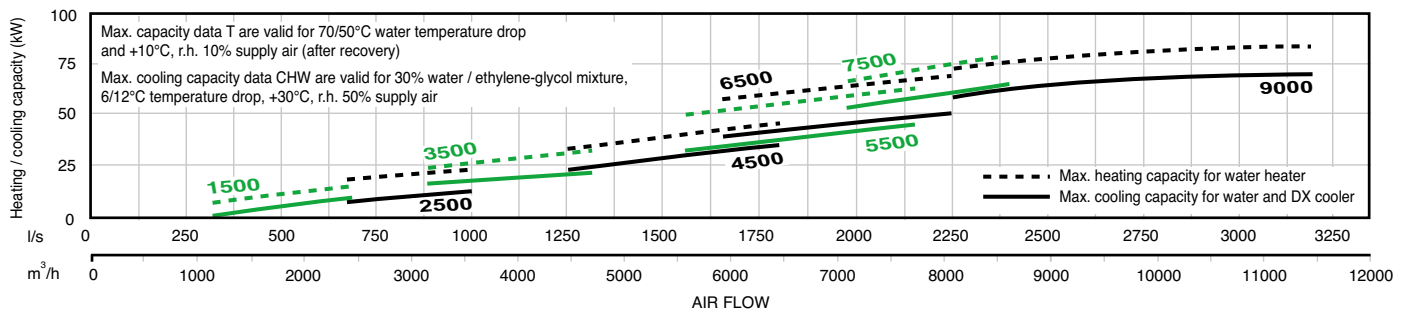

HEAT RECOVERY EFFICIENCY

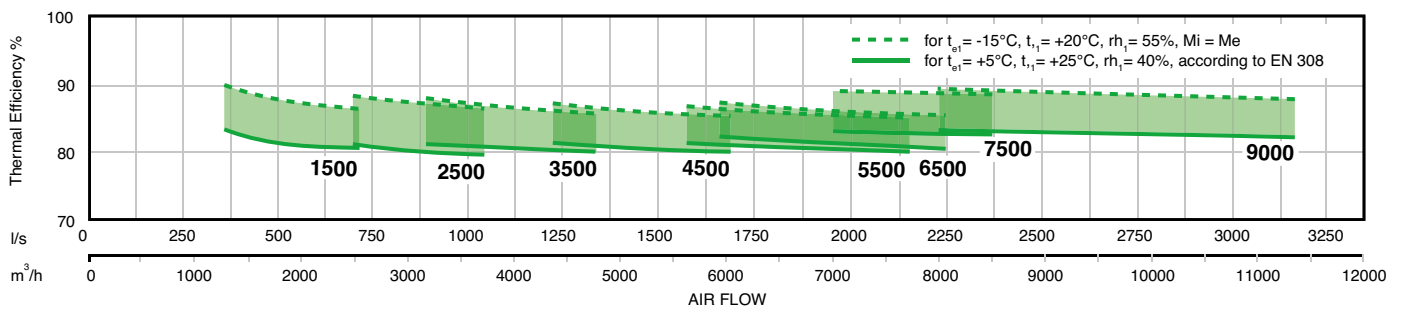

CONNECTION PORTS

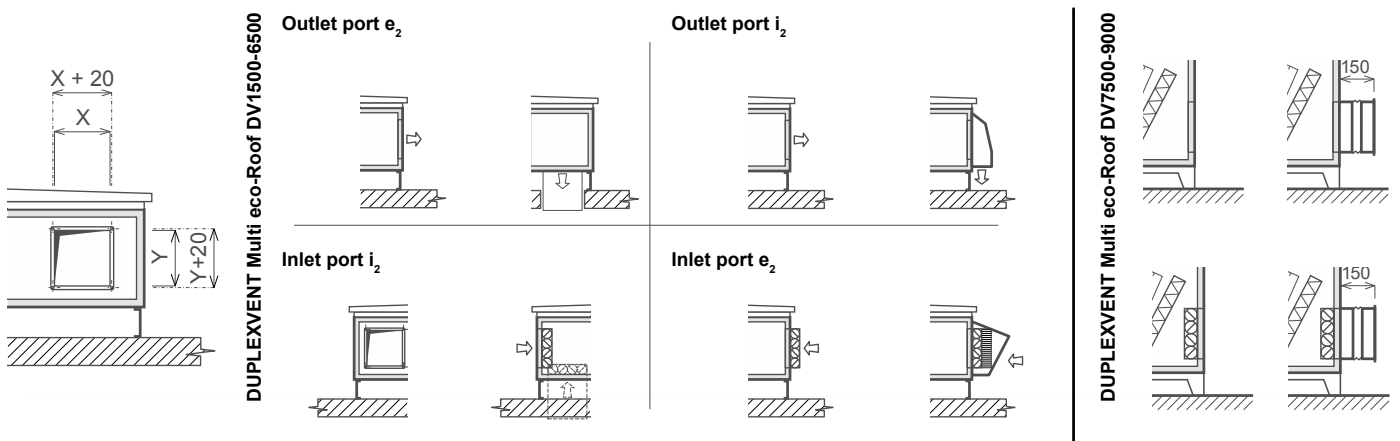

Duplexvent Multi eco Roof

Heat Recovery Ventilation

INSTALLATION CONFIGURATION

DUPLEXVENT MULTI ECO-ROOF INSTALLATION POSITIONS AND PORT CONFIGURATIONS

The Duplexvent Multi eco-Roof range is available in multiple configurations depending on the spigots location.

For a detailed unit design we recommend a Duplexvent selection software to be used; available at www.airflow.com

All Duplexvent Multi eco-Roof units are available with a wide range of accessories. For example, the ports can be fitted with flexible flanges and shut-off dampers if required.

Multi eco-Roof DV1500 - DV6500

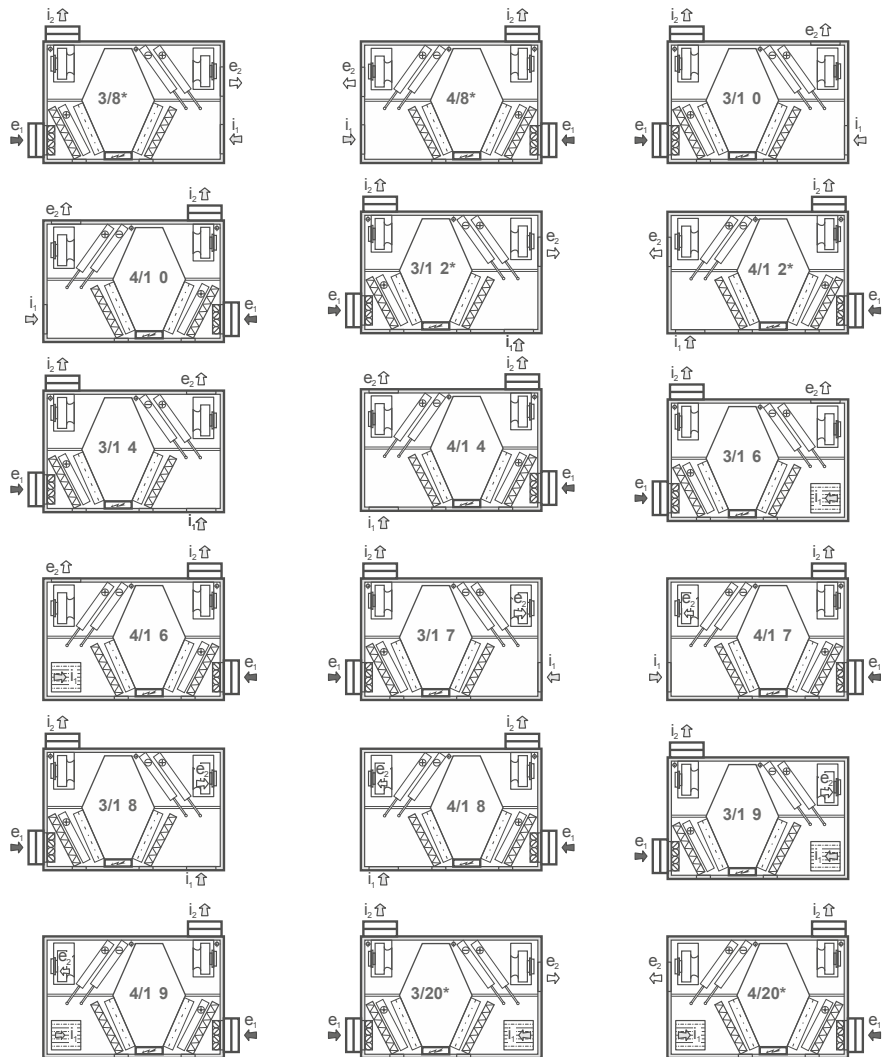
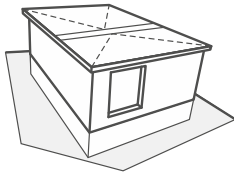

* Multi eco-Roof DV3500 - DV6500 with max. one coil

Multi eco-Roof DV7500 - DV9000

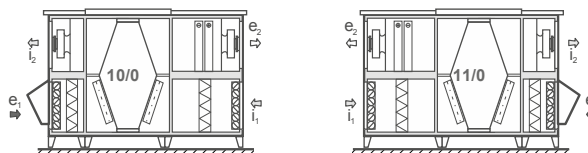
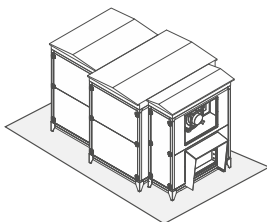

MANIPULATION SPACE

DUPLEXVENT MULTI ECO-ROOF INSTALLATION POSITIONS - CONNECTIONS THROUGH THE ROOF

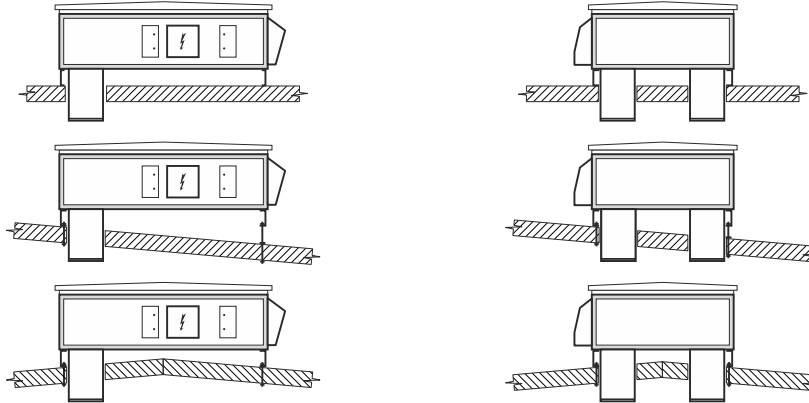

DUPLEXVENT MULTI ECO-ROOF MANIPULATION SPACE

Duplexvent Multi eco-Roof units must be installed with the unit's handling space (outlined below) in mind.

There must be a 150 mm gap underneath the unit to install the condensate drain system, as the system must run through a U-bend at least 150 mm high into the sewer. The handling space in front of the unit must be maintained so the unit can be serviced.

In addition the handling spaces outlined below, there must be a minimum 600 mm space from the side of electric switchboard of the control system.

Units fitted with additional heaters or coolers must have free space from the side of the manifold.

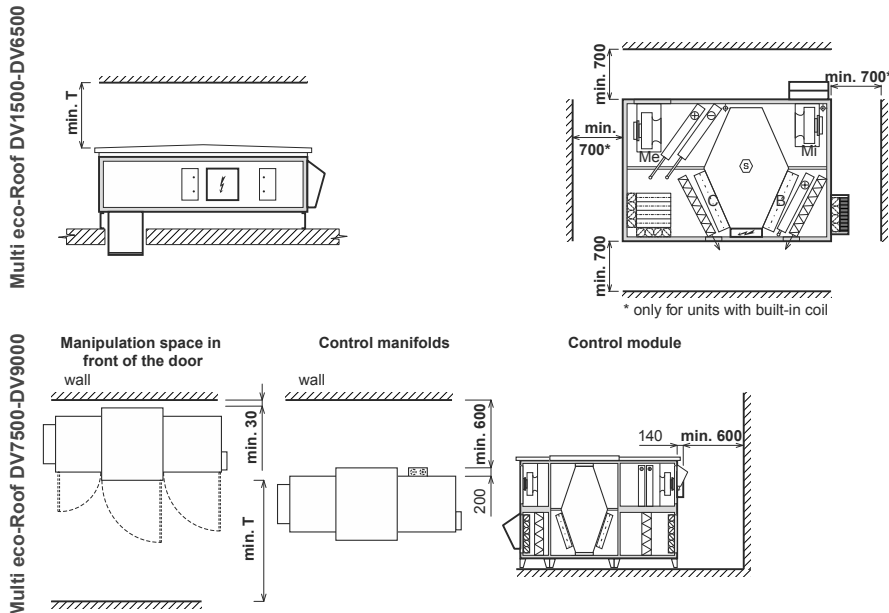

Duplexvent Multi eco-Roof	Standard door T [mm]
DV1500	600
DV2500	700
DV3500	800
DV4500	1000
DV5500	1200
DV6500	1400
DV7500	1600
DV9000	1600

Duplexvent Multi eco-Roof DV1500

Commercial MVHR with cross-counter-flow heat exchanger - Outdoor



PERFORMANCE

Ventilation		Supply Air	Extract Air
Air volume @ 200 Pa	m ³ /h / l/s	1500/417	1500/417
Nominal voltage	V	230	230
Nominal power (at operation point)	kW	0.38	0.37
Fan Speed	min ⁻¹	2426	2336
Max power input	kW	0.78	0.78
Max current	A	3.9	3.9
Fan Type		EC	EC

Note: The figures above have been measured at 1500 m³/h and 200 Pa. Please use the Duplexvent Selection Software to calculate measurements at other performance levels.

Heat Recovery		Supply Air	Extract Air
Air volume @ 200 Pa	m ³ /h / l/s	5500 / 1528	5500 / 1528
Temperature at inlet	°C	-5	20
Temperature at outlet	°C	17.4	2.7
Humidity at inlet	% RH	90	40
Humidity at outlet	% RH	18	96
Heat recovery efficiency winter / summer	%	89 / 84	
Performance in winter / summer	kW	11.6 / 2.6	
Condensation	l/h	2.7	
Type of heat exchanger		Cross-counter-flow, Plastic	
Part No.		90000807	

Note: The figures above have been measured at 1500 m³/h and 200 Pa. Please use the Duplexvent Selection Software to calculate measurements at other performance levels.

Sound Power Level L _w	Total	63 Hz	125 Hz	250 Hz	500 Hz	1 kHz	2 kHz	4 kHz	8 kHz
	dB (A)								
Outdoor air e1	56	31	40	52	49	50	43	25	<25
Supply air e2	88	63	76	85	82	80	79	67	62
Extract air i1	59	43	47	57	49	50	42	25	<25
Exhaust air i2	87	51	68	84	81	80	78	69	61
Breakout noise	62	39	54	59	55	55	45	32	<25
Sound Pressure Level L _p measured at 3m at inlet e1	35	<25	<25	31	29	30	<25	<25	<25
Sound Pressure Level L _p measured at 3m at outlet i1	67	30	47	63	61	59	58	49	41
Sound Pressure Level L _p measured at 3m	42	<25	34	39	35	34	<25	<25	<25

Note: The figures above have been measured at 1500 m³/h and 200 Pa. Please use the Duplexvent Selection Software to calculate measurements at other performance levels.

KEY FEATURES

- Air volume up to 1500 m³/h at 200 Pa according to ErP 2018
- Digital Touchscreen or simple manual controller
- Low noise, refer to NR35 and BB93 standards
- Excellent thermal insulation (class T2, TB1)
- Filters: ePM2,5 65 % (F7), ePM10 70 % (M5) or Coarse 60 % (G4)
- Optional circulation damper
- Optional constant flow and constant pressure mode
- BREEAM and ErP 2018 compliant
- Meets Building Regulations Part L2A and L2B

AIR FLOW CURVE

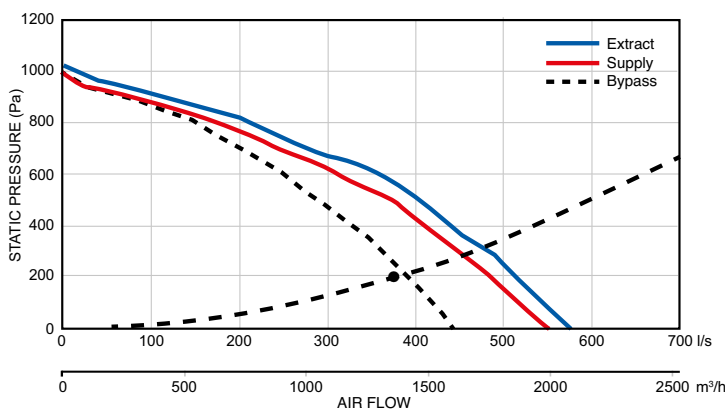

POWER CONSUMPTION

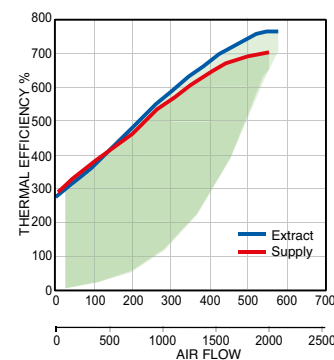

Note: Green area denotes power consumption range. Power consumption depends on system installation.

HEAT RECOVERY EFFICIENCY

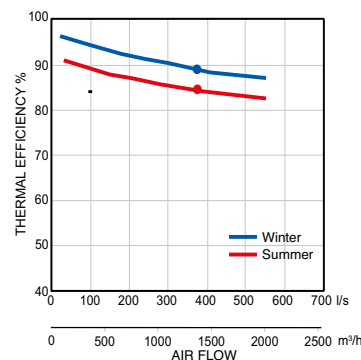

Winter Operation:

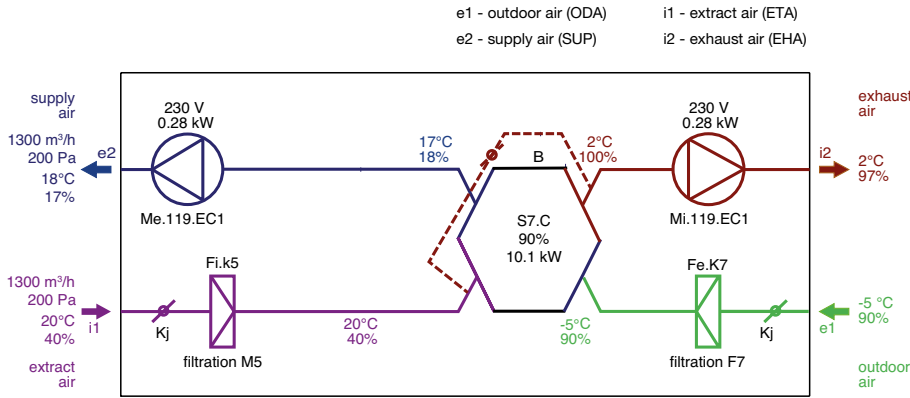

Note: AHU functions diagram. Inlet and outlet location may differ from actual position and port configuration.

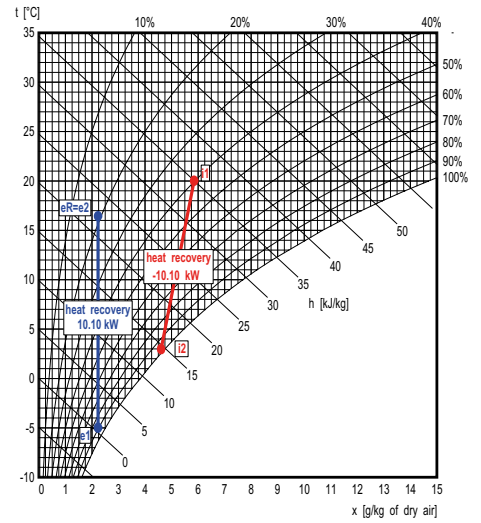

Supply

	Description	t [°C]	RH [%]
e1	Outdoor Air	-5.0	90
e2	Supply Air	17.8	18

Exhaust

	Description	t [°C]	RH [%]
i1	Extract Air	20.0	40
i2	Exhaust Air	2.3	96

Summer Operation:

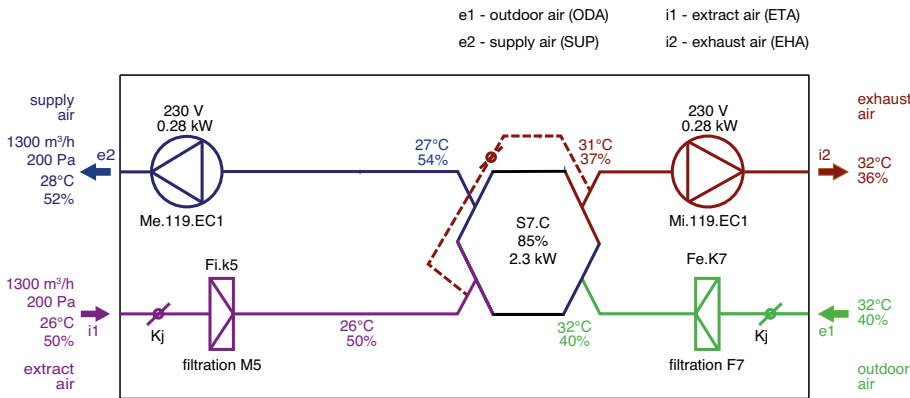

Note: AHU functions diagram. Inlet and outlet location may differ from actual position and port configuration.

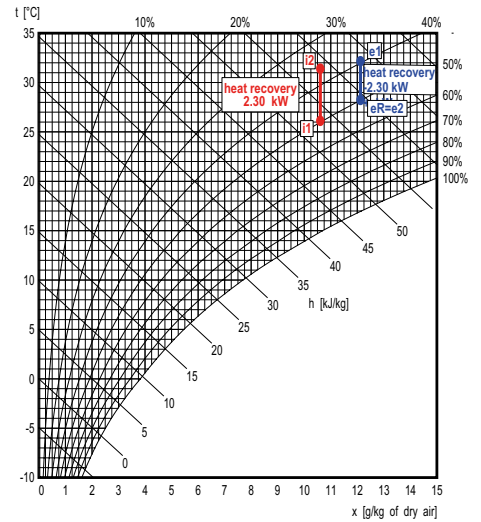

Supply

	Description	t [°C]	RH [%]
e1	Outdoor Air	32.0	40
e2	Supply Air	27.6	52

Exhaust

	Description	t [°C]	RH [%]
i1	Extract Air	26.0	50
i2	Exhaust Air	31.6	36

FILTERS

Filtration	Supply	Extract	Accessories (part of delivery)
Type	Pleated Cartridge		Pfe dirty filter pressure switch for supply air Pfi dirty filter pressure switch for extract air
Filtration class	ePM2,5 65 % (F7)	ePM10 70 % (M5)	
Number of filters	pcs 1	1	
Filter cartridge size	mm 600x380x96	600x380x96	

Duplexvent Multi eco-Roof DV1500

Commercial MVHR with cross-counter-flow heat exchanger - Outdoor

OPTIONAL ACCESSORIES

ELECTRIC PRE-HEATER

Electric pre-heater		Supply
Air volume	m ³ /h / l/s	1500 / 417
Maximum heating capacity	kW	3.0
Voltage	V	400
Connection ports	mm	Ø315

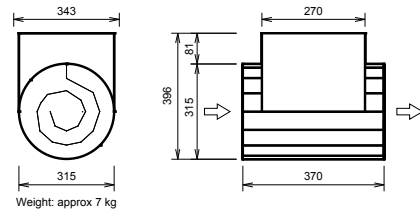

WATER HEATING COIL

Water heating coil		Supply
Heating medium		21% Ethylene glycol
Air volume	m ³ /h / l/s	1500 / 417
Temperature at inlet (after heat recovery)	°C	17
Temperature at outlet (downstream of the heater)	°C	19
Heating capacity	kW	1.1
Heating medium temperature drop	°C	70/50
Medium flow (from source)	l/h	46
Connection dimension (hydraulic kit)		5/4" female

Note: The figures above have been measured at 1500 m³/h and 200 Pa. Please use the Duplexvent Selection Software to calculate measurements at other performance levels.

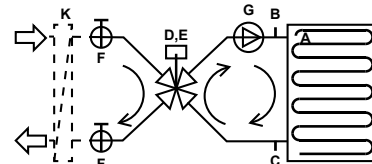

- A Freeze protection thermostat 016-H6929-109-6m
 - B Air vent automatic
 - C Sludge valve plug
 - Hydraulic kit: R-CHW3.TR 24-SR**
 - D 3-way ball valve R3020-B1
 - E Actuator
 - F Globe valve 1"
 - G Pump
 - L Water bypass 3)
 - K Coil water/ethylene glycol
- 1 - Delivered separately
2 - Fitted and connected
3 - Not part of delivery

HEATING CAPACITY

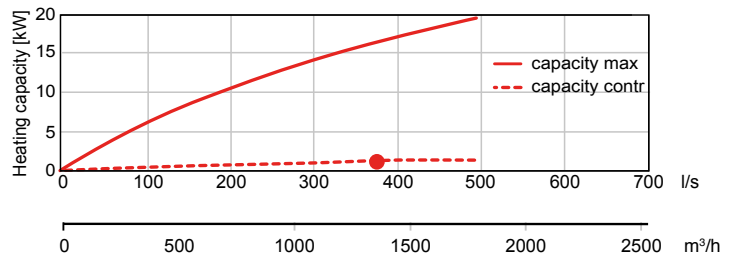

WATER COOLING COIL

Water cooling coil		Supply
Cooling medium		1500 / 417
Air volume	m ³ /h / l/s	27
Temperature at inlet (after heat recovery)	°C	16
Temperature at outlet (downstream of the cooling coil)	°C	54
Inlet relative humidity (after heat recovery)	% RH	84
Outlet relative humidity (downstream of the cooling coil)	% RH	8.4
Cooling capacity	kW	4
Condensate production	l/h	6 / 12
Water temperature drop	°C	1620
Medium flow (at max. capacity)	l/h	3260
Medium-side pressure drop		
in heat exchanger	kPa	34.65
in valve	kPa	2.58
Connection dimension		5/4" female

Note: The figures above have been measured at 5500 m³/h and 300 Pa. Please use the Duplexvent Selection Software to calculate measurements at other performance levels.

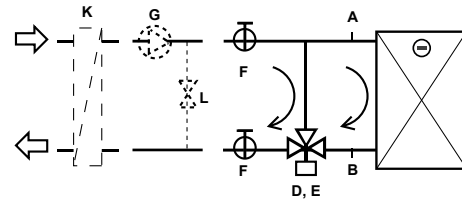

- A Air vent automatic
 - B Sludge valve plug
 - Hydraulic kit: R-CHW3.E.TR 24-SR**
 - D 3-way ball valve R3020-B1
 - E Actuator
 - F Globe valve 1"
 - G Pump
 - L Water bypass
 - K Coil water/ethylene glycol
- 1 - Delivered separately
2 - Fitted and connected
3 - Not part of delivery

COOLING CAPACITY

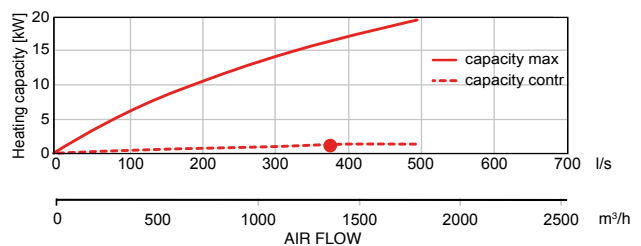

DX COIL

DX coil		Supply
Air volume	m ³ /h / l/s	1500 / 417
Temperature at inlet (after heat recovery)	°C	27
Temperature at outlet (downstream of the DX coil)	°C	16
Inlet relative humidity (after heat recovery)	% RH	54
Outlet relative humidity (downstream of the DX coil)	% RH	79
Cooling capacity	kW	7.12
Condensate production	l/h	5
Refrigerant type		R410A
Evaporating temperature	°C	10

Note: The figures above have been measured at 1500 m³/h and 200 Pa. Please use the Duplexvent Selection Software to calculate measurements at other performance levels.

COOLING CAPACITY

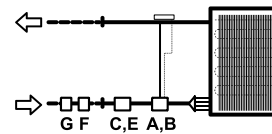
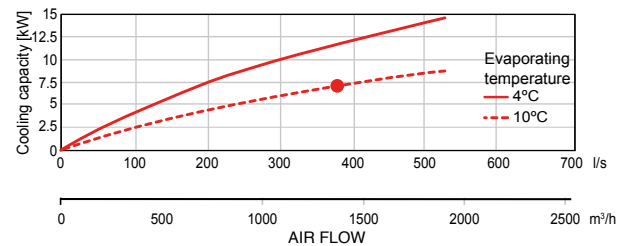

- A Expansion valve (3)
- B Nozzle (3)
- C Magnetic valve (3)
- E Coil ASC 230V/50-60 Hz (3)
- F Sight glass (3)
- G Drier (3)

3 Not part of delivery, recommended type mentioned

DIMENSIONS

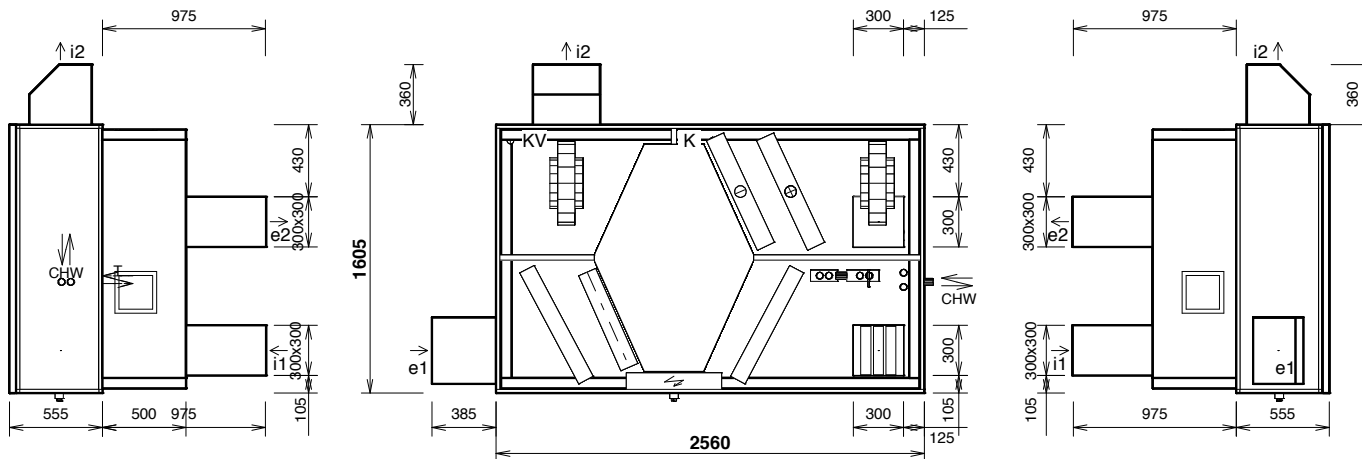
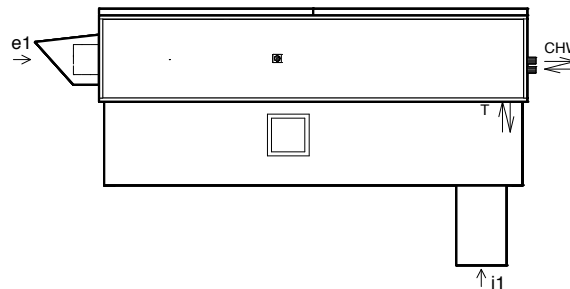

Connections	Type	Dimensions	Optional components
e1	e1- outdoor air (ODA)		Shutoff damper, Droplet eliminator
e2	e2- supply air (SUP)	300x300mm	Duct extension
i1	i1- extract air (ETA)	300x300mm	Shutoff damper, Duct extension
i2	i2- exhaust air (EHA)		
K	condensate drain	Ø 32 mm/40 mm	Condensate pump

Notice:

- Unit supplied as one piece
- Door is 3 parts
- Diagram is intended only for basic information, binding dimensions receive at device delivery, or on request from the manufacturer.
- bolt holes for duct connection (for one port): 4 x M6

Duplexvent Multi eco-Roof DV2500

Commercial MVHR with cross-counter-flow heat exchanger - Outdoor



PERFORMANCE

Ventilation		Supply Air	Extract Air
Air volume @ 200 Pa	m ³ /h / l/s	2000 / 556	2000 / 556
Nominal voltage	V	400	400
Nominal power (at operation point)	kW	0.47	0.44
Fan Speed	min ⁻¹	2115	2079
Max power input	kW	2.5	2.5
Max current	A	4	4
Fan Type		EC	EC

Note: The figures above have been measured at 2000 m³/h and 200 Pa. Please use the Duplexvent Selection Software to calculate measurements at other performance levels.

Heat Recovery		Supply Air	Extract Air
Air volume @ 200 Pa	m ³ /h / l/s	2000 / 556	2000 / 556
Temperature at inlet	°C	-5	20
Temperature at outlet	°C	17.7	2.3
Humidity at inlet	% RH	90	40
Humidity at outlet	% RH	18	97
Heat recovery efficiency winter / summer	%	89 / 84	
Performance in winter / summer	kW	15.4 / 3.5	
Condensation	l/h	3.7	
Type of heat exchanger		Cross-counter-flow, Plastic	
Part No.		90000808	

Note: The figures above have been measured at 2000 m³/h and 200 Pa. Please use the Duplexvent Selection Software to calculate measurements at other performance levels.

Sound Power Level L _w	Total	dB (A)							
		63 Hz	125 Hz	250 Hz	500 Hz	1 kHz	2 kHz	4 kHz	8 kHz
Outdoor air e1	55	<25	33	54	41	44	36	<25	<25
Supply air e2	80	53	61	78	71	71	68	64	57
Extract air i1	54	28	38	53	38	42	34	<25	<25
Exhaust air i2	77	36	56	74	69	69	66	62	54
Breakout noise	59	43	49	55	55	49	44	30	<25
Sound Pressure Level L _p measured at 3m at inlet e1	34	<25	<25	34	<25	<25	<25	<25	<25
Sound Pressure Level L _p measured at 3m at outlet i1	56	<25	36	53	48	48	45	42	34
Sound Pressure Level L _p measured at 3m	38	<25	29	34	34	28	<25	<25	<25

Note: The figures above have been measured at 2000 m³/h and 200 Pa. Please use the Duplexvent Selection Software to calculate measurements at other performance levels.

KEY FEATURES

- Air volume up to 2000 m³/h at 200 Pa according to ErP 2018
- Digital Touchscreen or simple manual controller
- Low noise, refer to NR35 and BB93 standards
- Excellent thermal insulation (class T2, TB1)
- Filters: ePM2,5 65 % (F7), ePM10 70 % (M5) or Coarse 60 % (G4)
- Optional circulation damper
- Optional constant flow and constant pressure mode
- BREEAM and ErP 2018 compliant
- Meets Building Regulations Part L2A and L2B

AIR FLOW CURVE

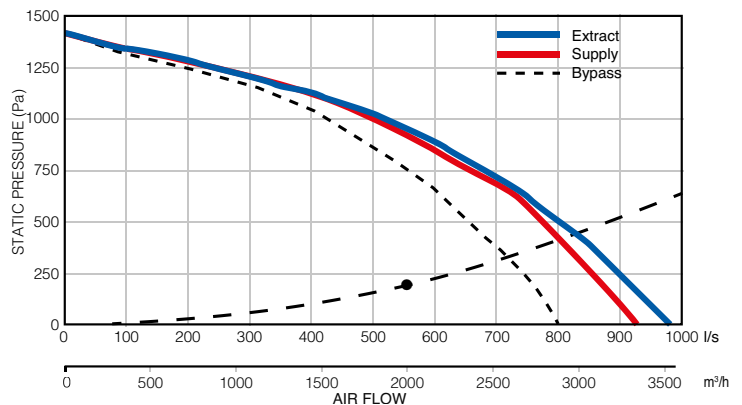

POWER CONSUMPTION

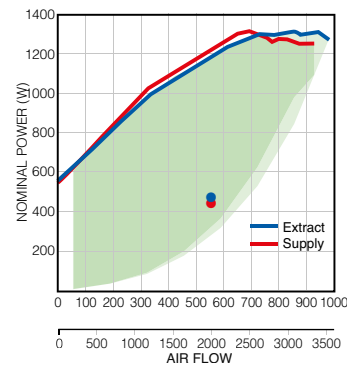

Note: Green area denotes power consumption range. Power consumption depends on system installation.

HEAT RECOVERY EFFICIENCY

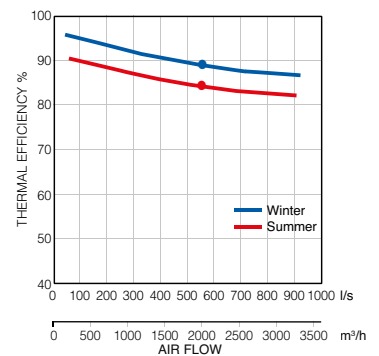

Winter Operation:

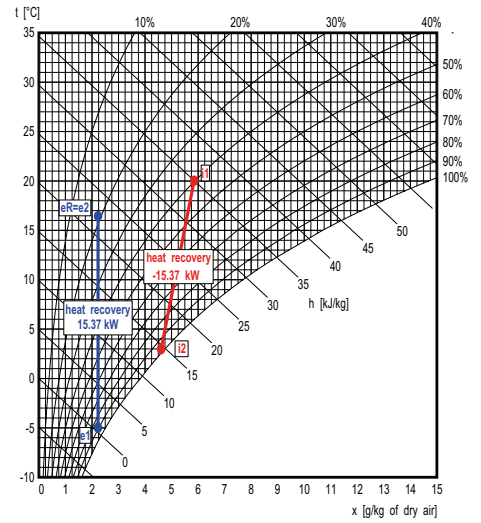
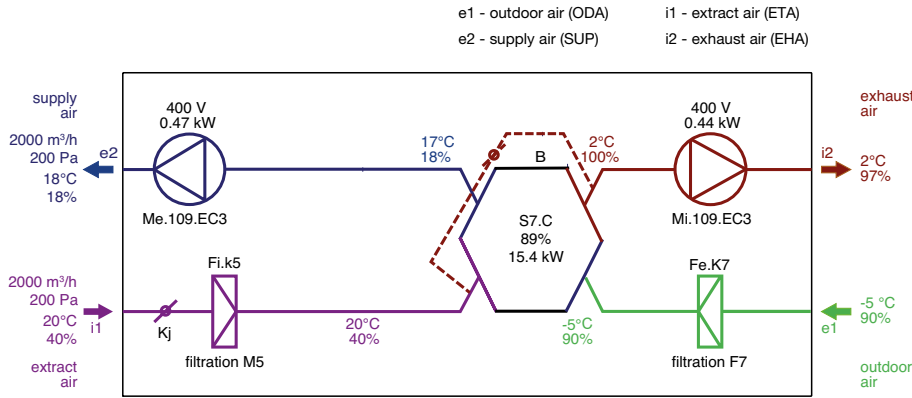

Supply

Description	t [°C]	RH [%]
e1 Outdoor Air	-5.0	90
e2 Supply Air	17.7	18

Exhaust

Description	t [°C]	RH [%]
i1 Extract Air	20.0	40
i2 Exhaust Air	2.3	97

Summer Operation:

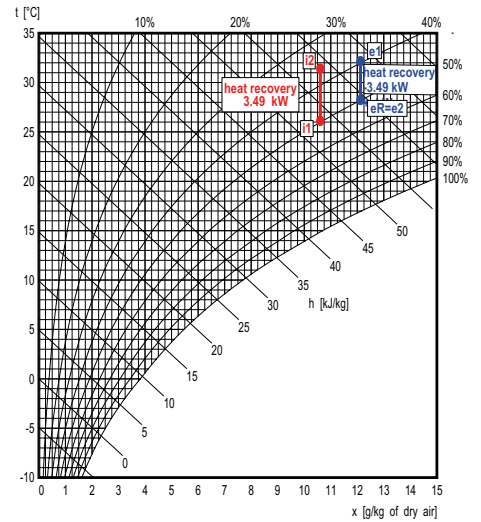
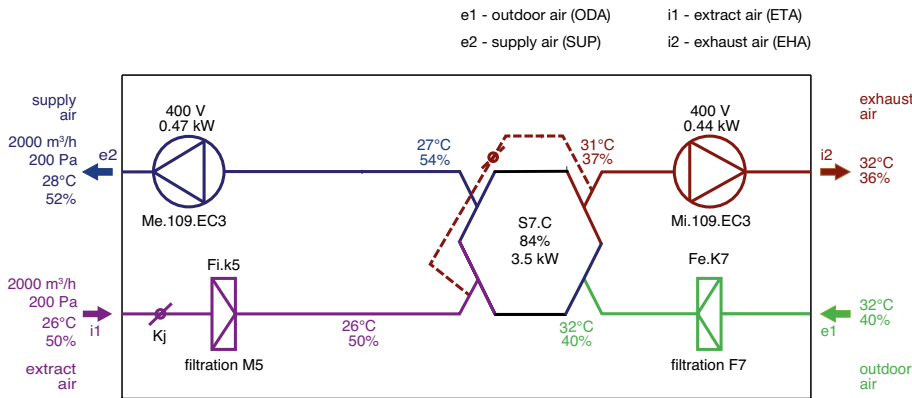

Supply

Description	t [°C]	RH [%]
e1 Outdoor Air	32.0	40
e2 Supply Air	27.6	52

Exhaust

Description	t [°C]	RH [%]
i1 Extract Air	26.0	50
i2 Exhaust Air	31.5	36

FILTERS

Filtration	Supply	Extract	Accessories (part of delivery)
Type	Pleated Cartridge		Pfe dirty filter pressure switch for supply air Pfi dirty filter pressure switch for extract air
Filtration class	ePM2,5 65 % (F7)	ePM10 70 % (M5)	
Number of filters	pcs 1	1	
Filter cartridge size	mm 750x495x96	750x495x96	

Duplexvent Multi eco-Roof DV2500

Commercial MVHR with cross-counter-flow heat exchanger - Outdoor

OPTIONAL ACCESSORIES

ELECTRIC PRE-HEATER

Electric pre-heater		Supply
Air volume	m ³ /h / l/s	2000 / 556
Maximum heating capacity	kW	6.0
Voltage	V	400
Connection ports	mm	250x500

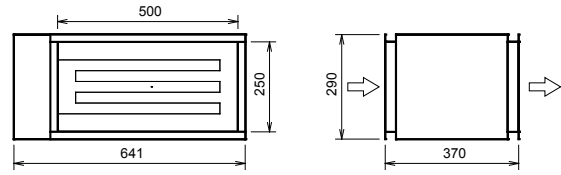

Weight approx. 19 kg

WATER HEATING COIL

Water heating coil		Supply
Heating medium		Water
Air volume	m ³ /h / l/s	2000 / 556
Temperature at inlet (after heat recovery)	°C	17
Temperature at outlet (downstream of the heater)	°C	19
Heating capacity	kW	1.5
Heating medium temperature drop	°C	70/50
Medium flow (from source)	l/h	64
Connection dimension (hydraulic kit)		5/4" female

Note: The figures above have been measured at 2000 m³/h and 200 Pa. Please use the Duplexvent Selection Software to calculate measurements at other performance levels.

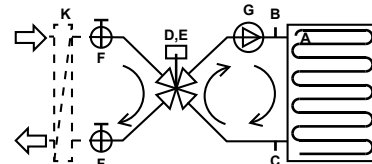

- A Freeze protection thermostat 016-H6927-107-3m
 - B Air vent automatic
 - C Sludge valve plug
 - Hydraulic kit: RE-TPO4. LM24A-SR
 - D Mixing valve
 - E Actuator
 - F Globe valve 1"
 - G Pump
 - L Water bypass
 - Others:
 - K Coil water/ethylene glycol
- 1 - Delivered separately
 2 - Fitted and connected
 3 - Not part of delivery, recommended

HEATING CAPACITY

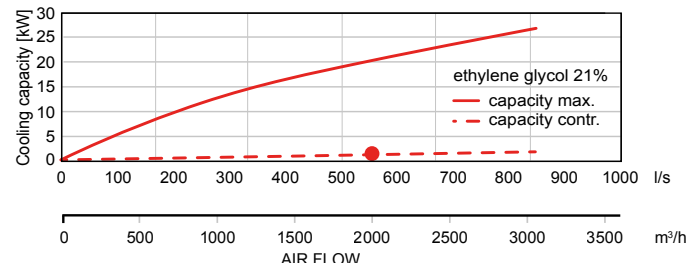

WATER COOLING COIL

Water cooling coil		Supply
Cooling medium		21% Ethylene glycol
Air volume	m ³ /h / l/s	2000 / 556
Temperature at inlet (after heat recovery)	°C	27
Temperature at outlet (downstream of the cooling coil)	°C	16
Inlet relative humidity (after heat recovery)	% RH	54
Outlet relative humidity (downstream of the cooling coil)	% RH	84
Cooling capacity	kW	11.1
Condensate production	l/h	6
Water temperature drop	°C	6 / 12
Medium flow (at max. capacity)	l/h	1980
Medium-side pressure drop		
in heat exchanger	kPa	28.93
in valve	kPa	3.85
Connection dimension		5/4" female

Note: The figures above have been measured at 2000 m³/h and 300 Pa. Please use the Duplexvent Selection Software to calculate measurements at other performance levels.

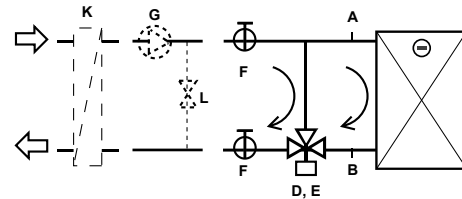

- A Air vent automatic
 - B Sludge valve plug
 - Hydraulic kit: R-CHW3.E.TR 24-SR
 - D 3-way ball valve
 - E Actuator
 - F Globe valve
 - Others:
 - G Pump
 - L Water bypass
 - K Coil water/ethylene glycol
- 1 - Delivered separately
 t

COOLING CAPACITY

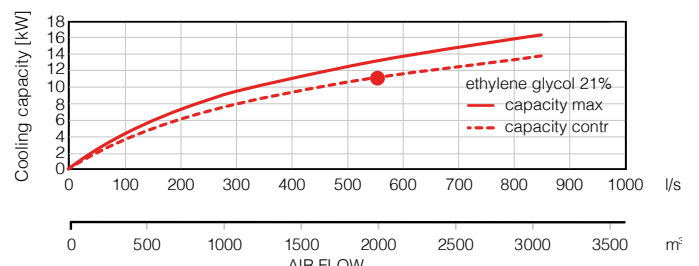

DX COIL

DX coil		Supply
Air volume	m ³ /h / l/s	2000 / 556
Temperature at inlet (after heat recovery)	°C	27
Temperature at outlet (downstream of the DX coil)	°C	17
Inlet relative humidity (after heat recovery)	% RH	54
Outlet relative humidity (downstream of the DX coil)	% RH	77
Cooling capacity	kW	11.28
Condensate production	l/h	7
Refrigerant type		R410A
Evaporating temperature	°C	4

Note: The figures above have been measured at 2000 m³/h and 200 Pa. Please use the Duplexvent Selection Software to calculate measurements at other performance levels.

COOLING CAPACITY

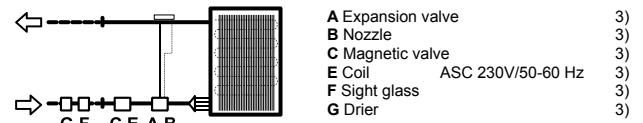
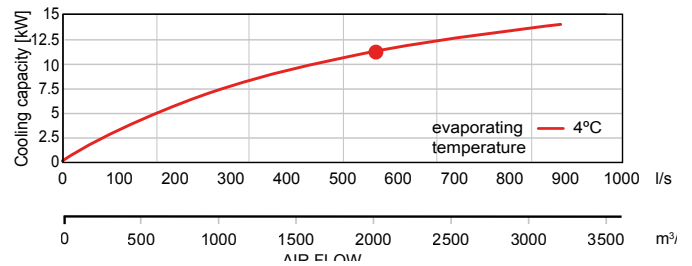

3 Not part of delivery, recommended type mentioned

DIMENSIONS

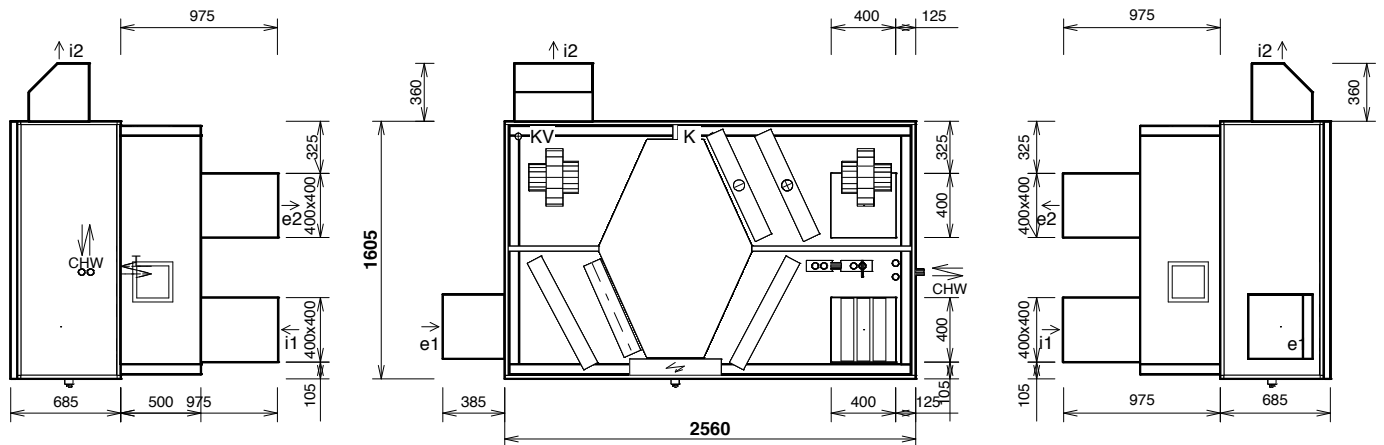
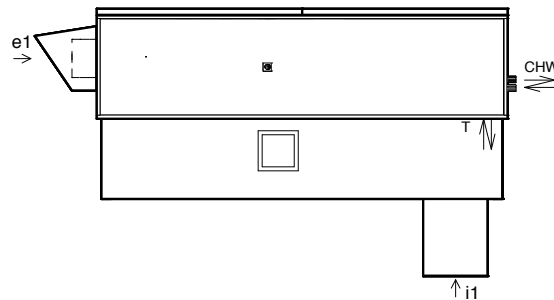

Connections	Type	Dimensions	Optional components
e1	e1- outdoor air (ODA)		Shutoff damper, Flexible connection
e2	e2- supply air (SUP)	400x400mm	Flexible connection
i1	i1- extract air (ETA)	400x400mm	Shutoff damper, Flexible connection
i2	i2- exhaust air (EHA)		Flexible connection
K	condensate drain	Ø 32 mm/40 mm	Condensate pump

Notice:

- Terminal Strip placed inside a unit
- Diagram is intended only for basic information, binding dimensions receive at device delivery, or on request from the manufacturer
- Bolt holes for duct connection (for one port): 4x M6
- incl: base frame heights 500mm
- Duct extension e2
- Duct extensions i1

Duplexvent Multi eco-Roof DV3500

Commercial MVHR with cross-counter-flow heat exchanger - Outdoor



PERFORMANCE

Ventilation		Supply Air	Extract Air
Air volume @ 200 Pa	m ³ /h / l/s	2700 / 750	2700 / 750
Nominal voltage	V	400	400
Nominal power (at operation point)	kW	0.77	0.66
Fan Speed	min ⁻¹	2088	2033
Max power input	kW	2.5	2.5
Max current	A	3.8	3.8
Fan Type		EC	EC

Note: The figures above have been measured at 2700 m³/h and 200 Pa. Please use the Duplexvent Selection Software to calculate measurements at other performance levels.

Heat Recovery		Supply Air	Extract Air
Air volume @ 200 Pa	m ³ /h / l/s	2700 / 750	2700 / 750
Temperature at inlet	°C	-5	20
Temperature at outlet	°C	17.6	2.5
Humidity at inlet	% RH	90	40
Humidity at outlet	% RH	18	96
Heat recovery efficiency winter / summer	%	88 / 83	
Performance in winter / summer	kW	20.5 / 4.7	
Condensation	l/h	4.9	
Type of heat exchanger		Cross-counter-flow, Plastic	
Part No.		90000809	

Note: The figures above have been measured at 2700 m³/h and 200 Pa. Please use the Duplexvent Selection Software to calculate measurements at other performance levels.

Sound Power Level L _w	Total	dB (A)							
		63 Hz	125 Hz	250 Hz	500 Hz	1 kHz	2 kHz	4 kHz	8 kHz
Outdoor air e1	55	29	37	52	49	47	40	<25	<25
Supply air e2	83	57	65	81	74	74	71	67	60
Extract air i1	55	38	43	52	49	47	40	<25	<25
Exhaust air i2	81	47	59	79	73	73	70	66	59
Breakout noise	57	37	48	55	51	47	38	31	<25
Sound Pressure Level L _p measured at 3m at inlet e1	34	<25	<25	31	29	27	<25	<25	<25
Sound Pressure Level L _p measured at 3m at outlet i2	61	26	38	59	53	53	50	45	39
Sound Pressure Level L _p measured at 3m	37	<25	27	34	31	26	<25	<25	<25

Note: The figures above have been measured at 2700 m³/h and 200 Pa. Please use the Duplexvent Selection Software to calculate measurements at other performance levels.

KEY FEATURES

- Air volume up to 2700 m³/h at 200 Pa according to ErP 2018
- Digital Touchscreen or simple manual controller
- Low noise, refer to NR35 and BB93 standards
- Excellent thermal insulation (class T2, TB1)
- Filters: ePM2,5 65 % (F7), ePM10 70 % (M5) or Coarse 60 % (G4)
- Optional circulation damper
- Optional constant flow and constant pressure mode
- BREEAM and ErP 2018 compliant
- Meets Building Regulations Part L2A and L2B

AIR FLOW CURVE

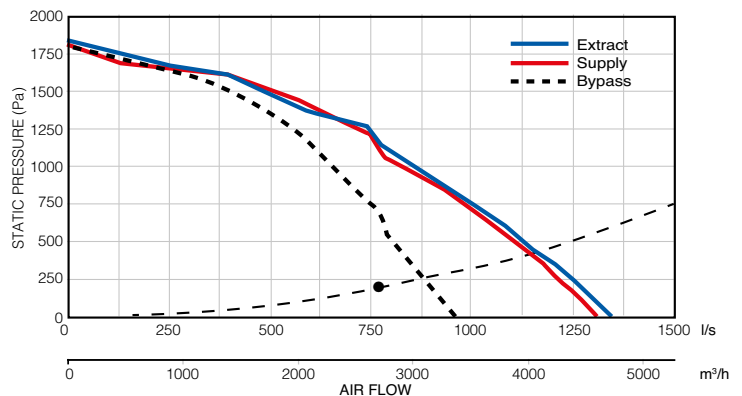

POWER CONSUMPTION

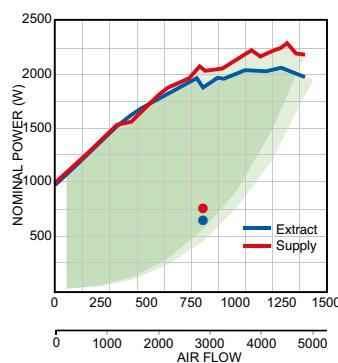

Note: Green area denotes power consumption range. Power consumption depends on system installation.

HEAT RECOVERY EFFICIENCY

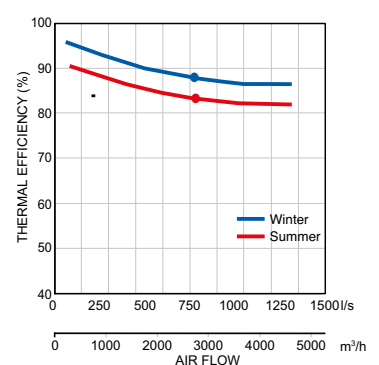

Winter Operation:

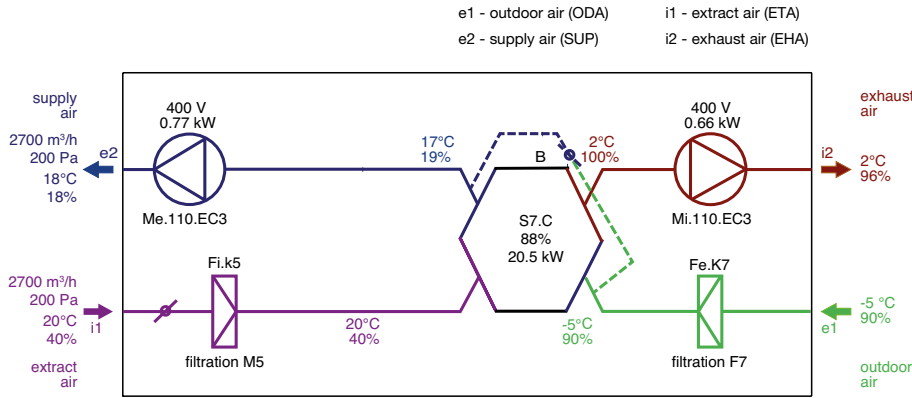

Note: AHU functions diagram. Inlet and outlet location may differ from actual position and port configuration.

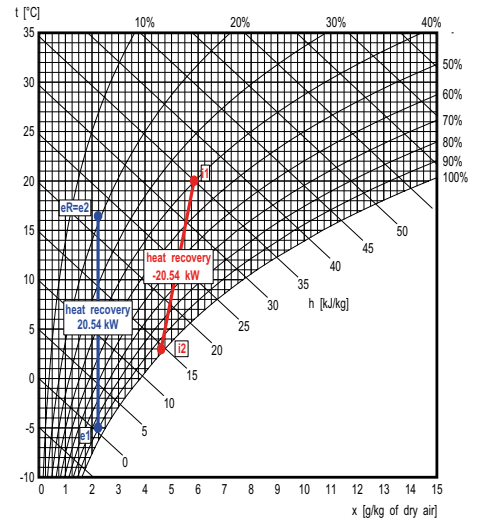

Supply

	Description	t [°C]	RH [%]
e1	Outdoor Air	-5.0	90
e2	Supply Air	17.6	18

Exhaust

	Description	t [°C]	RH [%]
i1	Extract Air	20.0	40
i2	Exhaust Air	2.5	96

Summer Operation:

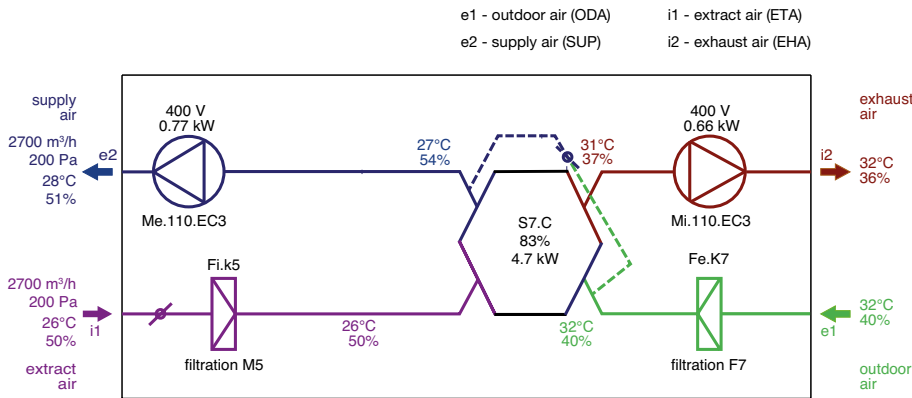

Note: AHU functions diagram. Inlet and outlet location may differ from actual position and port configuration.

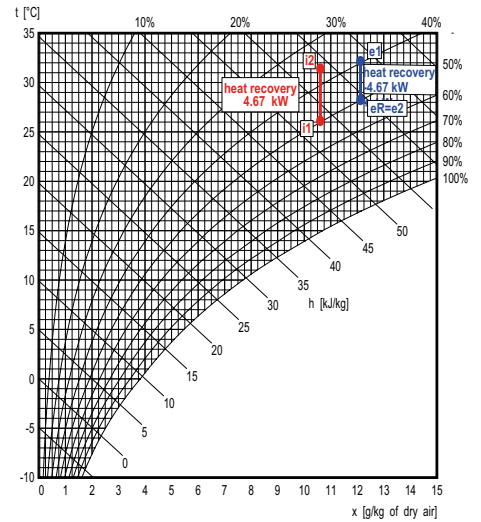

Supply

	Description	t [°C]	RH [%]
e1	Outdoor Air	32.0	40
e2	Supply Air	27.7	51

Exhaust

	Description	t [°C]	RH [%]
i1	Extract Air	26.0	50
i2	Exhaust Air	31.5	36

FILTERS

Filtration	Supply	Extract	Accessories (part of delivery)
Type	Pleated Cartridge		Pfe dirty filter pressure switch for supply air Pfi dirty filter pressure switch for extract air
Filtration class	ePM2,5 65 % (F7)	ePM10 70 % (M5)	
Number of filters	2	2	
Filter cartridge size	750x295x96	750x295x96	

Duplexvent Multi eco-Roof DV3500

Commercial MVHR with cross-counter-flow heat exchanger - Outdoor

OPTIONAL ACCESSORIES

ELECTRIC PRE-HEATER

Electric pre-heater		Supply
Air volume	m ³ /h / l/s	2700 / 750
Maximum heating capacity	kW	9.0
Voltage	V	400
Connection ports	mm	300x600

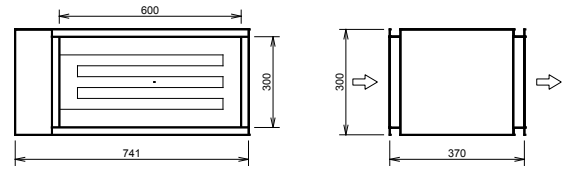

Weight: approx. 38 kg

WATER HEATING COIL

Water heating coil		Supply
Heating medium		21% Ethylene glycol
Air volume	m ³ /h / l/s	2700 / 750
Temperature at inlet (after heat recovery)	°C	17
Temperature at outlet (downstream of the heater)	°C	19
Heating capacity	kW	2.1
Heating medium temperature drop	°C	70/50
Medium flow (from source)	l/h	89
Connection dimension (hydraulic kit)		5/4" female

Note: The figures above have been measured at 2700 m³/h and 200 Pa. Please use the Duplexvent Selection Software to calculate measurements at other performance levels.

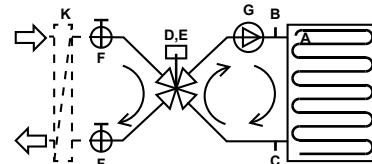

- A Freeze protection thermostat 016-H6929-109-6m
 - B Air vent automatic
 - C Sludge valve plug
 - Hydraulic kit: RE-TPO4. LM24A-SR
 - D Mixing valve
 - E Actuator
 - F Globe valve 1"
 - G Pump
- Others:
- K Coil water/ethylene glycol
- 1 - Delivered separately
2 - Fitted and connected
3 - Not part of delivery, recommended

HEATING CAPACITY

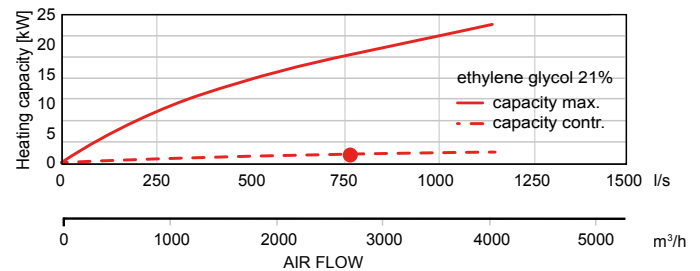

WATER COOLING COIL

Water cooling coil		Supply
Cooling medium		21% Ethylene glycol
Air volume	m ³ /h / l/s	2700 / 750
Temperature at inlet (after heat recovery)	°C	27
Temperature at outlet (downstream of the cooling coil)	°C	16
Inlet relative humidity (after heat recovery)	% RH	53
Outlet relative humidity (downstream of the cooling coil)	% RH	86
Cooling capacity	kW	14.9
Condensate production	l/h	8
Water temperature drop	°C	6 / 12
Medium flow (at max. capacity)	l/h	2590
Medium-side pressure drop		
in heat exchanger	kPa	29.82
in valve	kPa	6.57
Connection dimension		5/4" female

Note: The figures above have been measured at 2700 m³/h and 200 Pa. Please use the Duplexvent Selection Software to calculate measurements at other performance levels.

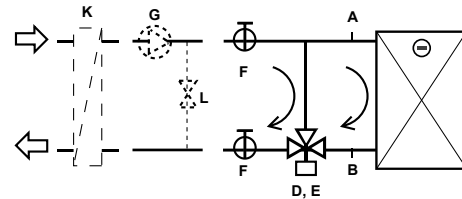

- A Air vent automatic
 - B Sludge valve plug
 - Hydraulic kit: R-CHW3.E.TR 24-SR
 - D 3-way ball valve
 - E Actuator
 - F Globe valve
 - G Pump
 - L Water bypass
 - K Coil water/ethylene glycol
- Others:
- R3020-B1 TR 24-SR 1"
- 1 - Delivered separately
2 - Fitted and connected
3 - Not part of delivery

COOLING CAPACITY

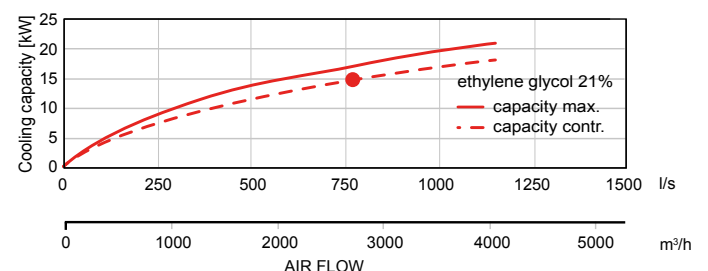

DX COIL

DX coil		Supply
Air volume	m ³ /h / l/s	2700 / 750
Temperature at inlet (after heat recovery)	°C	27
Temperature at outlet (downstream of the DX coil)	°C	17
Inlet relative humidity (after heat recovery)	% RH	53
Outlet relative humidity (downstream of the DX coil)	% RH	80
Cooling capacity	kW	15.32
Condensate production	l/h	9
Refrigerant type		R410A
Evaporating temperature	°C	4

Note: The figures above have been measured at 2700 m³/h and 200 Pa. Please use the Duplexvent Selection Software to calculate measurements at other performance levels.

COOLING CAPACITY

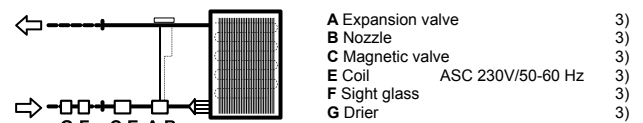
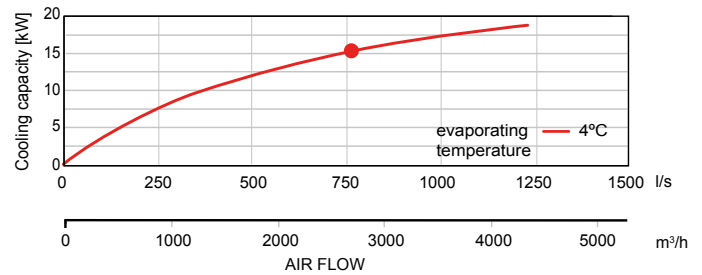

- A Expansion valve 3)
- B Nozzle 3)
- C Magnetic valve 3)
- E Coil ASC 230V/50-60 Hz 3)
- F Sight glass 3)
- G Drier 3)

3 Not part of delivery, recommended type mentioned

DIMENSIONS

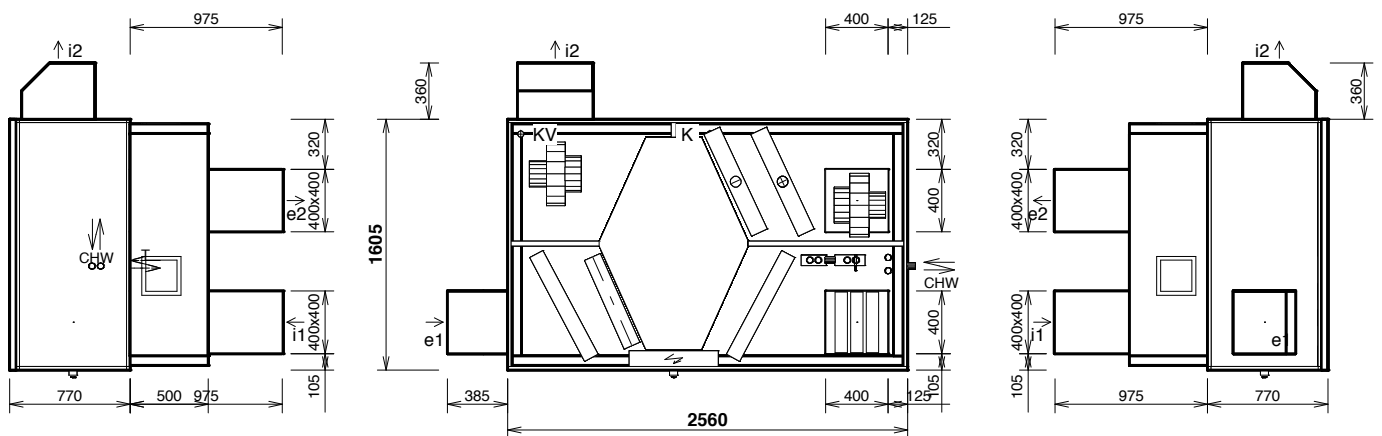
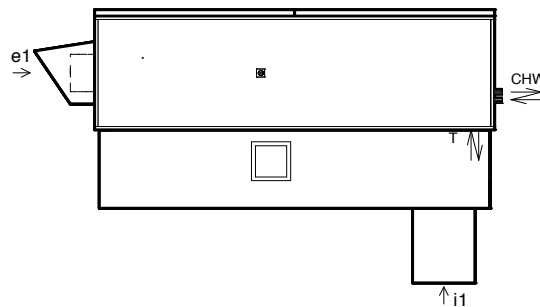

Connections	Type	Dimensions	Optional accessories
e1	e1- outdoor air (ODA)		Shutoff damper, Flexible connection
e2	e2- supply air (SUP)	400x400 mm	Flexible connection
i1	i1- extract air (ETA)	400x400 mm	Shutoff damper, Flexible connection
i2	i2- exhaust air (EHA)		Flexible connection
K	condensate drain	Ø 32 mm / 40 mm	Condensate pump

Notice:

- Terminal strip placed inside a unit
- Diagram is intended only for basic information, binding dimensions receive at device delivery, or on request from the manufacturer
- Bolt holes for duct connection (for one port): 4x M6
- incl: base frame heights 500mm
- Duct extension e2
- Duct extensions i1

Duplexvent Multi eco-Roof DV4500

Commercial MVHR with cross-counter-flow heat exchanger - Outdoor



PERFORMANCE

Ventilation		Supply Air	Extract Air
Air volume @ 200 Pa	m ³ /h / l/s	4000 / 1111	4000 / 1111
Nominal voltage	V	400	400
Nominal power (at operation point)	kW	0.9	0.7
Fan Speed	min ⁻¹	1860	1732
Max power input	kW	2.5	2.5
Max current	A	3.8	3.8
Fan Type		EC	EC

Note: The figures above have been measured at 4000 m³/h and 200 Pa. Please use the Duplexvent Selection Software to calculate measurements at other performance levels.

Heat Recovery		Supply Air	Extract Air
Air volume @ 200 Pa	m ³ /h / l/s	4000 / 1111	4000 / 1111
Temperature at inlet	°C	-5	20
Temperature at outlet	°C	17.4	2.4
Humidity at inlet	% RH	90	40
Humidity at outlet	% RH	18	97
Heat recovery efficiency winter / summer	%	87 / 83	
Performance in winter / summer	kW	30.3 / 6.9	
Condensation	l/h	7.2	
Type of heat exchanger		Cross-counter-flow, Plastic	
Part No.		90000810	

Note: The figures above have been measured at 4000 m³/h and 200 Pa. Please use the Duplexvent Selection Software to calculate measurements at other performance levels.

Sound Power Level L _w	Total	dB (A)							
		63 Hz	125 Hz	250 Hz	500 Hz	1 kHz	2 kHz	4 kHz	8 kHz
Outdoor air e1	64	36	47	60	60	55	46	44	31
Supply air e2	89	63	70	78	85	84	77	69	60
Extract air i1	64	42	49	57	62	49	39	29	<25
Exhaust air i2	88	54	65	78	85	83	75	68	61
Breakout noise	61	29	37	58	56	51	48	42	32
Sound Pressure Level L _p measured at 3m at inlet e1	43	<25	27	39	39	35	25	<25	<25
Sound Pressure Level L _p measured at 3m at outlet i2	67	34	45	57	64	62	55	48	40
Sound Pressure Level L _p measured at 3m	40	<25	<25	37	35	31	27	<25	<25

Note: The figures above have been measured at 4000 m³/h and 200 Pa. Please use the Duplexvent Selection Software to calculate measurements at other performance levels.

KEY FEATURES

- Air volume up to 4000 m³/h at 200 Pa according to ErP 2018
- Digital Touchscreen or simple manual controller
- Low noise, refer to NR35 and BB93 standards
- Excellent thermal insulation (class T2, TB1)
- Filters: ePM2,5 65 % (F7), ePM10 70 % (M5) or Coarse 60 % (G4)
- Optional circulation damper
- Optional constant flow and constant pressure mode
- BREEAM and ErP 2018 compliant
- Meets Building Regulations Part L2A and L2B

AIR FLOW CURVE

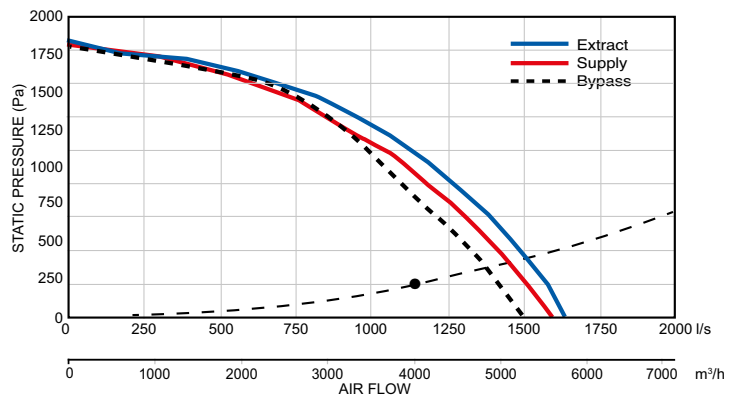

POWER CONSUMPTION

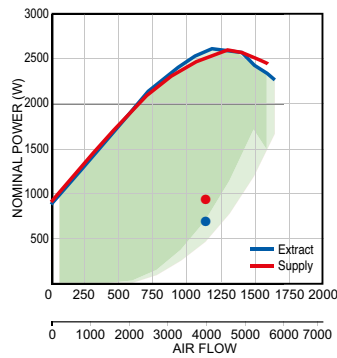

Note: Green area denotes power consumption range. Power consumption depends on system installation.

HEAT RECOVERY EFFICIENCY

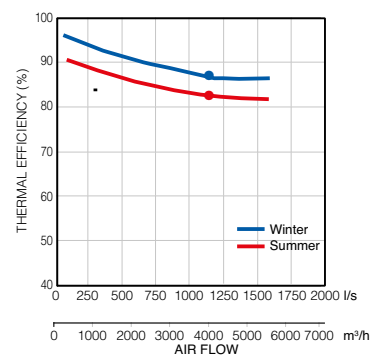

Winter Operation:

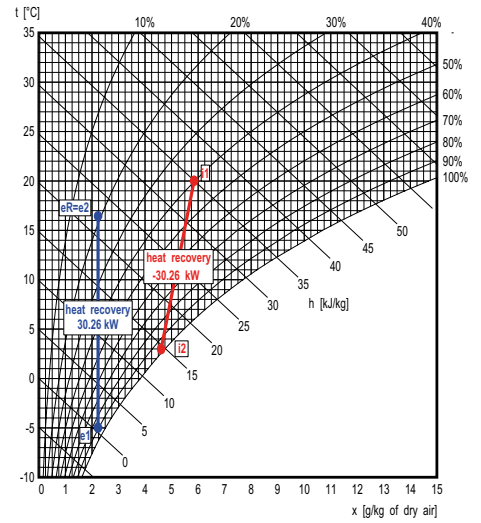
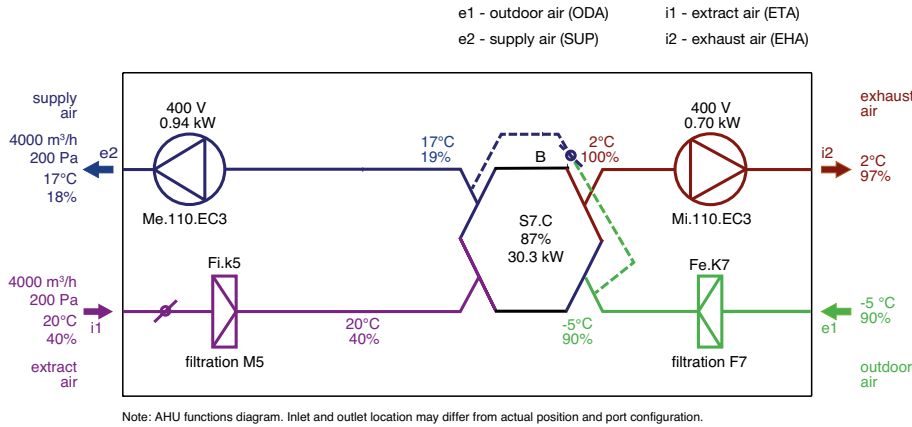

Supply

	Description	t [°C]	RH [%]
e1	Outdoor Air	-5.0	90
e2	Supply Air	17.4	18

Exhaust

	Description	t [°C]	RH [%]
i1	Extract Air	20.0	40
i2	Exhaust Air	2.4	97

Summer Operation:

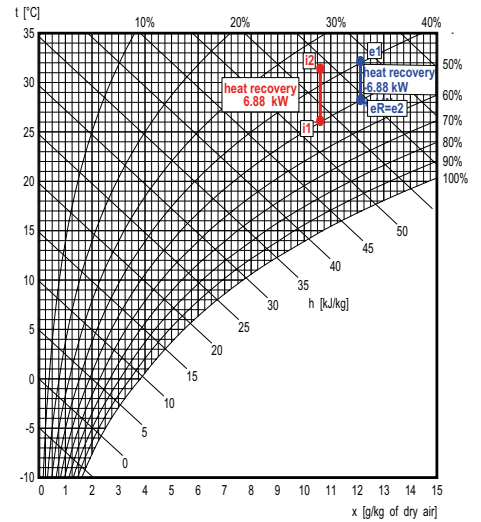
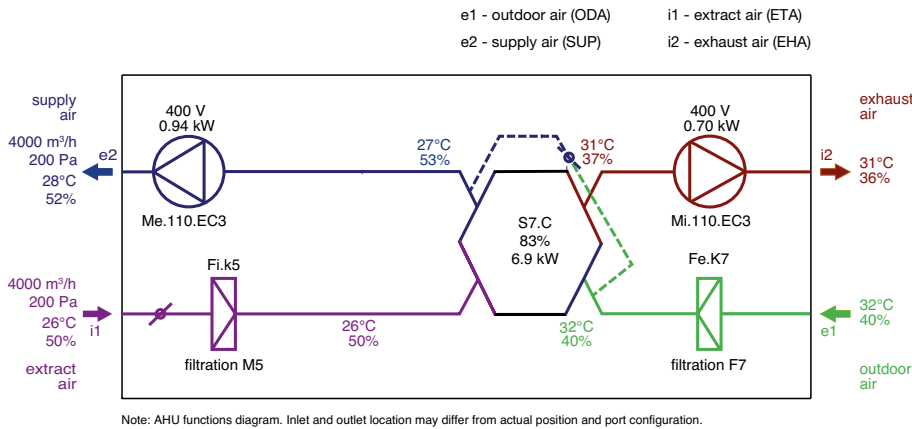

Supply

	Description	t [°C]	RH [%]
e1	Outdoor Air	32.0	40
e2	Supply Air	27.7	52

Exhaust

	Description	t [°C]	RH [%]
i1	Extract Air	26.0	50
i2	Exhaust Air	31.4	36

FILTERS

Filtration	Supply	Extract	Accessories (part of delivery)
Type	Pleated Cartridge		Pfe dirty filter pressure switch for supply air Pfi dirty filter pressure switch for extract air
Filtration class	ePM2,5 65 % (F7)	ePM10 70 % (M5)	
Number of filters	2	2	
Filter cartridge size	750x405x96	750x405x96	

Duplexvent Multi eco-Roof DV4500

Commercial MVHR with cross-counter-flow heat exchanger - Outdoor

OPTIONAL ACCESSORIES

ELECTRIC PRE-HEATER

Electric pre-heater		Supply
Air volume	m ³ /h / l/s	4000 / 1111
Maximum heating capacity	kW	15.0
Voltage	V	400
Connection ports	mm	300x300

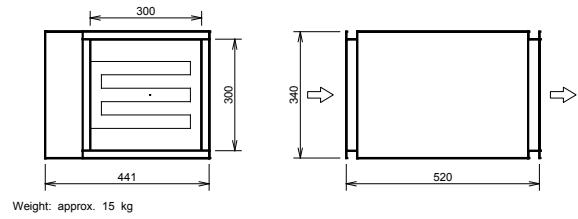

WATER HEATING COIL

Water heating coil		Supply
Heating medium		21% Ethylene glycol
Air volume	m ³ /h / l/s	4000 / 1111
Temperature at inlet (after heat recovery)	°C	17
Temperature at outlet (downstream of the heater)	°C	19
Heating capacity	kW	3.3
Heating medium temperature drop	°C	70/50
Medium flow (from source)	l/h	141
Connection dimension (hydraulic kit)		5/4" female

Note: The figures above have been measured at 4000 m³/h and 200 Pa. Please use the Duplexvent Selection Software to calculate measurements at other performance levels.

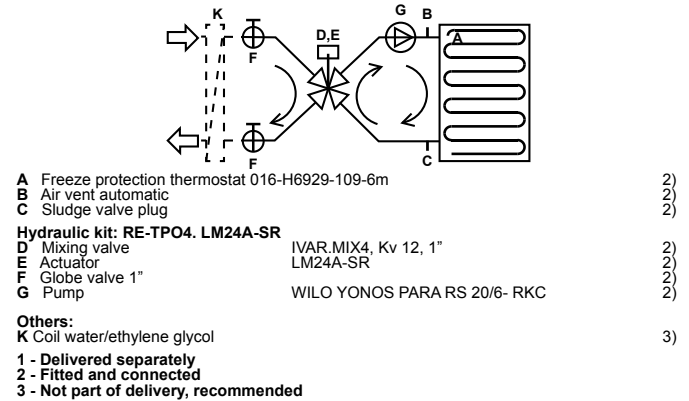

HEATING CAPACITY

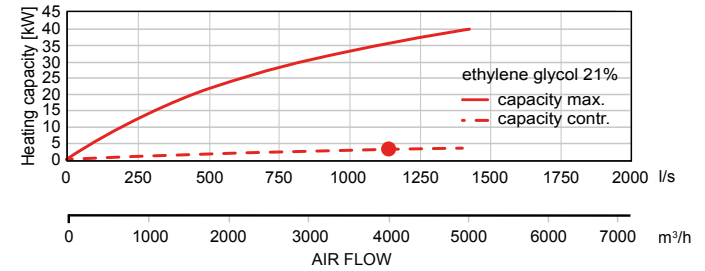

WATER COOLING COIL

Water cooling coil		Supply
Cooling medium		21% Ethylene glycol
Air volume	m ³ /h / l/s	4000 / 1111
Temperature at inlet (after heat recovery)	°C	27
Temperature at outlet (downstream of the cooling coil)	°C	16
Inlet relative humidity (after heat recovery)	% RH	53
Outlet relative humidity (downstream of the cooling coil)	% RH	86
Cooling capacity	kW	21.7
Condensate production	l/h	11
Water temperature drop	°C	6 / 12
Medium flow (at max. capacity)	l/h	3710
Medium-side pressure drop		
in heat exchanger	kPa	26.36
in valve	kPa	13.45
Connection dimension		5/4" female

Note: The figures above have been measured at 4000 m³/h and 200 Pa. Please use the Duplexvent Selection Software to calculate measurements at other performance levels.

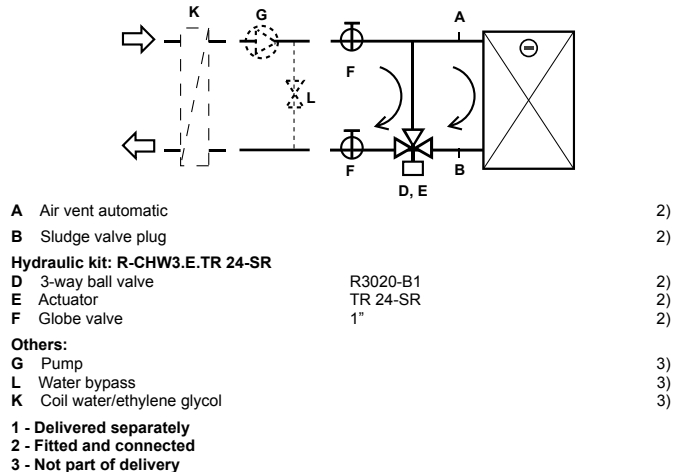

COOLING CAPACITY

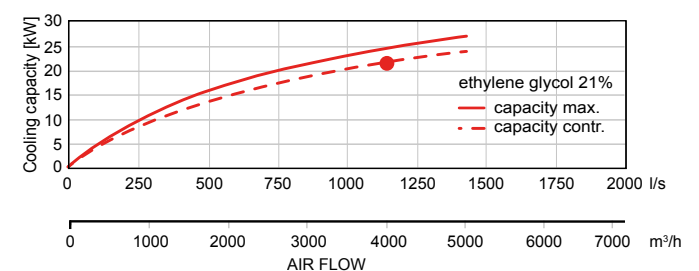

DX COIL

DX coil		Supply
Air volume	m ³ /h / l/s	4000 / 1111
Temperature at inlet (after heat recovery)	°C	27
Temperature at outlet (downstream of the DX coil)	°C	16
Inlet relative humidity (after heat recovery)	% RH	53
Outlet relative humidity (downstream of the DX coil)	% RH	79
Cooling capacity	kW	18.85
Condensate production	l/h	14
Refrigerant type		R410A
Evaporating temperature	°C	10

Note: The figures above have been measured at 4000 m³/h and 200 Pa. Please use the Duplexvent Selection Software to calculate measurements at other performance levels.

COOLING CAPACITY

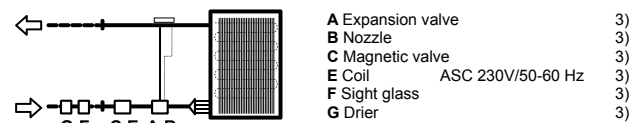
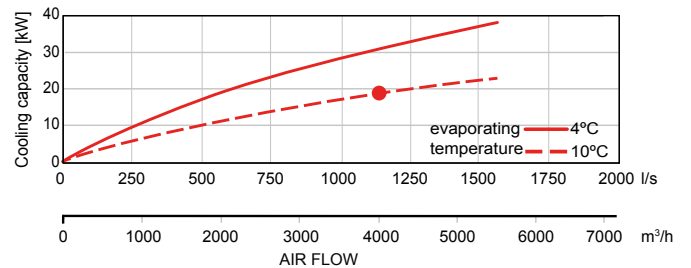

3 Not part of delivery, recommended type mentioned

DIMENSIONS

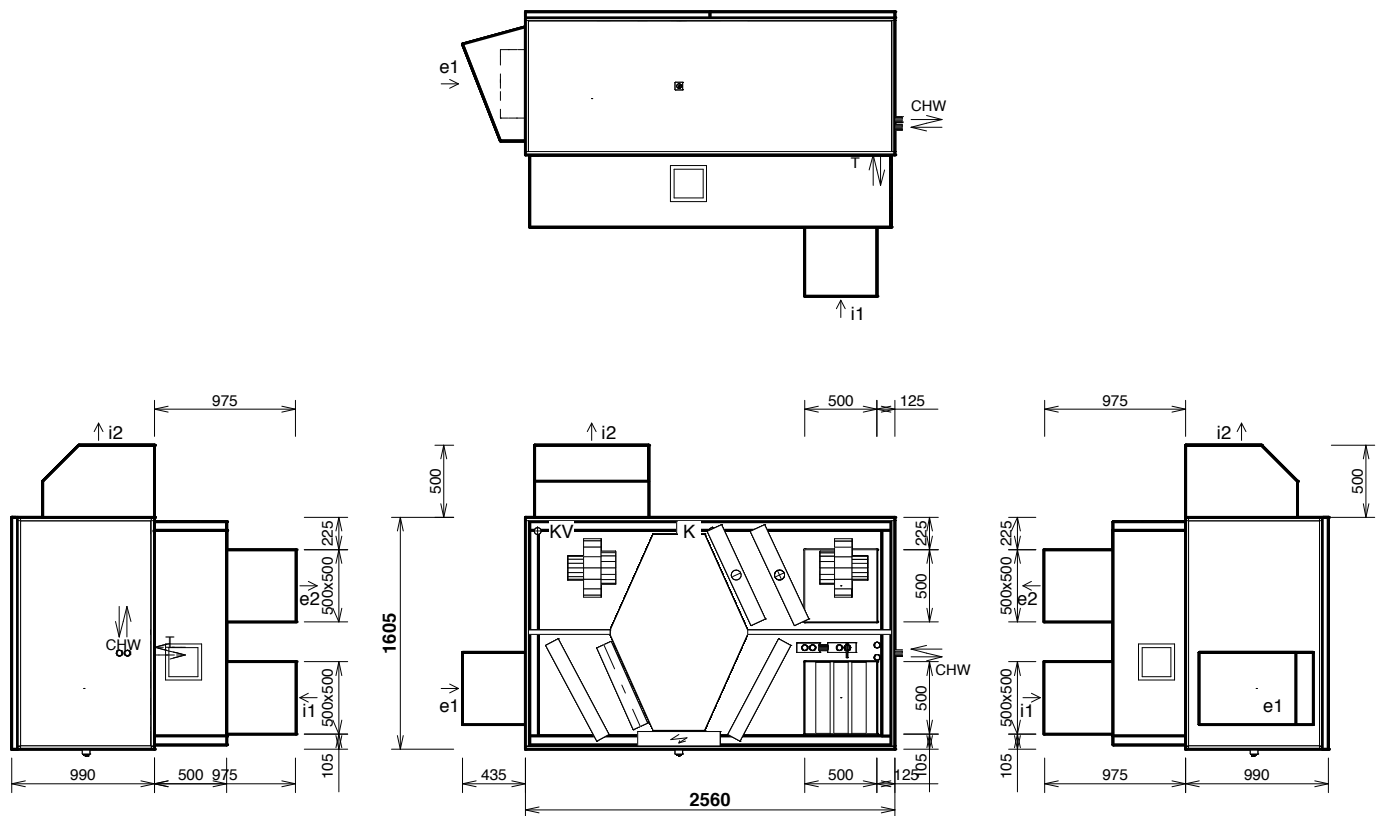

Connections	Type	Dimensions	Optional accessories
e1	e1- outdoor air (ODA)		Shutoff damper, Flexible connection
e2	e2- supply air (SUP)	500x500mm	Flexible connection
i1	i1- extract air (ETA)	500x500mm	Shutoff damper, Flexible connection
i2	i2- exhaust air (EHA)		Flexible connection
K	condensate drain	Ø 32 mm/40 mm	Condensate pump

Notice:

- Terminal strip placed inside a unit
- Diagram is intended only for basic information, binding dimensions receive at device delivery, or on request from the manufacturer
- Bolt holes for duct connection (for one port): 4x M6
- incl: base frame heights 500mm
- Duct extension e2
- Duct extensions i1

Duplexvent Multi eco-Roof DV5500

Commercial MVHR with cross-counter-flow heat exchanger - Outdoor



PERFORMANCE

Ventilation		Supply Air	Extract Air
Air volume @ 300 Pa	m ³ /h / l/s	5000 / 1389	5000 / 1389
Nominal voltage	V	400	400
Nominal power (at operation point)	kW	1.5	1.3
Fan Speed	min ⁻¹	2132	2040
Max power input	kW	3.3	3.3
Max current	A	5.4	5.4
Fan Type		EC	EC

Note: The figures above have been measured at 5000 m³/h and 300 Pa. Please use the Duplexvent Selection Software to calculate measurements at other performance levels.

Heat Recovery		Supply Air	Extract Air
Air volume @ 300 Pa	m ³ /h / l/s	5000 / 1389	5000 / 1389
Temperature at inlet	°C	-5	20
Temperature at outlet	°C	17.3	2.7
Humidity at inlet	% RH	90	40
Humidity at outlet	% RH	18	96
Heat recovery efficiency winter / summer	%	87 / 82	
Performance in winter / summer	kW	37.5 / 8.5	
Condensation	l/h	8.7	
Type of heat exchanger		Cross-counter-flow, Plastic	
Part No.		90000811	

Note: The figures above have been measured at 5000 m³/h and 300 Pa. Please use the Duplexvent Selection Software to calculate measurements at other performance levels.

Sound Power Level L _w	Total	dB (A)							
		63 Hz	125 Hz	250 Hz	500 Hz	1 kHz	2 kHz	4 kHz	8 kHz
Outdoor air e1	67	41	51	64	63	57	48	42	35
Supply air e2	95	74	80	86	92	89	80	72	63
Extract air i1	67	43	50	62	65	53	41	28	<25
Exhaust air i2	93	63	75	85	90	87	79	72	62
Breakout noise	54	31	33	52	48	46	38	33	<25
Sound Pressure Level L _p measured at 3m at inlet e1	47	<25	30	44	43	36	27	<25	<25
Sound Pressure Level L _p measured at 3m at outlet i2	72	43	54	65	70	66	59	51	41
Sound Pressure Level L _p measured at 3m	34	<25	<25	32	27	26	<25	<25	<25

Note: The figures above have been measured at 5000 m³/h and 300 Pa. Please use the Duplexvent Selection Software to calculate measurements at other performance levels.

KEY FEATURES

- Air volume up to 5000 m³/h at 300 Pa according to ErP 2018
- Digital Touchscreen or simple manual controller
- Low noise, refer to NR35 and BB93 standards
- Excellent thermal insulation (class T2, TB1)
- Filters: ePM2,5 65 % (F7), ePM10 70 % (M5) or Coarse 60 % (G4)
- Optional circulation damper
- Optional constant flow and constant pressure mode
- BREEAM and ErP 2018 compliant
- Meets Building Regulations Part L2A and L2B

AIR FLOW CURVE

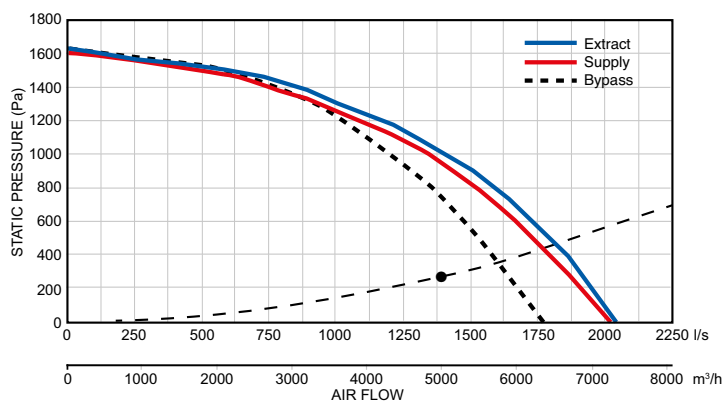

POWER CONSUMPTION

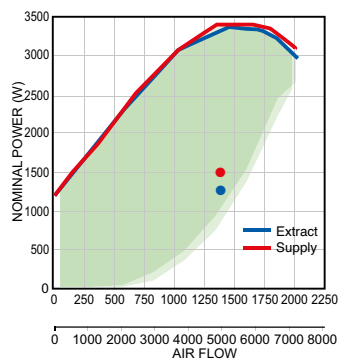

Note: Green area denotes power consumption range. Power consumption depends on system installation.

HEAT RECOVERY EFFICIENCY

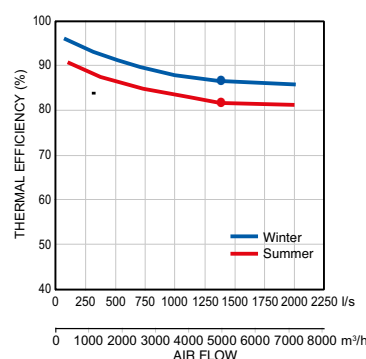

Winter Operation:

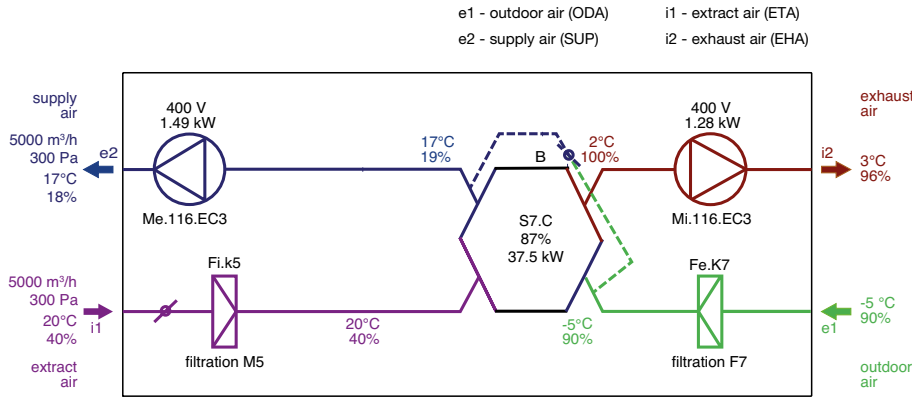

Note: AHU functions diagram. Inlet and outlet location may differ from actual position and port configuration.

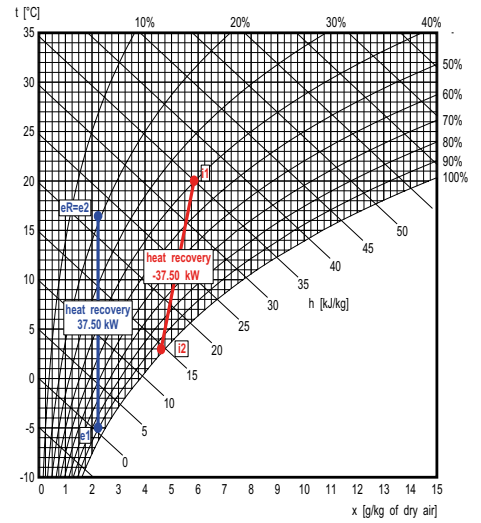

Supply

	Description	t [°C]	RH [%]
e1	Outdoor Air	-5.0	90
e2	Supply Air	17.3	18

Exhaust

	Description	t [°C]	RH [%]
i1	Extract Air	20.0	40
i2	Exhaust Air	2.7	96

Summer Operation:

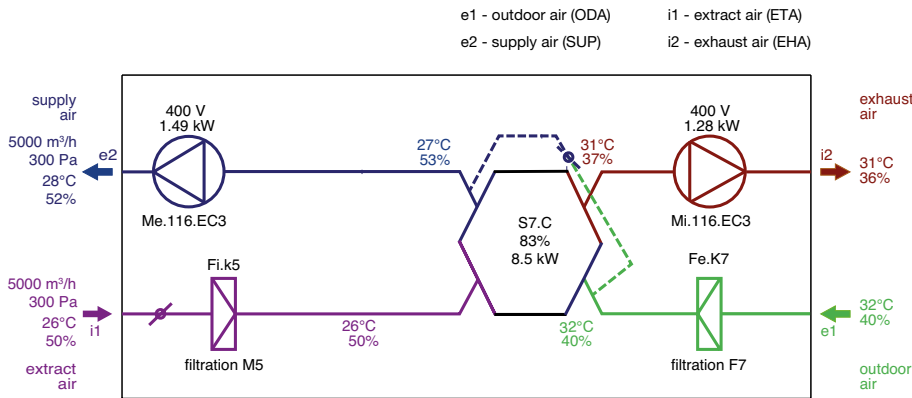

Note: AHU functions diagram. Inlet and outlet location may differ from actual position and port configuration.

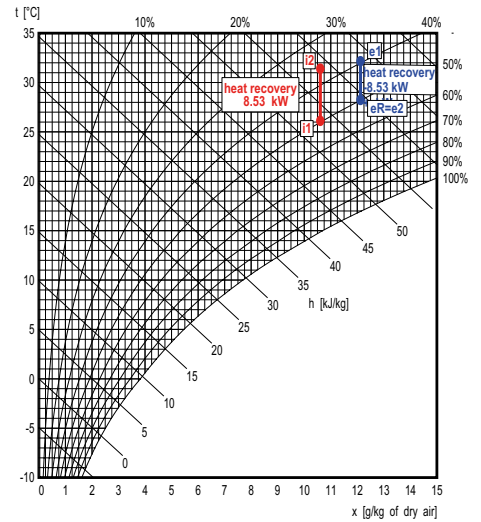

Supply

	Description	t [°C]	RH [%]
e1	Outdoor Air	32.0	40
e2	Supply Air	27.8	51

Exhaust

	Description	t [°C]	RH [%]
i1	Extract Air	26.0	50
i2	Exhaust Air	31.5	36

FILTERS

Filtration	Supply	Extract	Accessories (part of delivery)
Type	Pleated Cartridge		Pfe dirty filter pressure switch for supply air Pfi dirty filter pressure switch for extract air
Filtration class	ePM2,5 65 % (F7)	ePM10 70 % (M5)	
Number of filters	2	2	
Filter cartridge size	750x495x96	750x495x96	

Duplexvent Multi eco-Roof DV5500

Commercial MVHR with cross-counter-flow heat exchanger - Outdoor

OPTIONAL ACCESSORIES

ELECTRIC PRE-HEATER

Electric pre-heater		Supply
Air volume	m ³ /h / l/s	5000 / 1389
Maximum heating capacity	kW	24.0
Voltage	V	400
Connection ports	mm	300x500

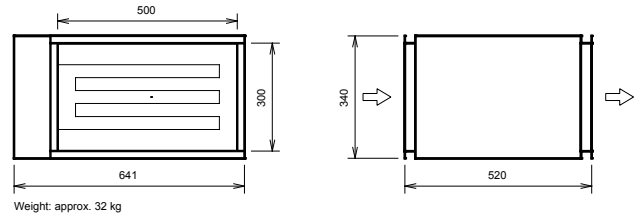

WATER HEATING COIL

Water heating coil		Supply
Heating medium		21% Ethylene glycol
Air volume	m ³ /h / l/s	5000 / 1389
Temperature at inlet (after heat recovery)	°C	17
Temperature at outlet (downstream of the heater)	°C	19
Heating capacity	kW	4.2
Heating medium temperature drop	°C	70/50
Medium flow (from source)	l/h	183
Connection dimension (hydraulic kit)		5/4" female

Note: The figures above have been measured at 5000 m³/h and 300 Pa. Please use the Duplexvent Selection Software to calculate measurements at other performance levels.

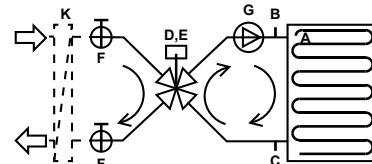

- A Freeze protection thermostat 016-H6929-109-6m
 - B Air vent automatic
 - C Sludge valve plug
 - Hydraulic kit: RE-TPO4. LM24A-SR
 - D Mixing valve
 - E Actuator
 - F Globe valve 1"
 - G Pump
- Others:
- K Coil water/ethylene glycol
- 1 - Delivered separately
2 - Fitted and connected
3 - Not part of delivery, recommended

HEATING CAPACITY

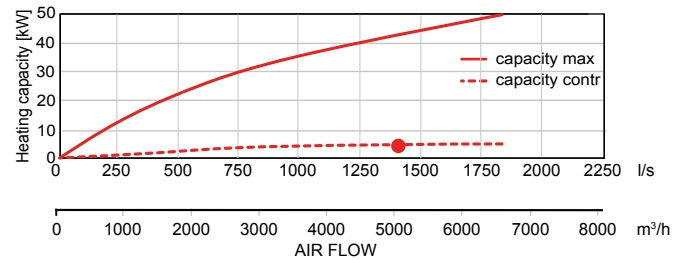

WATER COOLING COIL

Water cooling coil		Supply
Cooling medium		21% Ethylene glycol
Air volume	m ³ /h / l/s	5000 / 1389
Temperature at inlet (after heat recovery)	°C	27
Temperature at outlet (downstream of the cooling coil)	°C	16
Inlet relative humidity (after heat recovery)	% RH	53
Outlet relative humidity (downstream of the cooling coil)	% RH	88
Cooling capacity	kW	26.8
Condensate production	l/h	12
Water temperature drop	°C	6 / 12
Medium flow (at max. capacity)	l/h	4350
Medium-side pressure drop		
in heat exchanger	kPa	20.24
in valve	kPa	18.49
Connection dimension		5/4" female

Note: The figures above have been measured at 5000 m³/h and 300 Pa. Please use the Duplexvent Selection Software to calculate measurements at other performance levels.

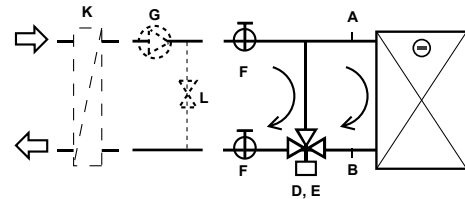

- A Air vent automatic
 - B Sludge valve plug
 - Hydraulic kit: R-CHW3.E.TR 24-SR
 - D 3-way ball valve
 - E Actuator
 - F Globe valve
 - G Pump
 - L Water bypass
 - K Coil water/ethylene glycol
- Others:
- R3020-B1
 - TR 24-SR
 - 1"
- 1 - Delivered separately
2 - Fitted and connected
3 - Not part of delivery

COOLING CAPACITY

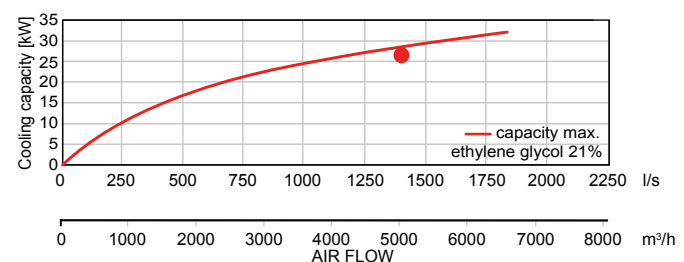

DX COIL

DX coil		Supply
Air volume	m ³ /h / l/s	5000 / 1389
Temperature at inlet (after heat recovery)	°C	27
Temperature at outlet (downstream of the DX coil)	°C	16
Inlet relative humidity (after heat recovery)	% RH	53
Outlet relative humidity (downstream of the DX coil)	% RH	79
Cooling capacity	kW	25.26
Condensate production	l/h	18
Refrigerant type		R410A
Evaporating temperature	°C	9

Note: The figures above have been measured at 5000 m³/h and 300 Pa. Please use the Duplexvent Selection Software to calculate measurements at other performance levels.

COOLING CAPACITY

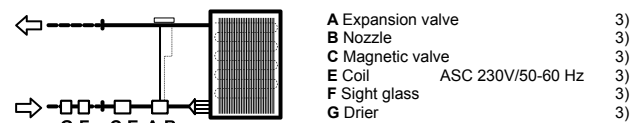
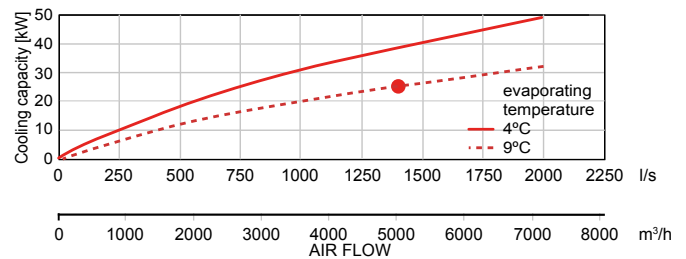

3 Not part of delivery, recommended type mentioned

DIMENSIONS

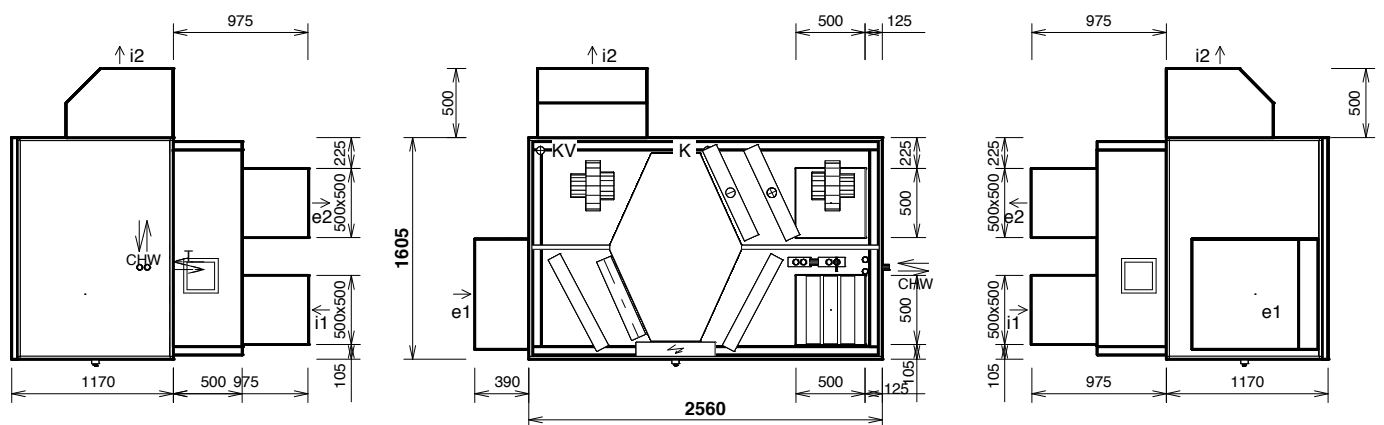
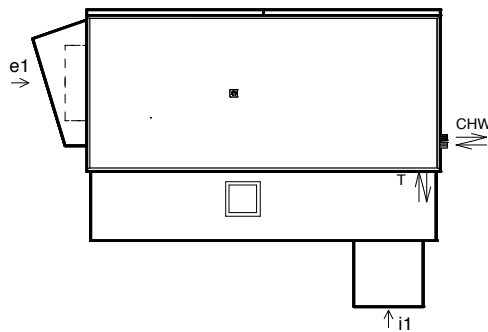

Connections	Type	Dimensions	Optional components
e1	e1- outdoor air (ODA)		Shutoff damper, Flexible connection
e2	e2- supply air (SUP)	500x500mm	Flexible connection
i1	i1- extract air (ETA)	500x500mm	Shutoff damper, Flexible connection
i2	i2- exhaust air (EHA)		Flexible connection
K	condensate drain	Ø 32 mm/40 mm	Condensate pump

Notice:

- Terminal strip placed inside a unit
- Diagram is intended only for basic information, binding dimensions receive at device delivery, or on request from the manufacturer
- Bolt holes for duct connection (for one port): 4x M6
- incl: base frame heights 500mm
- Duct extension e2
- Duct extensions i1

Duplexvent Multi eco-Roof DV6500

Commercial MVHR with cross-counter-flow heat exchanger - Outdoor



PERFORMANCE

Ventilation		Supply Air	Extract Air
Air volume @ 300 Pa	m ³ /h / l/s	5500 / 1528	5500 / 1528
Nominal voltage	V	400	400
Nominal power (at operation point)	kW	1.8	1.5
Fan Speed	min ⁻¹	2252	2155
Max power input	kW	3.3	3.3
Max current	A	5.4	5.4
Fan Type		EC	EC

Note: The figures above have been measured at 5500 m³/h and 300 Pa. Please use the Duplexvent Selection Software to calculate measurements at other performance levels.

Heat Recovery		Supply Air	Extract Air
Air volume @ 300 Pa	m ³ /h / l/s	5500 / 1528	5500 / 1528
Temperature at inlet	°C	-5	20
Temperature at outlet	°C	17.5	2.7
Humidity at inlet	% RH	90	40
Humidity at outlet	% RH	18	96
Heat recovery efficiency winter / summer	%	87 / 82	
Performance in winter / summer	kW	41.4 / 9.4	
Condensation	l/h	9.7	
Type of heat exchanger		Cross-counter-flow, Plastic	
Part No.		90000812	

Note: The figures above have been measured at 5500 m³/h and 300 Pa. Please use the Duplexvent Selection Software to calculate measurements at other performance levels.

Sound Power Level L _w	Total	63 Hz	125 Hz	250 Hz	500 Hz	1 kHz	2 kHz	4 kHz	8 kHz
	dB (A)								
Outdoor air e1	65	37	49	62	61	57	45	36	28
Supply air e2	93	70	76	84	89	89	82	74	63
Extract air i1	66	40	47	56	62	62	55	48	42
Exhaust air i2	86	57	71	82	83	75	64	47	37
Breakout noise	65	44	49	60	59	57	57	52	41
Sound Pressure Level L _p measured at 3m at inlet e1	45	<25	29	41	40	36	<25	<25	<25
Sound Pressure Level L _p measured at 3m at outlet i2	66	37	51	62	62	55	43	26	<25
Sound Pressure Level L _p measured at 3m	44	<25	28	39	39	37	36	32	<25

Note: The figures above have been measured at 5500 m³/h and 300 Pa. Please use the Duplexvent Selection Software to calculate measurements at other performance levels.

KEY FEATURES

- Air volume up to 5500 m³/h at 300 Pa according to ErP 2018
- Digital Touchscreen or simple manual controller
- Low noise, refer to NR35 and BB93 standards
- Excellent thermal insulation (class T2, TB1)
- Filters: ePM2,5 65 % (F7), ePM10 70 % (M5) or Coarse 60 % (G4)
- Optional circulation damper
- Optional constant flow and constant pressure mode
- BREEAM and ErP 2018 compliant
- Meets Building Regulations Part L2A and L2B

AIR FLOW CURVE

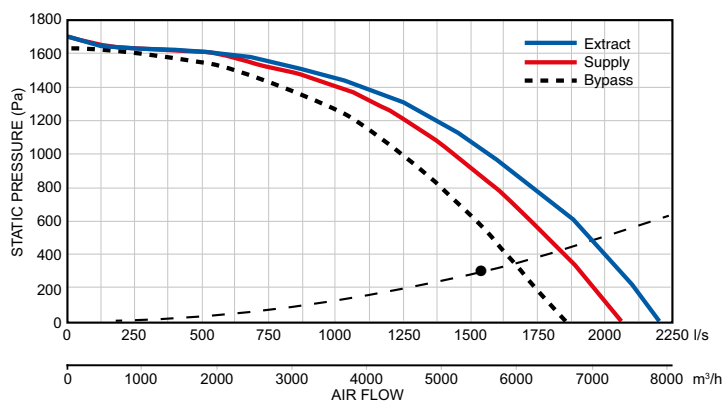

POWER CONSUMPTION

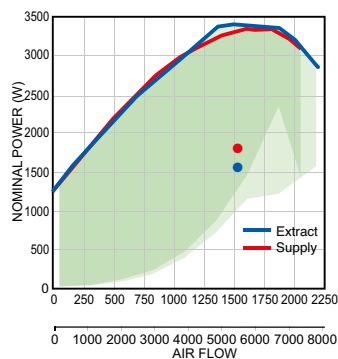

Note: Green area denotes power consumption range. Power consumption depends on system installation.

HEAT RECOVERY EFFICIENCY

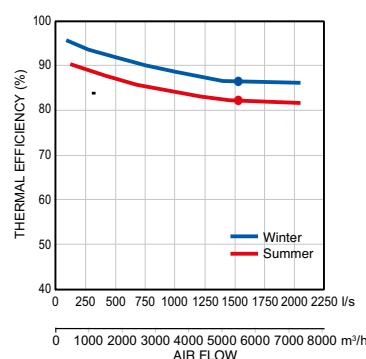

Winter Operation:

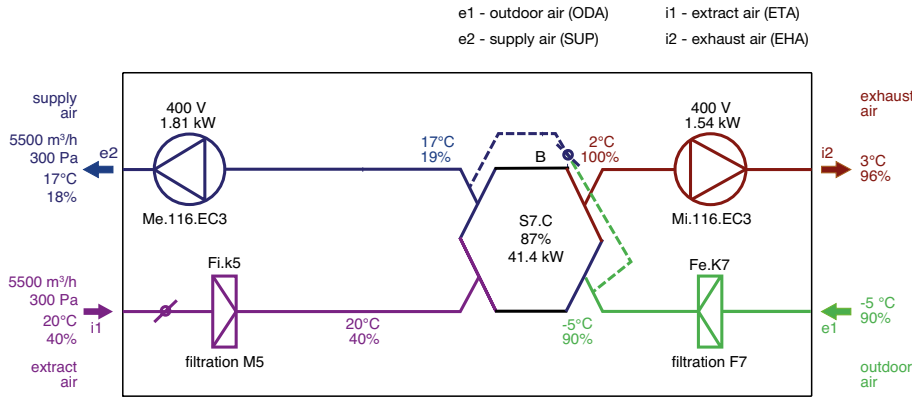

Note: AHU functions diagram. Inlet and outlet location may differ from actual position and port configuration.

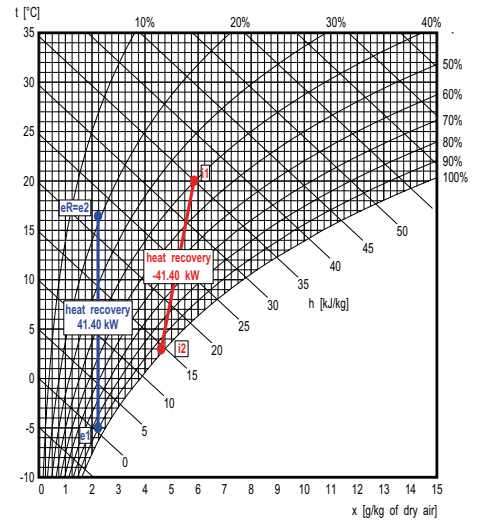

Supply

	Description	t [°C]	RH [%]
e1	Outdoor Air	-5.0	90
e2	Supply Air	17.5	18

Exhaust

	Description	t [°C]	RH [%]
i1	Extract Air	20.0	40
i2	Exhaust Air	2.7	96

Summer Operation:

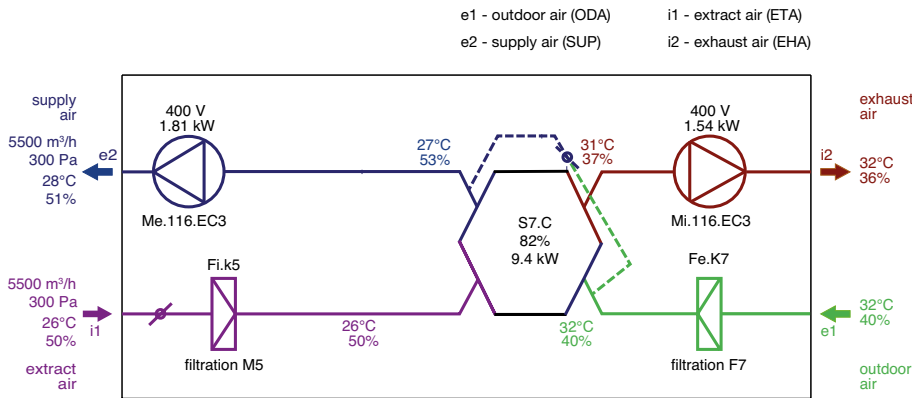

Note: AHU functions diagram. Inlet and outlet location may differ from actual position and port configuration.

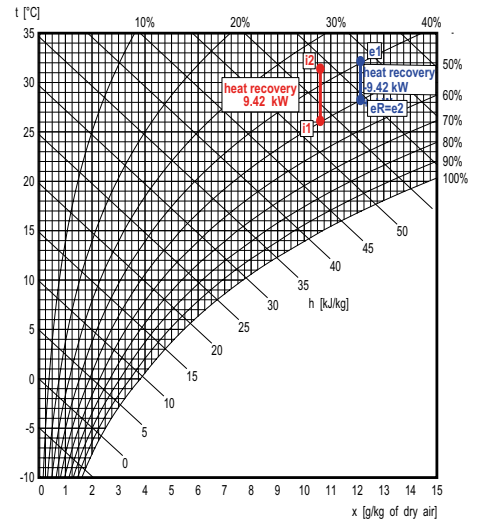

Supply

	Description	t [°C]	RH [%]
e1	Outdoor Air	32.0	40
e2	Supply Air	27.9	51

Exhaust

	Description	t [°C]	RH [%]
i1	Extract Air	26.0	50
i2	Exhaust Air	31.6	36

FILTERS

Filtration	Supply	Extract	Accessories (part of delivery)
Type	Pleated Cartridge		Pfe dirty filter pressure switch for supply air Pfi dirty filter pressure switch for extract air
Filtration class	ePM2,5 65 % (F7)	ePM10 70 % (M5)	
Number of filters	pcs 3	3	
Filter cartridge size	mm 750x405x96	750x405x96	

Duplexvent Multi eco-Roof DV6500

Commercial MVHR with cross-counter-flow heat exchanger - Outdoor

OPTIONAL ACCESSORIES

ELECTRIC PRE-HEATER

Electric pre-heater		Supply
Air volume	m ³ /h / l/s	5500 / 1528
Maximum heating capacity	kW	54.0
Voltage	V	400
Connection ports	mm	500x800

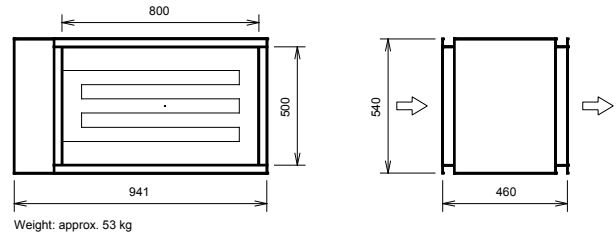

WATER HEATING COIL

Water heating coil		Supply
Heating medium		21% Ethylene glycol
Air volume	m ³ /h / l/s	5500 / 1528
Temperature at inlet (after heat recovery)	°C	17
Temperature at outlet (downstream of the heater)	°C	19
Heating capacity	kW	4.7
Heating medium temperature drop	°C	70/50
Medium flow (from source)	l/h	200
Connection dimension (hydraulic kit)		5/4" female

Note: The figures above have been measured at 5500 m³/h and 300 Pa. Please use the Duplexvent Selection Software to calculate measurements at other performance levels.

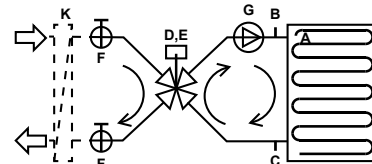

- A Freeze protection thermostat 016-H6929-109-6m
 - B Air vent automatic
 - C Sludge valve plug
 - Hydraulic kit: RE-TPO4. LM24A-SR**
 - D Mixing valve
 - E Actuator
 - F Globe valve 1"
 - G Pump
- Others:
- K Coil water/ethylene glycol
- 1 - Delivered separately
2 - Fitted and connected
3 - Not part of delivery, recommended

HEATING CAPACITY

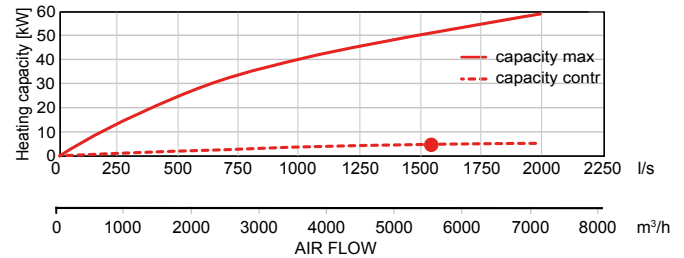

WATER COOLING COIL

Water cooling coil		Supply
Cooling medium		21% Ethylene glycol
Air volume	m ³ /h / l/s	5500 / 1528
Temperature at inlet (after heat recovery)	°C	27
Temperature at outlet (downstream of the cooling coil)	°C	16
Inlet relative humidity (after heat recovery)	% RH	53
Outlet relative humidity (downstream of the cooling coil)	% RH	85
Cooling capacity	kW	30.3
Condensate production	l/h	15
Water temperature drop	°C	6 / 12
Medium flow (at max. capacity)	l/h	4570
Medium-side pressure drop		
in heat exchanger	kPa	55.59
in valve	kPa	20.42
Connection dimension		5/4" female

Note: The figures above have been measured at 5500 m³/h and 300 Pa. Please use the Duplexvent Selection Software to calculate measurements at other performance levels.

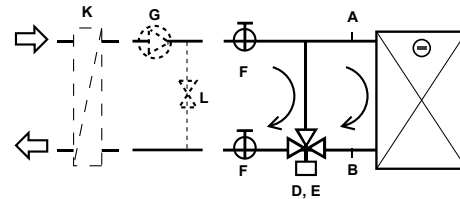

- A Air vent automatic
 - B Sludge valve plug
 - Hydraulic kit: R-CHW3.E.TR 24-SR**
 - D 3-way ball valve
 - E Actuator
 - F Globe valve
 - G Pump
 - L Water bypass
 - K Coil water/ethylene glycol
- Others:
- 1 - Delivered separately
 - 2 - Fitted and connected
 - 3 - Not part of delivery

COOLING CAPACITY

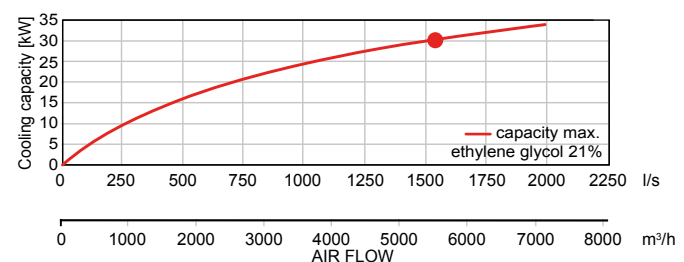

DX COIL

DX coil		Supply
Air volume	m ³ /h / l/s	5500 / 1528
Temperature at inlet (after heat recovery)	°C	27
Temperature at outlet (downstream of the DX coil)	°C	16
Inlet relative humidity (after heat recovery)	% RH	53
Outlet relative humidity (downstream of the DX coil)	% RH	80
Cooling capacity	kW	26.82
Condensate production	l/h	19
Refrigerant type		R410A
Evaporating temperature	°C	10

Note: The figures above have been measured at 5500 m³/h and 300 Pa. Please use the Duplexvent Selection Software to calculate measurements at other performance levels.

COOLING CAPACITY

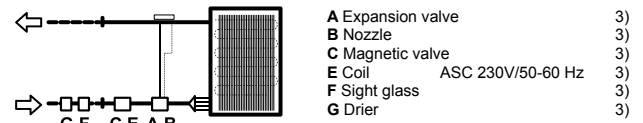
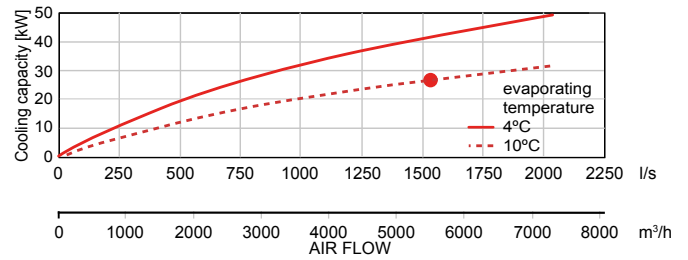

3 Not part of delivery, recommended type mentioned

DIMENSIONS

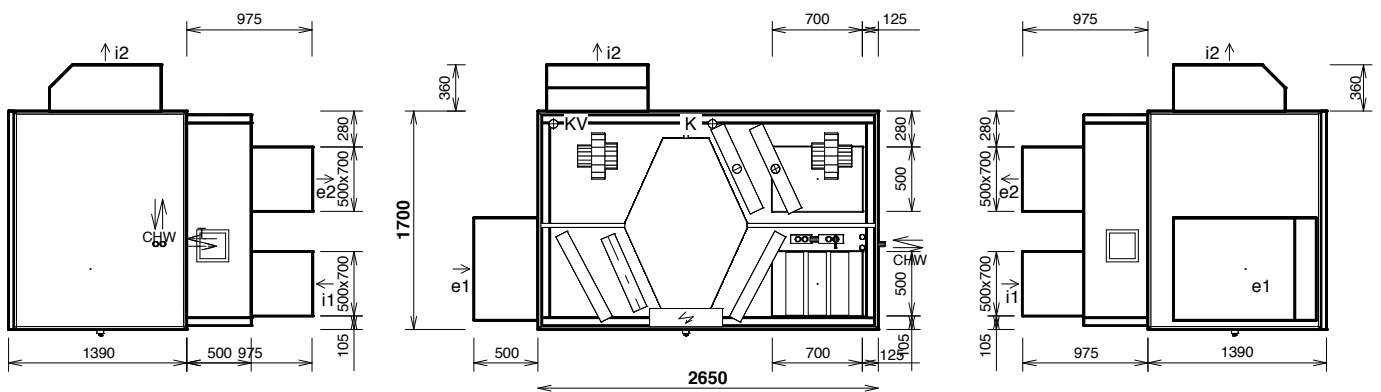
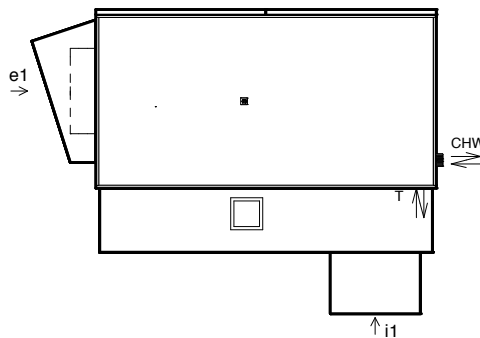

Connections	Type	Dimensions	Optional accessories
e1	e1- outdoor air (ODA)		Shutoff damper, Flexible connection
e2	e2- supply air (SUP)	700x500mm	Flexible connection
i1	i1- extract air (ETA)	700x500mm	Shutoff damper, Flexible connection
i2	i2- exhaust air (EHA)		Flexible connection
K	condensate drain	Ø 32 mm/40 mm	Condensate pump

Notice:

- Terminal strip placed inside a unit
- Diagram is intended only for basic information, binding dimensions receive at device delivery, or on request from the manufacturer
- Bolt holes for duct connection (for one port): 4x M6
- incl: base frame heights 500mm
Duct extension e2
Duct extensions i1

Duplexvent Multi eco-Roof DV7500

Commercial MVHR with cross-counter-flow heat exchanger - Outdoor



PERFORMANCE

Ventilation		Supply Air	Extract Air
Air volume @ 300 Pa	m ³ /h / l/s	6500 / 1806	6500 / 1806
Nominal voltage	V	400	400
Nominal power (at operation point)	kW	2.1	1.8
Fan Speed	min ⁻¹	2332	2275
Max power input	kW	3.3	3.3
Max current	A	5.4	5.4
Fan Type		EC	EC

Note: The figures above have been measured at 6500 m³/h and 300 Pa. Please use the Duplexvent Selection Software to calculate measurements at other performance levels.

Heat Recovery		Supply Air	Extract Air
Air volume @ 300 Pa	m ³ /h / l/s	6500 / 1806	6500 / 1806
Temperature at inlet	°C	-5	20
Temperature at outlet	°C	17	2
Humidity at inlet	% RH	90	40
Humidity at outlet	% RH	19	100
Heat recovery efficiency winter / summer	%	87 / 83	
Performance in winter / summer	kW	49.1 / 11.2	
Condensation	l/h	11.6	
Type of heat exchanger		Cross-counter-flow, Plastic	
Part No.		90000813	

Note: The figures above have been measured at 6500 m³/h and 300 Pa. Please use the Duplexvent Selection Software to calculate measurements at other performance levels.

Sound Power Level L _w	Total	63 Hz	125 Hz	250 Hz	500 Hz	1 kHz	2 kHz	4 kHz	8 kHz
	dB (A)								
Outdoor air e1	63	46	47	53	59	58	49	46	36
Supply air e2	89	53	59	74	80	85	83	78	73
Extract air i1	66	43	38	61	62	59	51	39	27
Exhaust air i2	89	71	71	77	84	84	79	74	70
Breakout noise	70	45	53	70	57	53	48	45	45
Sound Pressure Level L_p measured at 3m at inlet e1	42	25	27	33	38	37	28	26	<25
Sound Pressure Level L_p measured at 3m	50	25	32	49	37	32	28	25	25

Note: The figures above have been measured at 6500 m³/h and 300 Pa. Please use the Duplexvent Selection Software to calculate measurements at other performance levels.

KEY FEATURES

- Air volume up to 6500 m³/h at 300 Pa according to ErP 2018
- Digital Touchscreen or simple manual controller
- Low noise, refer to NR35 and BB93 standards
- Excellent thermal insulation (class T2, TB1)
- Filters: ePM2,5 65 % (F7), ePM10 70 % (M5) or Coarse 60 % (G4)
- Optional circulation damper
- Optional constant flow and constant pressure mode
- BREEAM and ErP 2018 compliant
- Meets Building Regulations Part L2A and L2B

AIR FLOW CURVE

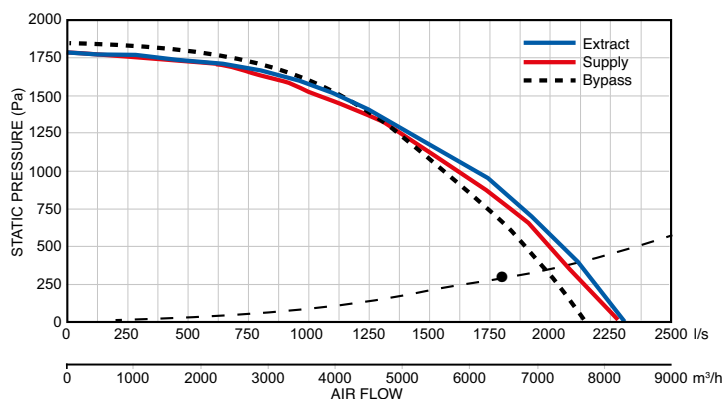

POWER CONSUMPTION

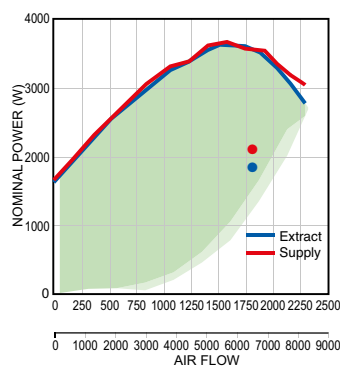

Note: Green area denotes power consumption range. Power consumption depends on system installation.

HEAT RECOVERY EFFICIENCY

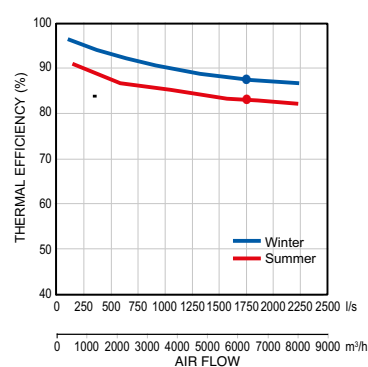

Winter Operation:

e1 - outdoor air (ODA) i1 - extract air (ETA)
 e2 - supply air (SUP) i2 - exhaust air (EHA)

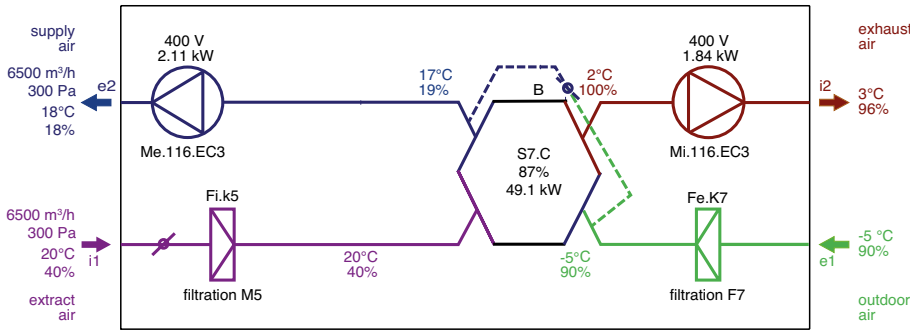

Note: AHU functions diagram. Inlet and outlet location may differ from actual position and port configuration.

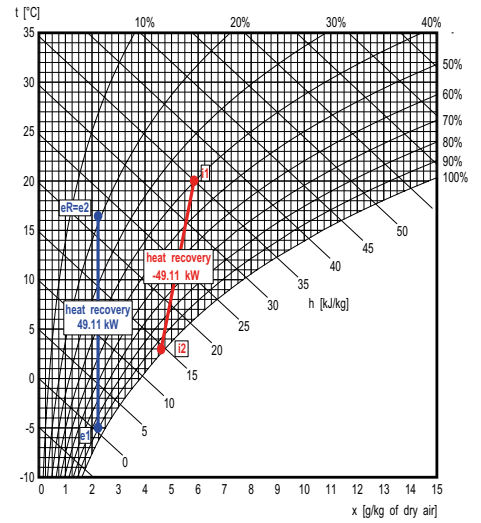

Supply

Description	t [°C]	RH [%]
e1 Outdoor Air	-5.0	90
e2 Supply Air	17.5	18

Exhaust

Description	t [°C]	RH [%]
i1 Extract Air	26.0	50
i2 Exhaust Air	2.6	96

Summer Operation:

e1 - outdoor air (ODA) i1 - extract air (ETA)
 e2 - supply air (SUP) i2 - exhaust air (EHA)

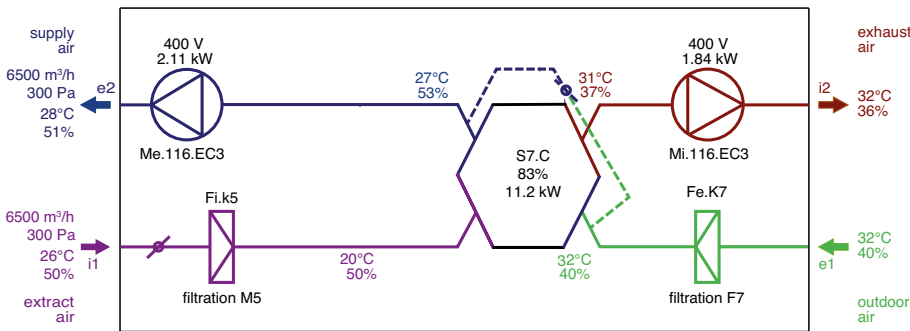

Note: AHU functions diagram. Inlet and outlet location may differ from actual position and port configuration.

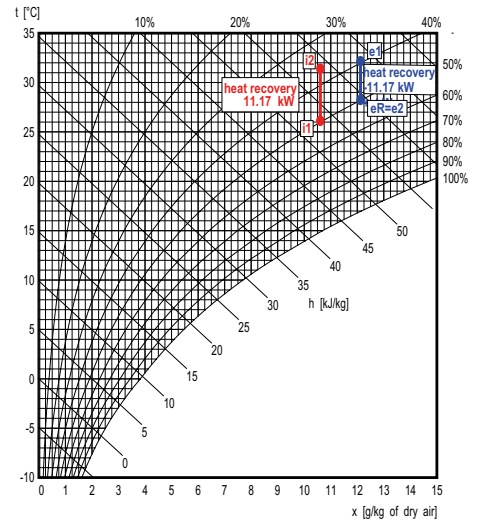

Supply

Description	t [°C]	RH [%]
e1 Outdoor Air	32.0	40
e2 Supply Air	27.9	51

Exhaust

Description	t [°C]	RH [%]
i1 Extract Air	26.0	50
i2 Exhaust Air	31.6	36

FILTERS

Filtration Type	Supply	Extract	Accessories (part of delivery)
	Pleated Cartridge		
Filtration class	ePM2,5 65 % (F7)	ePM10 70 % (M5)	Pfe dirty filter pressure switch for supply air
Number of filters	1+3	1+3	Pfi dirty filter pressure switch for extract air
Filter cartridge size	750x295x96 750x405x96	750x295x96 750x405x96	

Duplexvent Multi eco-Roof DV7500

Commercial MVHR with cross-counter-flow heat exchanger - Outdoor

OPTIONAL ACCESSORIES

ELECTRIC PRE-HEATER

Electric pre-heater		Supply
Air volume	m ³ /h / l/s	6500 / 1806
Maximum heating capacity	kW	54.0
Voltage	V	400
Connection ports	mm	500x800

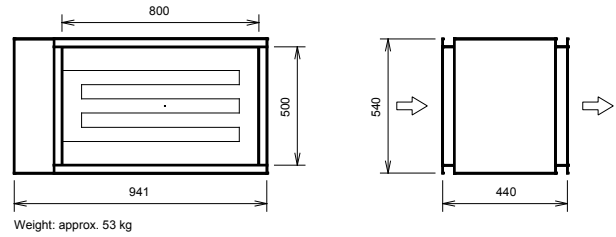

WATER HEATING COIL

Water heating coil		Supply
Heating medium		21% Ethylene glycol
Air volume	m ³ /h / l/s	6500 / 1806
Temperature at inlet (after heat recovery)	°C	17
Temperature at outlet (downstream of the heater)	°C	19
Heating capacity	kW	5.2
Heating medium temperature drop	°C	70/50
Medium flow (from source)	l/h	226
Connection dimension (hydraulic kit)		5/4" female

Note: The figures above have been measured at 6500 m³/h and 300 Pa. Please use the Duplexvent Selection Software to calculate measurements at other performance levels.

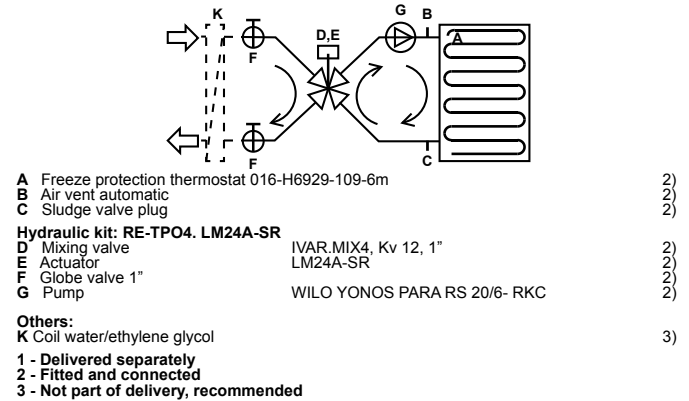

HEATING CAPACITY

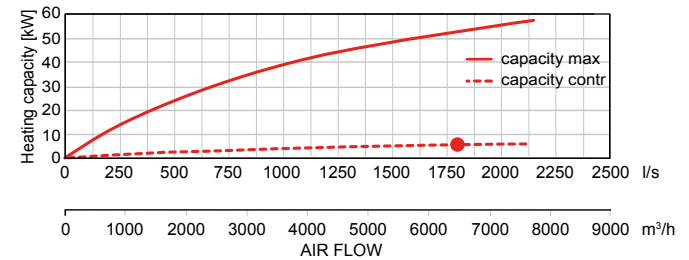

WATER COOLING COIL

Water cooling coil		Supply
Cooling medium		21% Ethylene glycol
Air volume	m ³ /h / l/s	6500 / 1806
Temperature at inlet (after heat recovery)	°C	27
Temperature at outlet (downstream of the cooling coil)	°C	18
Inlet relative humidity (after heat recovery)	% RH	53
Outlet relative humidity (downstream of the cooling coil)	% RH	94
Cooling capacity	kW	22.9
Condensate production	l/h	3
Water temperature drop	°C	6 / 12
Medium flow (at max. capacity)	l/h	3460
Medium-side pressure drop		
in heat exchanger	kPa	3.65
in valve	kPa	11.7
Connection dimension		5/4" female

Note: The figures above have been measured at 6500 m³/h and 300 Pa. Please use the Duplexvent Selection Software to calculate measurements at other performance levels.

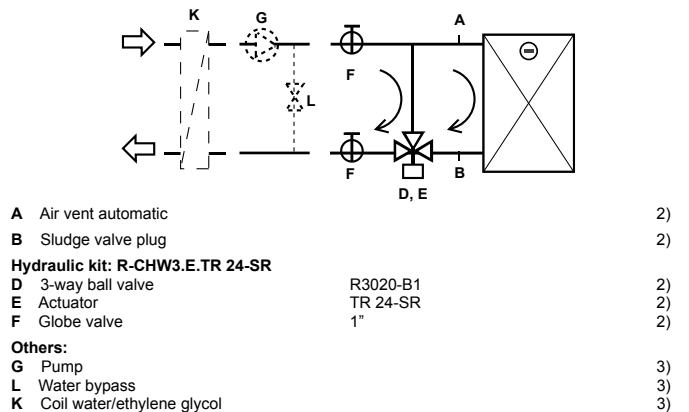

COOLING CAPACITY

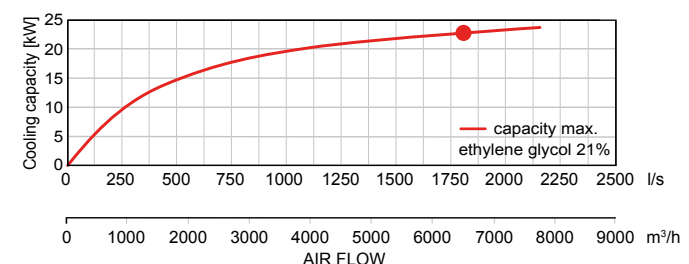

DX COIL

DX coil		Supply
Air volume	m ³ /h / l/s	6500 / 1806
Temperature at inlet (after heat recovery)	°C	27
Temperature at outlet (downstream of the DX coil)	°C	18
Inlet relative humidity (after heat recovery)	% RH	53
Outlet relative humidity (downstream of the DX coil)	% RH	78
Cooling capacity	kW	32.10
Condensate production	l/h	18
Refrigerant type		R410A
Evaporating temperature	°C	5

Note: The figures above have been measured at 6500 m³/h and 300 Pa. Please use the Duplexvent Selection Software to calculate measurements at other performance levels.

COOLING CAPACITY

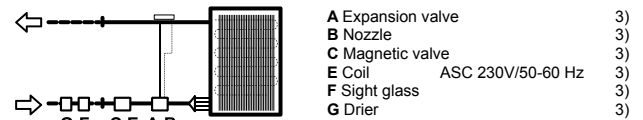
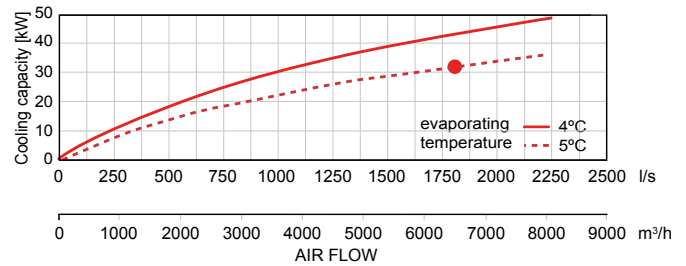

- A Expansion valve (3)
- B Nozzle (3)
- C Magnetic valve (3)
- E Coil ASC 230V/50-60 Hz (3)
- F Sight glass (3)
- G Drier (3)

3 Not part of delivery, recommended type mentioned

DIMENSIONS

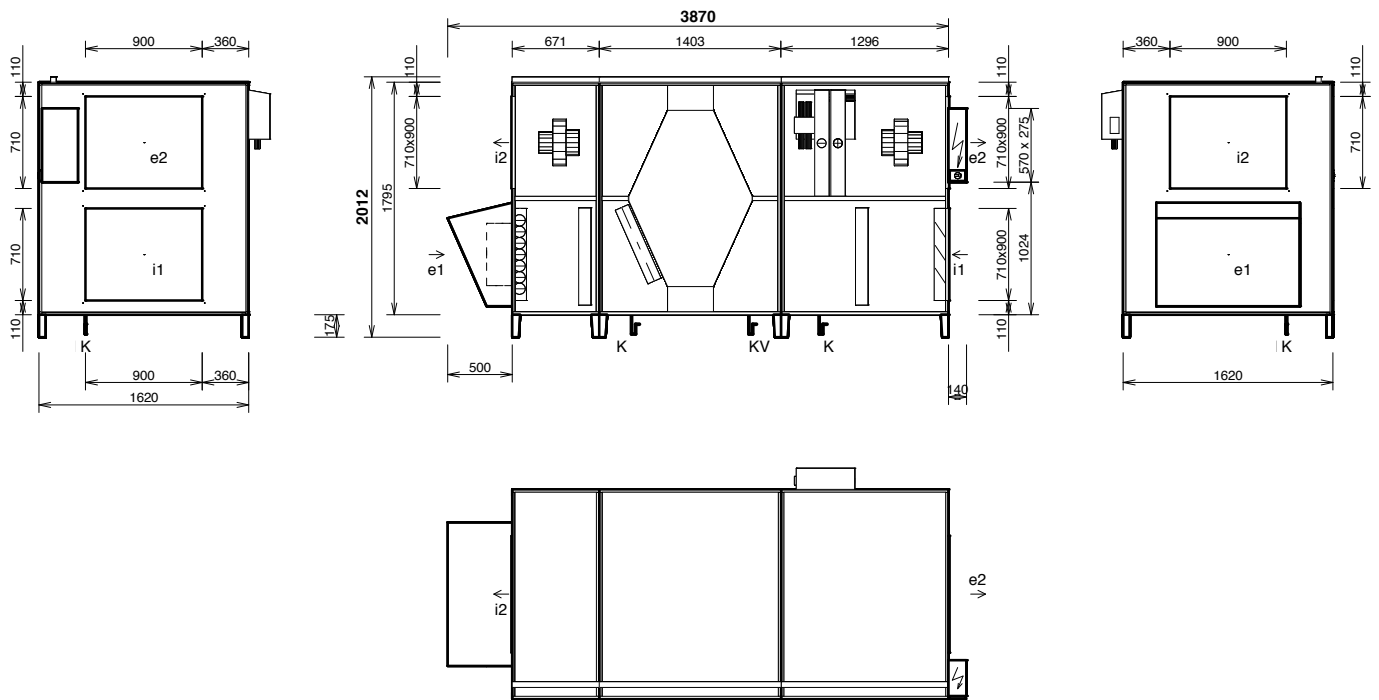

Connections	Type	Dimensions	Optional Components
e1	e1- outdoor air (ODA)		Shutoff damper, Flexible connection
e2	e2- supply air (SUP)	710x900mm	Flexible connection
i1	i1- extract air (ETA)	710x900mm	Shutoff damper, Flexible connection
i2	i2- exhaust air (EHA)	710x900mm	Flexible connection
K	condensate drain	2 x Ø 32 mm/40 mm	Condensate pump

Notice:

- Unit supplied in three pieces
- Diagram is intended only for basic information, binding dimensions receive at device delivery, or on request from the manufacturer
- Bolt holes for duct connection (for one port): 4x M6

Duplexvent Multi eco-Roof DV9000

Commercial MVHR with cross-counter-flow heat exchanger - Outdoor



PERFORMANCE

Ventilation		Supply Air	Extract Air
Air volume @ 400 Pa	m ³ /h / l/s	8000 / 2222	8000 / 2222
Nominal voltage	V	400	400
Nominal power (at operation point)	kW	3.2	2.6
Fan Speed	min ⁻¹	2197	2125
Max power input	kW	5.2	5.2
Max current	A	8.4	8.4
Fan Type		EC	EC

Note: The figures above have been measured at 8000 m³/h and 400 Pa. Please use the Duplexvent Selection Software to calculate measurements at other performance levels.

Heat Recovery		Supply Air	Extract Air
Air volume @ 400 Pa	m ³ /h / l/s	8000 / 2222	8000 / 2222
Temperature at inlet	°C	-5	20
Temperature at outlet	°C	17.8	2.7
Humidity at inlet	% RH	90	40
Humidity at outlet	% RH	18	95
Heat recovery efficiency winter / summer	%	88 / 83	
Performance in winter / summer	kW	60.6 / 13.6	
Condensation	l/h	14.4	
Type of heat exchanger		Cross-counter-flow, Plastic	
Part No.		90000814	

Note: The figures above have been measured at 8000 m³/h and 400 Pa. Please use the Duplexvent Selection Software to calculate measurements at other performance levels.

Sound Power Level L _w	Total	63 Hz	125 Hz	250 Hz	500 Hz	1 kHz	2 kHz	4 kHz	8 kHz
dB (A)									
Outdoor air e1	63	32	40	53	55	61	48	43	29
Supply air e2	99	71	82	89	95	95	88	82	73
Extract air i1	63	35	44	53	60	60	46	30	<25
Exhaust air i2	97	67	77	84	92	94	87	79	72
Breakout noise	69	47	52	64	63	64	60	56	47
Sound Pressure Level L _p measured at 3m at inlet e1	43	<25	<25	32	35	41	27	<25	<25
Sound Pressure Level L _p measured at 3m	49	26	31	44	43	43	39	35	27

Note: The figures above have been measured at 8000 m³/h and 400 Pa. Please use the Duplexvent Selection Software to calculate measurements at other performance levels.

KEY FEATURES

- Air volume up to 8000 m³/h at 400 Pa according to ErP 2018
- Digital Touchscreen or simple manual controller
- Low noise, refer to NR35 and BB93 standards
- Excellent thermal insulation (class T2, TB1)
- Filters: ePM2,5 65 % (F7), ePM10 70 % (M5) or Coarse 60 % (G4)
- Optional circulation damper
- Optional constant flow and constant pressure mode
- BREEAM and ErP 2018 compliant
- Meets Building Regulations Part L2A and L2B

AIR FLOW CURVE

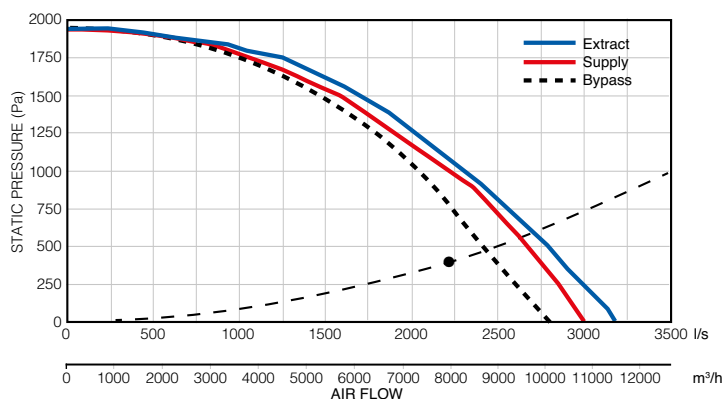

POWER CONSUMPTION

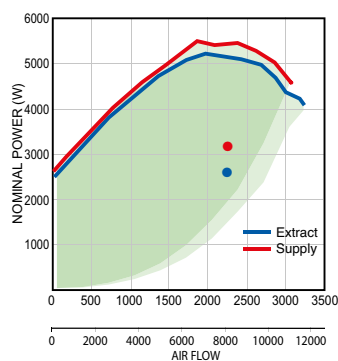

Note: Green area denotes power consumption range. Power consumption depends on system installation.

HEAT RECOVERY EFFICIENCY

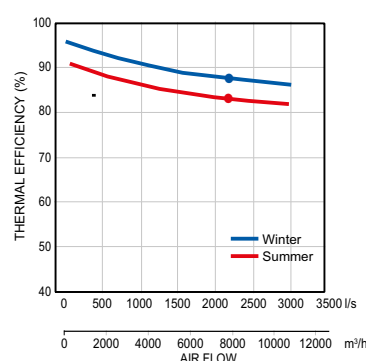

Winter Operation:

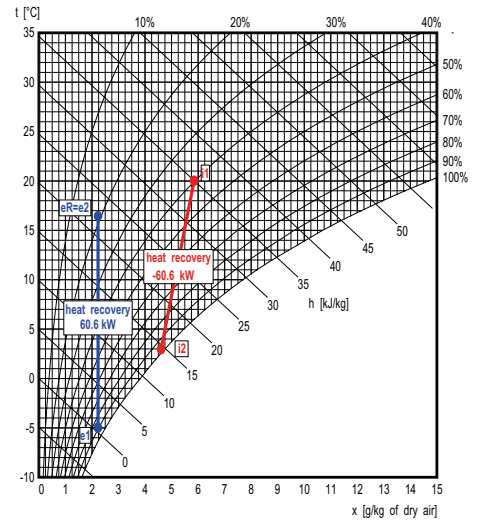
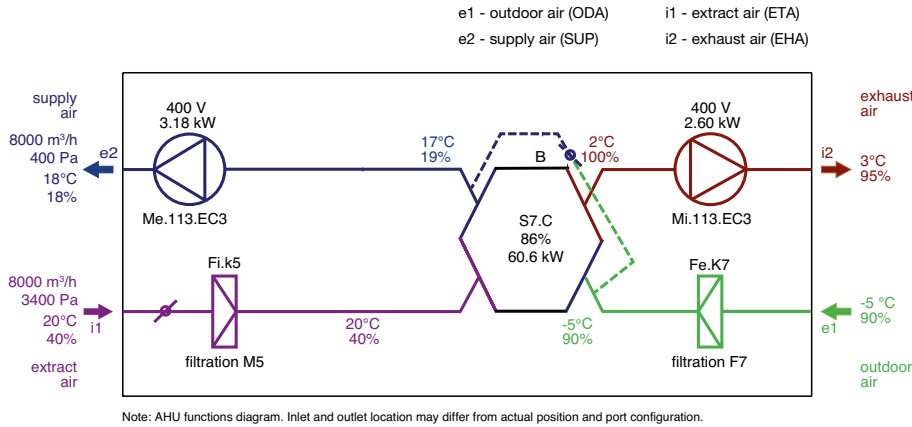

Supply

Description	t [°C]	RH [%]
e1 Outdoor Air	-5.0	90
e2 Supply Air	17.8	18

Exhaust

Description	t [°C]	RH [%]
i1 Extract Air	20.0	40
i2 Exhaust Air	2.7	95

Summer Operation:

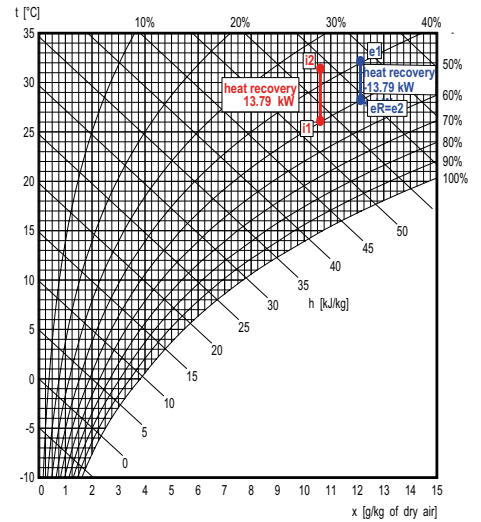
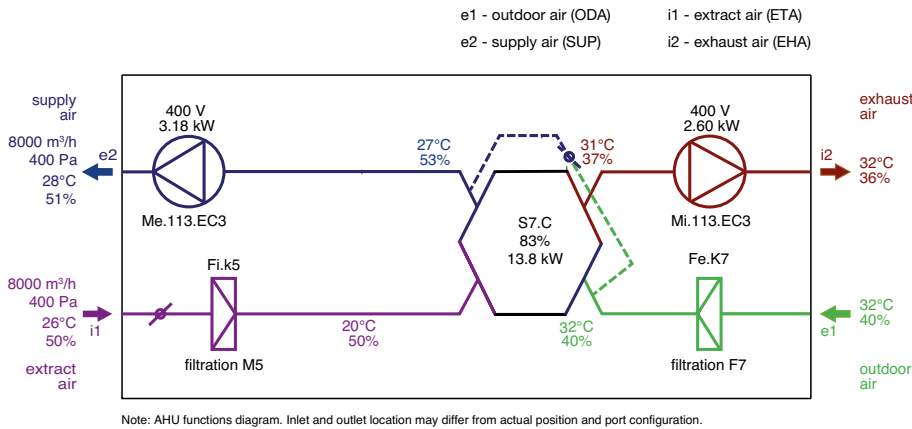

Supply

Description	t [°C]	RH [%]
e1 Outdoor Air	32.0	40
e2 Supply Air	28.0	51

Exhaust

Description	t [°C]	RH [%]
i1 Extract Air	26.0	50
i2 Exhaust Air	31.7	36

FILTERS

Filtration Type	Supply	Extract	Accessories (part of delivery)
	Pleated Cartridge		
Filtration class	ePM2,5 65 % (F7)	ePM10 70 % (M5)	Pfe dirty filter pressure switch for supply air
Number of filters	1+3	1+3	Pfi dirty filter pressure switch for extract air
Filter cartridge size	750x295x96 750x405x96	750x295x96 750x405x96	

Duplexvent Multi eco-Roof DV9000

Commercial MVHR with cross-counter-flow heat exchanger - Outdoor

OPTIONAL ACCESSORIES

ELECTRIC PRE-HEATER

Electric pre-heater		Supply
Air volume	m ³ /h / l/s	8000 / 2222
Maximum heating capacity	kW	54.0
Voltage	V	400
Connection ports	mm	500x800

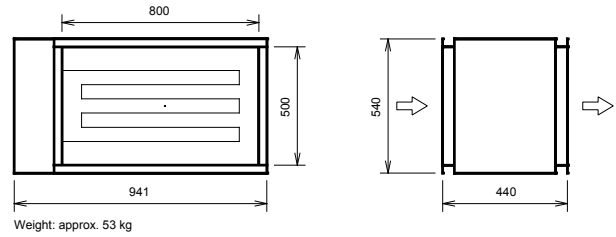

WATER HEATING COIL

Water heating coil		Supply
Heating medium		21% Ethylene glycol
Air volume	m ³ /h / l/s	8000 / 2222
Temperature at inlet (after heat recovery)	°C	17
Temperature at outlet (downstream of the heater)	°C	19
Heating capacity	kW	5.5
Heating medium temperature drop	°C	70/50
Medium flow (from source)	l/h	237
Connection dimension (hydraulic kit)		5/4" female

Note: The figures above have been measured at 8000 m³/h and 400 Pa. Please use the Duplexvent Selection Software to calculate measurements at other performance levels.

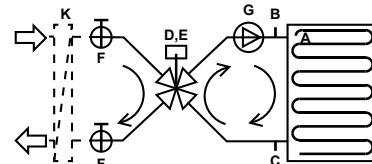

- A Freeze protection thermostat 016-H6929-109-6m (2)
 - B Air vent automatic (2)
 - C Sludge valve plug (2)
 - Hydraulic kit: RE-TPO4. LM24A-SR
 - D Mixing valve IVAR.MIX4, Kv 12, 1" T (2)
 - E Actuator LM24A-SR (2)
 - F Globe valve 1" (2)
 - G Pump WILO YONOS PARA RS 20/6- RKC (2)
 - Others:
 - K Coil water/ethylene glycol (3)
- 1 - Delivered separately
2 - Fitted and connected
3 - Not part of delivery, recommended

HEATING CAPACITY

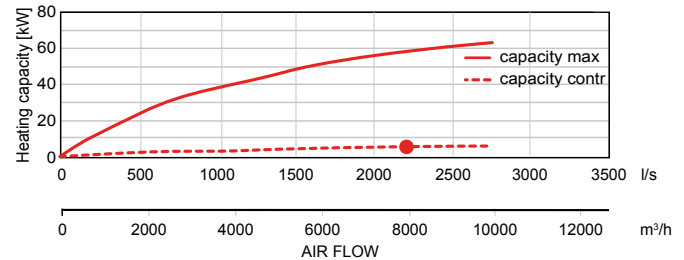

WATER COOLING COIL

Water cooling coil		Supply
Cooling medium		21% Ethylene glycol
Air volume	m ³ /h / l/s	8000 / 2222
Temperature at inlet (after heat recovery)	°C	27
Temperature at outlet (downstream of the cooling coil)	°C	18
Inlet relative humidity (after heat recovery)	% RH	53
Outlet relative humidity (downstream of the cooling coil)	% RH	93
Cooling capacity	kW	24.6
Condensate production	l/h	1
Water temperature drop	°C	6 / 12
Medium flow (at max. capacity)	l/h	3710
Medium-side pressure drop		
in heat exchanger	kPa	4.05
in valve	kPa	13.45
Connection dimension		5/4" female

Note: The figures above have been measured at 8000 m³/h and 400 Pa. Please use the Duplexvent Selection Software to calculate measurements at other performance levels.

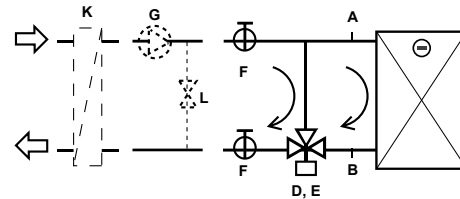

- A Air vent automatic (2)
 - B Sludge valve plug (2)
 - Hydraulic kit: R-CHW3.E.TR 24-SR
 - D 3-way ball valve R3020-B1 (2)
 - E Actuator TR 24-SR (2)
 - F Globe valve 1" (2)
 - Others:
 - G Pump (3)
 - L Water bypass (3)
 - K Coil water/ethylene glycol (3)
- 1 - Delivered separately
2 - Fitted and connected
3 - Not part of delivery

COOLING CAPACITY

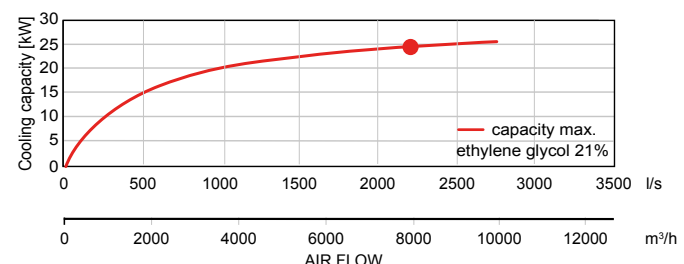

DX COIL

DX coil		Supply
Air volume	m ³ /h / l/s	8000 / 2222
Temperature at inlet (after heat recovery)	°C	27
Temperature at outlet (downstream of the DX coil)	°C	18
Inlet relative humidity (after heat recovery)	% RH	53
Outlet relative humidity (downstream of the DX coil)	% RH	77
Cooling capacity	kW	35.90
Condensate production	l/h	20
Refrigerant type		R410A
Evaporating temperature	°C	5

Note: The figures above have been measured at 8000 m³/h and 400 Pa. Please use the Duplexvent Selection Software to calculate measurements at other performance levels.

COOLING CAPACITY

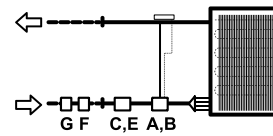
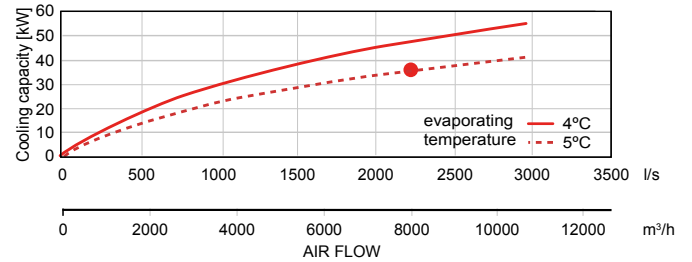

- A Expansion valve 3)
 - B Nozzle 3)
 - C Magnetic valve 3)
 - E Coil ASC 230V/50-60 Hz 3)
 - F Sight glass 3)
 - G Drier 3)
- 3 Not part of delivery, recommended type mentioned**

DIMENSIONS

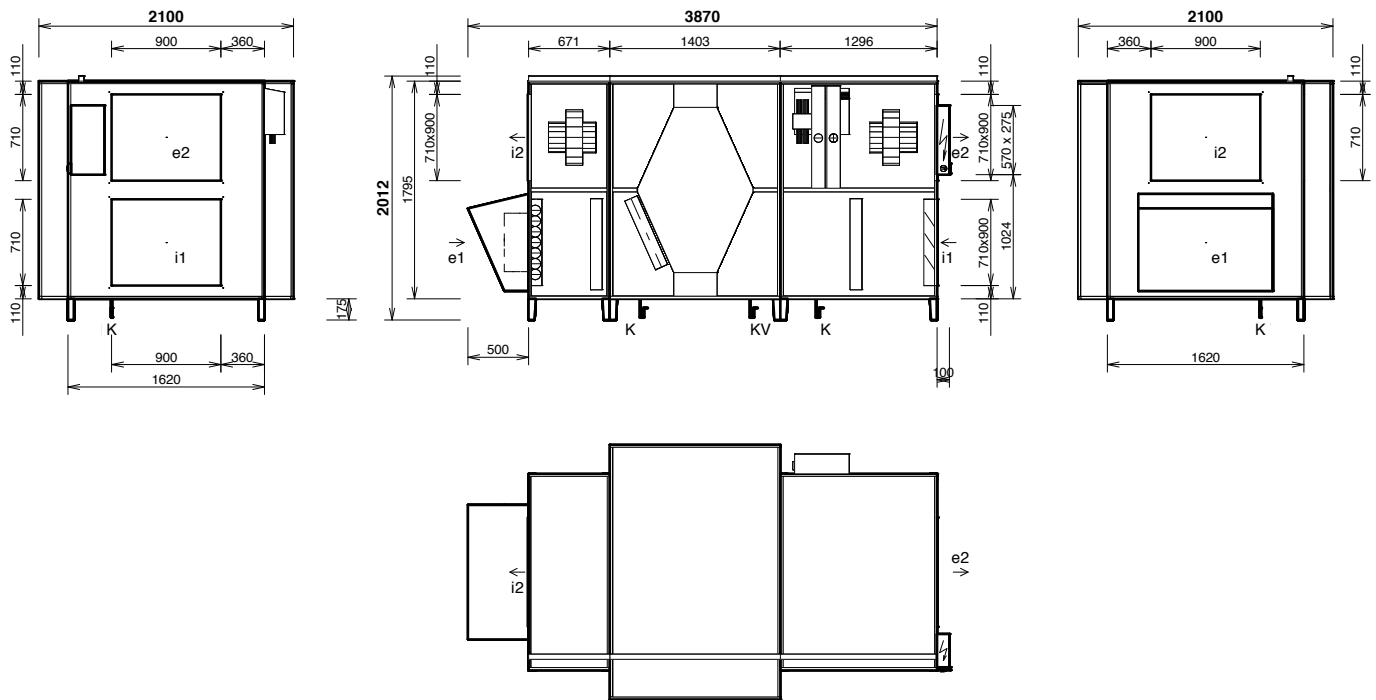

Connections	Type	Dimensions	Optional Components
e1	e1- outdoor air (ODA)		Shutoff damper, Flexible connection
e2	e2- supply air (SUP)	710x900mm	Flexible connection
i1	i1- extract air (ETA)	710x900mm	Shutoff damper, Flexible connection
i2	i2- exhaust air (EHA)	710x900mm	Flexible connection
K	condensate drain	2 x Ø 32 mm/40 mm	Condensate pump

- Notice:
- Unit supplied in three pieces
 - Diagram is intended only for basic information, binding dimensions receive at device delivery, or on request from the manufacturer
 - Bolt holes for duct connection (for one port): 4x M6

Duplexvent Rotary

Heat Recovery Ventilation

ELECTRIC PRE-HEATER

Models available:

DV1500, DV2500, DV4000, DV5000, DV8000,
DV12000 and DV15000

**Rotary Wheel
Heat Exchanger**
Up to 85% thermal
efficiency reduce heating
bills significantly and
guarantee a quick return
on investment

Shut-off Damper
stops the air flow
when required

**Temperature
Sensors**
for fully automatic
operation of the summer
by pass, frost protection
and heater/
cooler facilities

Base Frame
ensures stability
during operation

**High
Grade Filters**
G4 (ISO Coarse 60%) /
M5 (ISO ePM10 70%) /
F7 (ISO ePM2.5 65%)
provide ultra-hygienic
indoor climate and protect
heat exchangers from
getting dirty



**Built-in Heaters/
Coolers**
provide space
saving solution

Up to 20 duct
connection options

Low Energy,
Maintenance Free
EC Fan Technology
ensures long term savings
on operating costs

Digital Control Box
with internet and BMS
connections

Now its easier to
control Duplexvent
units using our new
smartphone app

Pressure Sensors
for filter monitoring

Smooth
Internal Casing
with 30 or 45mm
insulation (class T2)
avoids thermal bridging
(class TB1), absorbs
noise and meets sanitary
standards



Duplexvent Rotary

Commercial MVHR with rotary thermal wheel



KEY FEATURES

- Indoor installation
- Customised units with a choice of duct orientations
- Highly efficient, certified by Eurovent rotary heat exchanger, up to 85% thermal efficiency
- Seven models available
- Excellent thermal insulation (class T2, TB1/TB2)
- Digital touchscreen or simple manual controller
- Integrated web server enables to control the unit via internet
- BMS connection (Modbus as a standard, optional BACnet or KNX)
- VAV control compatibility
- 2 year warranty+

Duplexvent Rotary

The Duplexvent Rotary is a range of all-purpose commercial MVHR units that are suitable for all commercial premises that require ventilation rate from 1400 - 11000 m³/h. The highly efficient rotary wheel heat exchanger recovers up to 85% of otherwise wasted heat to pre-warm the incoming supply air; reducing ongoing energy costs for the building.

Rotary units offer outstanding performance, with low SFP and high end thermal insulation to minimise heat loss. You can control your Rotary unit with ease thanks to a wide range of control options, which enables adjustment of the unit's ventilation with or without a BMS via an internet connected device such as smartphone, computer or Duplexvent digital controller.

+ Excludes motors. Motor warranty one year from date of purchase



CONTROL SYSTEM

BMS control interface is standard with Modbus TCP, (KNX and BACnet optional) protocols.

Alternatively the Duplexvent Web control system with internet connectivity may be specified to control remote equipment from a PC, Tablet or Smart phone





A NEW GENERATION IN MECHANICAL VENTILATION WITH HEAT RECOVERY

Duplexvent Rotary units provide outstanding performance within a compact shape. The system comprises of separate supply and extract backward curved EC fans. Duplexvent Rotary units are easy to transport and install on site and provide excellent MVHR performance for a range of commercial and industrial applications.

The casing is twin skin construction with high insulation and excellent thermal conductivity coefficient of 0.037 W/mK. It is rated to Thermal Insulation class T2 and thermal bridging class

TB1 / TB2 (depending on the unit). Access doors are provided for ease of filter maintenance. Thanks to the highly efficient EC motors, Rotary units achieve extremely low SFP values from 0.45 W (m³/h).

Multiple choice duct connectivity is a feature of the Duplexvent Rotary range. Intake and supply ports can be rotated by 90 degrees to facilitate on-site duct connections in limited access spaces. This enables the connecting ducting to be configured in line with the space available and the structure of the building.



Duplexvent Rotary

Commercial MVHR with rotary thermal wheel

TECHNICAL DATA

OPERATING MODES

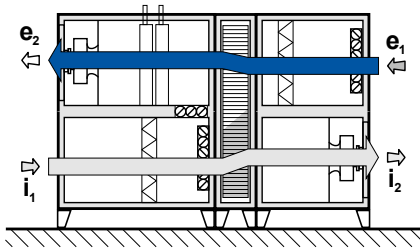

Heat recovery mode with re-heating and cooling

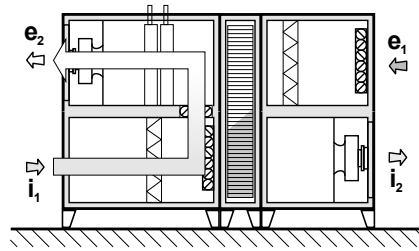

Recirculation mode with heating and cooling

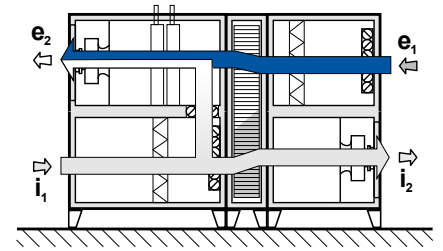

Combined mode (heat recovery mode with recirculation)

➔ e₁ ...Outdoor air (ODA)
 ↻ e₂ ...Supply air (SUP)

➔ i₁ ...Extract air (ETA)
 ↻ i₂ ...Exhaust air (EHA)

T ...Central heating connection
 CH ...Cooling connection

Duplexvent Rotary		DV1500	DV2500	DV4000	DV5000	DV8000	DV12000	DV15000
Maximum air flow according to ErP 2018	m ³ /h / l/s	1400/389	2400/667	4150/1153	4950/1375	7250/2014	9400/2611	11000/3056
Reference external static pressure	Pa	200	200	200	200	400	400	400
Heat recovery efficiency	%	see curve						
Fan type		EC (backward curved impeller)						
Weight ¹	kg	350 - 400	360 - 405	570 - 640	575 - 645	938 - 1060	1210 - 1360	1421 - 1610
Max power consumption	W	800	1700	2900	5100	9900	10200	11300
Voltage	V	230			400			
Frequency	Hz	50						
Fan speed	min ⁻¹	3350	2960	3000	2980	2570	2130	1860
Heating output T - max. ²	kW	17	22	42	50	70	100	120
Cooling output CHW - max. ²	kW	10	18	35	39	50	61	80
Cooling output CHF - max. ²	kW	17	24	36	40	47	60	85
Part Number		90000724	90000725	90000726	90000727	90000568	90000569	90000570

1. Depending on equipment
 2. Depending on flow rate, external air temperature, medium type
- T - Water heating coil
 CHW - Water cooling coil
 CHF - DX (direct expansion) coil

PERFORMANCE

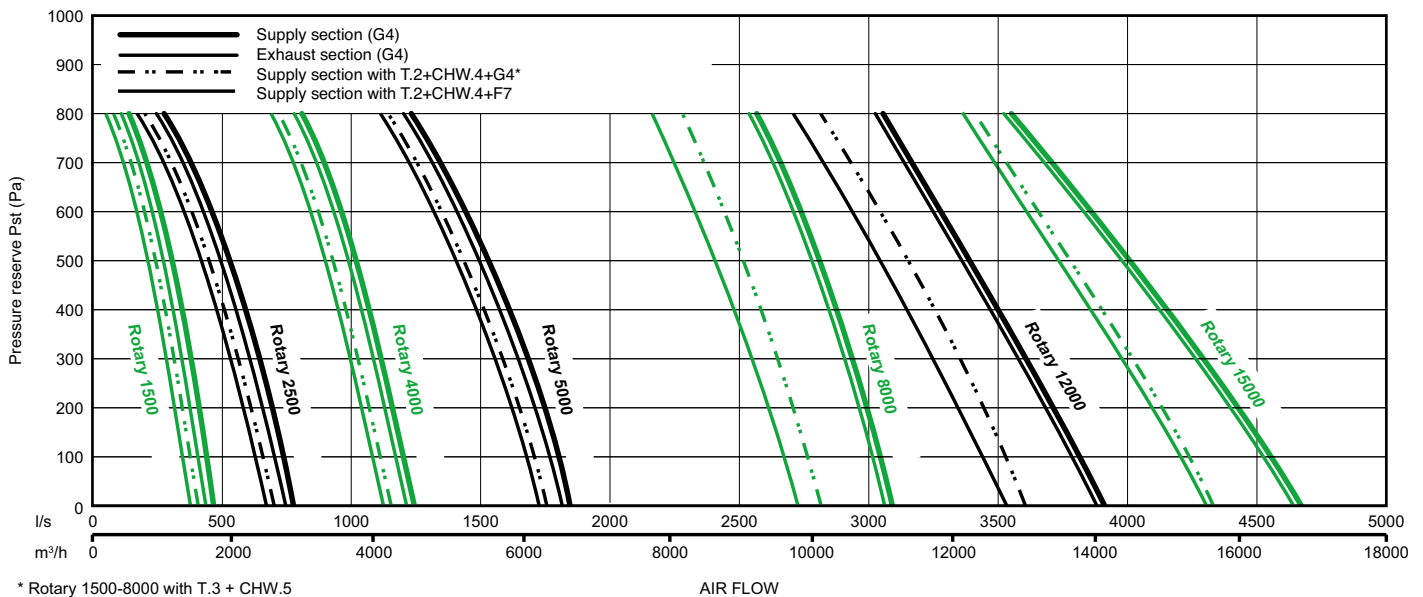

HEATING AND COOLING CAPACITY

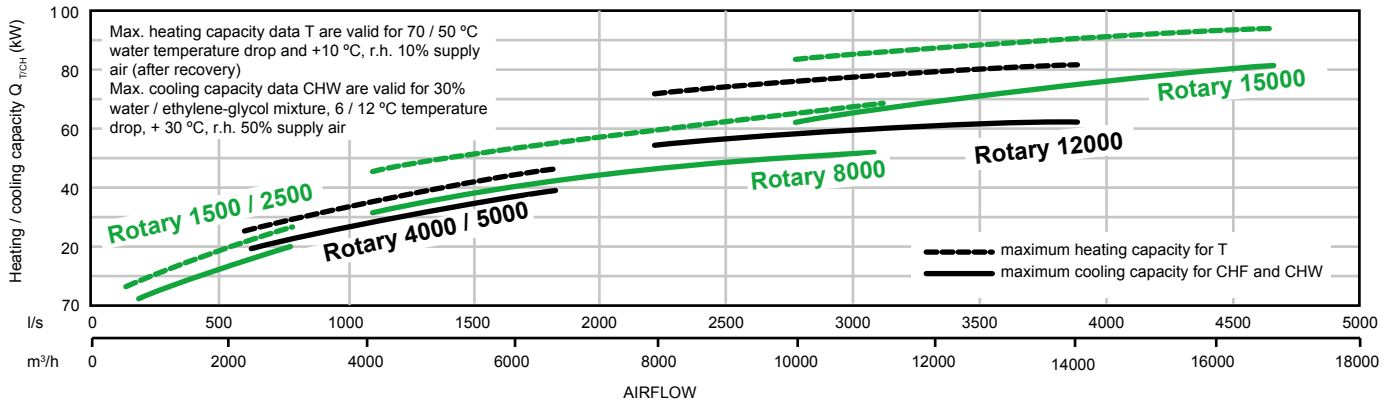

HEAT RECOVERY EFFICIENCY

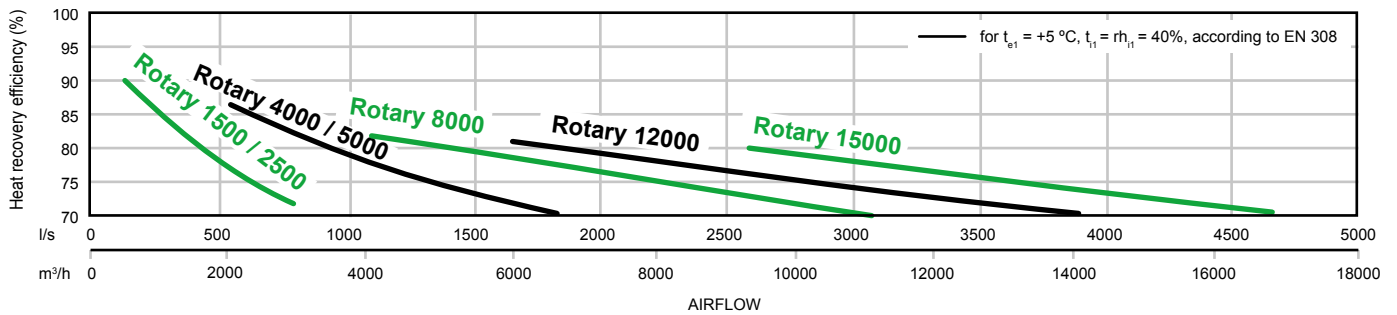

CONNECTION PORTS

RECTANGULAR

Duplexvent Rotary	R
DV1500 - 5000	20 mm
DV8000 - 15000	30 mm

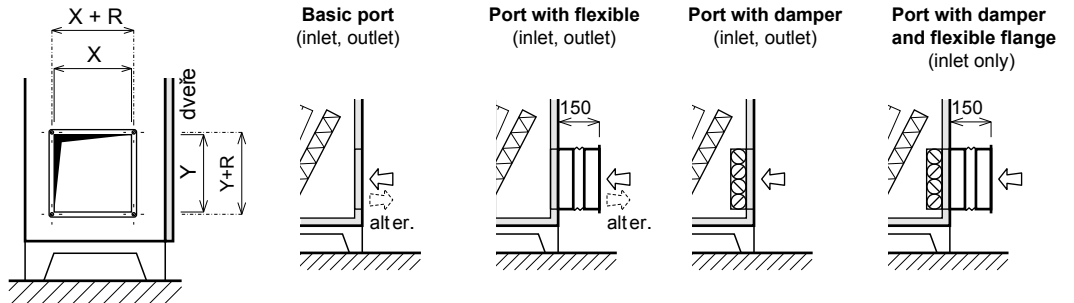

Note: For detailed information we recommend using Duplexvent selection software available at airflow.com

Duplexvent Rotary

Commercial MVHR with rotary thermal wheel

INSTALLATION CONFIGURATION

DUPLEXVENT ROTARY INSTALLATION POSITIONS AND PORT CONFIGURATIONS

The Duplexvent Rotary range is available in a number of different configurations. This connection versatility enables the Duplexvent Rotary units to be installed in cramped spaces.

For a detailed unit design we recommend a Duplexvent selection software to be used; available at www.airflow.com

All Duplexvent Rotary units are available with a wide range of accessories. For example, the ports can be fitted with flexible flanges and shut-off dampers if required.

FLOOR STANDING DV1500 - 15000

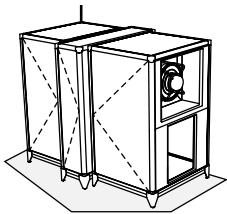

configuration 60/x - door side view [up to 4 configurations in total]

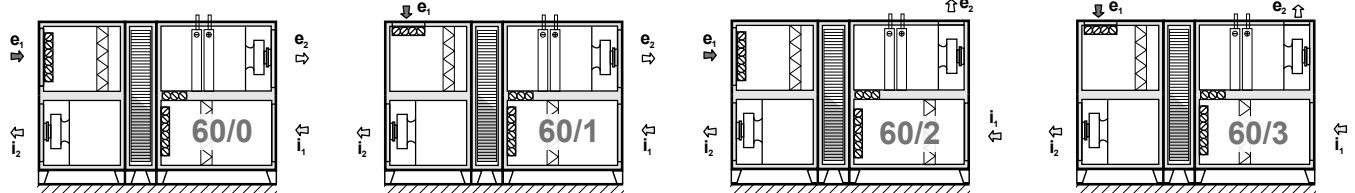

configuration 61/x - door side view [up to 4 configurations in total]

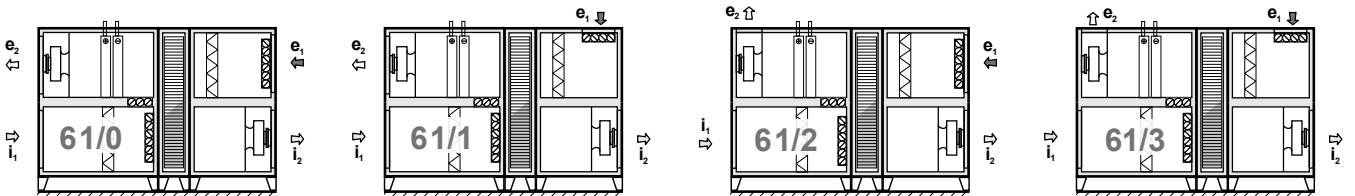

MANIPULATION SPACE

DUPLEXVENT ROTARY MANIPULATION SPACE

Duplexvent Rotary units must be installed with the unit's handling space (outlined below) in mind.

There must be a 150 mm gap underneath the unit to install the condensate drain system, as the system must run through a U-bend at least 150 mm high into the sewer. This space is easily achieved when the supporting feet, which are supplied as standard, are used when the unit is installed. The handling

space in front of the unit must be maintained so the unit can be serviced.

In addition the handling spaces outlined below, there must be a minimum 600 mm space from the side of electric switchboard of the control system.

Units fitted with additional heaters or coolers must have free space from the side of the manifold.

MANIPULATION SPACE, UNIT CONFIGURATION

Floor-standing horizontal

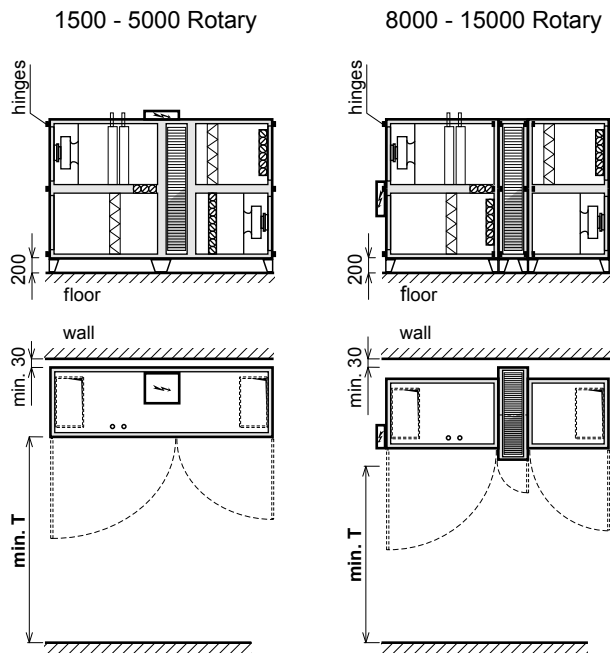

MANIPULATION SPACE FOR UNIT ACCESSORIES

Control modules

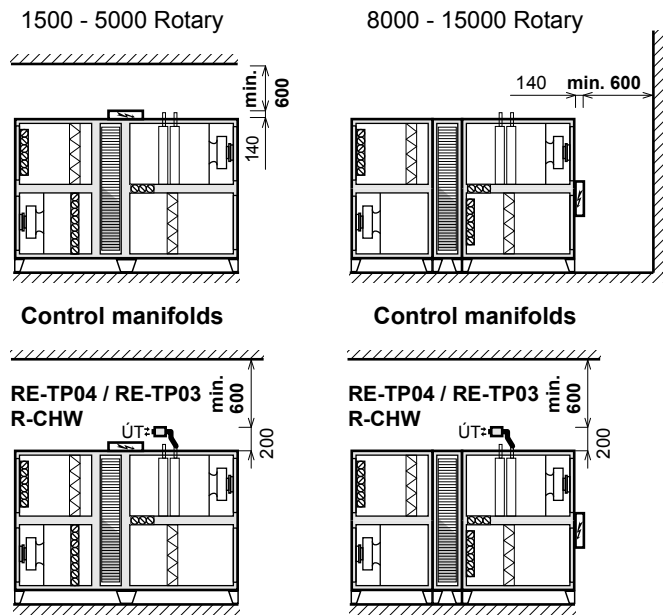

Duplexvent Rotary	Standard door T [mm]
DV1500	900
DV2500	900
DV4000	1200
DV5000	1200
DV8000	1600
DV12000	1800
DV15000	2000

Duplexvent Rotary DV1500

Commercial MVHR with rotary thermal wheel - Indoor



KEY FEATURES

- Air volume up to 1000 m³/h at 200 Pa according to ErP 2018
- Highly efficient, certified by Eurovent rotary heat exchanger, up to 85% thermal efficiency
- Low SFP and energy saving EC fans
- Digital touchscreen or simple manual controller
- BMS connection
- VAV control compatibility
- Filters: ePM2,5 65 % (F7), ePM10 70 % (M5) or Coarse 60 % (G4)
- Optional equipment: recirculation damper, heating or cooling coils, purge chamber
- Optional constant flow / pressure mode
- 2 year warranty+

PERFORMANCE

Ventilation		Supply Air	Extract Air
Air volume @ 200 Pa	m ³ /h / l/s	1000 / 278	1000 / 278
Nominal voltage	V	230	230
Nominal power (at operation point)	kW	0.1	0.1
Fan Speed	min ⁻¹	2709	2614
Max power input	kW	0.4	0.4
Max current	A	2.5	2.5
Fan Type		EC	EC

Note: The figures above have been measured at 1000 m³/h and 200 Pa. Please use the Duplexvent Selection Software to calculate measurements at other performance levels.

AIR FLOW CURVE

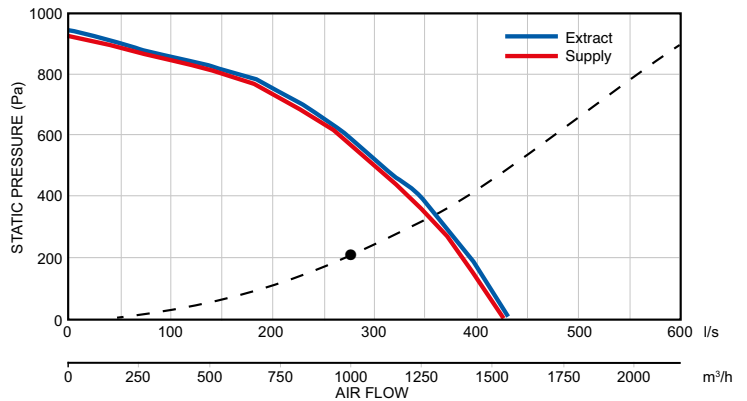

Heat Recovery		Supply Air	Extract Air
Air volume @ 200 Pa	m ³ /h / l/s	1000 / 278	1000 / 278
Temperature at inlet	°C	-5	20
Temperature at outlet	°C	16.8	0.1
Humidity at inlet	% RH	90	40
Humidity at outlet	% RH	33	93
Heat recovery efficiency winter/summer	%	86 / 87	
Humidity recovery efficiency winter/summer	%	46 / 0	
Total heat gain winter/summer	kW	8.6 / 1.8	
Sensible heat gain winter/summer	kW	6.8 / 2.0	
Latent heat gain winter/summer	kW	1.9 / 0	
Heat exchanger speed	RPM	10-13	
Type of heat exchanger		Thermal Rotary Wheel	
Part No.		90000724	

Note: The figures above have been measured at 1000 m³/h and 200 Pa. Please use the Duplexvent Selection Software to calculate measurements at other performance levels.

POWER CONSUMPTION

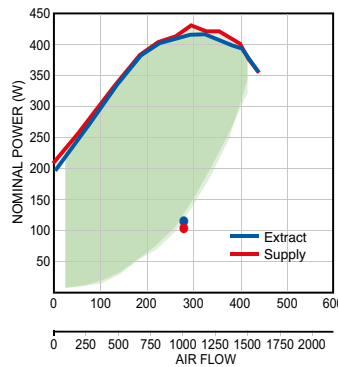

Note: Green area denotes power consumption range. Power consumption depends on system installation.
+ excludes motors. Motor warranty one year from date of purchase.

HEAT RECOVERY EFFICIENCY

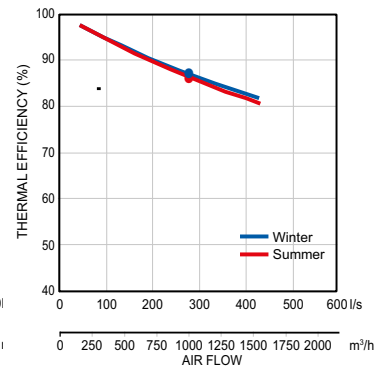

Sound Power Level L _w	Total	dB (A)							
		63 Hz	125 Hz	250 Hz	500 Hz	1 kHz	2 kHz	4 kHz	8 kHz
Outdoor air e1	59	33	39	52	53	54	53	48	44
Supply air e2	77	42	48	55	64	71	74	68	70
Extract air i1	59	32	39	50	52	52	53	50	42
Exhaust air i2	77	40	48	54	63	69	73	69	69
Breakout noise	53	46	37	47	44	47	43	37	29
Sound Pressure Level L _p measured at 3m	32	25	<25	26	<25	27	<25	<25	<25

Note: The figures above have been measured at 1000 m³/h and 200 Pa. Please use the Duplexvent Selection Software to calculate measurements at other performance levels.

Winter Operation:

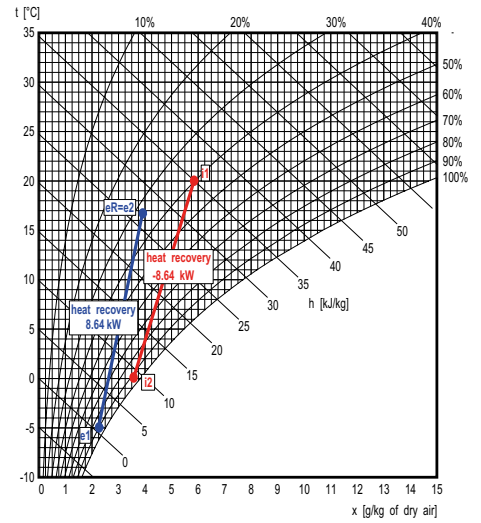
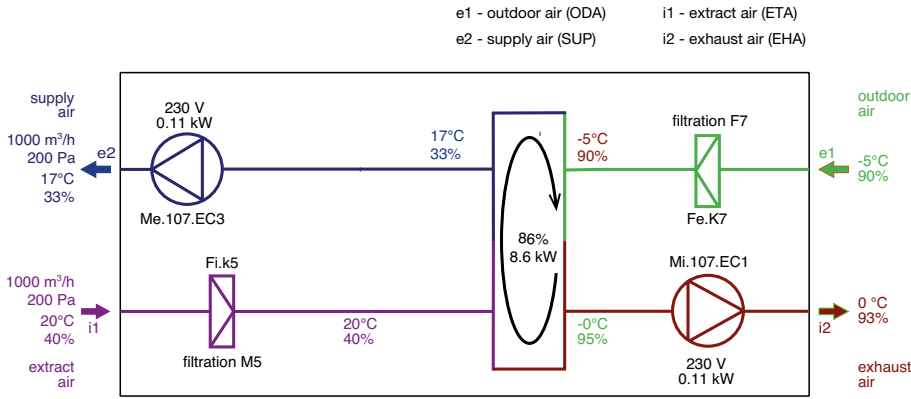

Note: AHU functions diagram. Inlet and outlet location may differ from actual position and port configuration.

Supply

Description	t [°C]	RH [%]
e1 Outdoor air	-5.0	90
e2 Supply air	16.8	33

Exhaust

Description	t [°C]	RH [%]
i1 Extract Air	20.0	40
i2 Exhaust Air	0.1	93

Summer Operation:

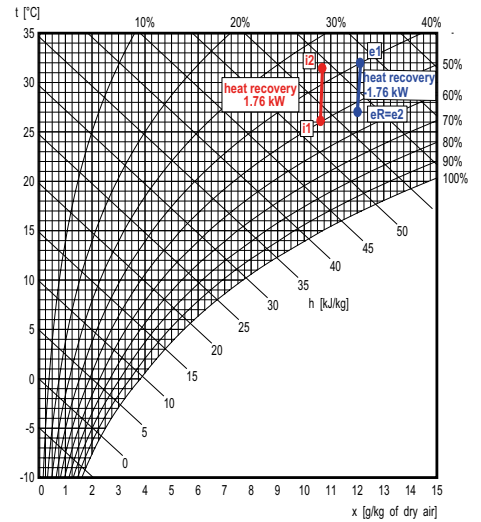
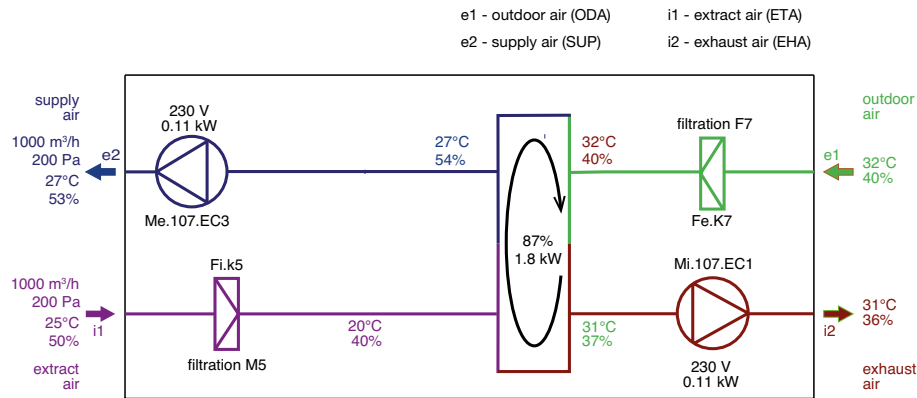

Note: AHU functions diagram. Inlet and outlet location may differ from actual position and port configuration.

Supply

Description	t [°C]	RH [%]
e1 Outdoor Air	32.0	40
e2 Supply Air	27.0	53

Exhaust

Description	t [°C]	RH [%]
i1 Extract Air	26.0	50
i2 Exhaust Air	31.5	36

FILTERS

Filtration	Supply	Extract	Accessories (part of delivery)
Type	Pleated Cartridge		Pfe dirty filter pressure switch for supply air Pfi dirty filter pressure switch for extract air
Filtration class	ePM2,5 65 % (F7)	ePM10 70 % (M5)	
Number of filters	pcs 1	1	
Filter cartridge size	mm 750x495x96	750x495x96	

Duplexvent Rotary DV1500

Commercial MVHR with rotary thermal wheel - Indoor

OPTIONAL ACCESSORIES

ELECTRIC HEATER

Electric pre-heater		Supply
Air volume	m ³ /h / l/s	1000 / 278
Maximum heating capacity	kW	6.0
Voltage	V	400
Connection ports	mm	250x500

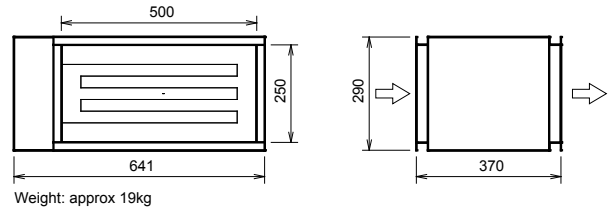

WATER HEATING COIL

Water heating coil		Supply
Heating medium		Water
Air volume	m ³ /h / l/s	1000 / 278
Temperature at inlet (after heat recovery)	°C	15
Temperature at outlet (downstream of the heater)	°C	20
Heating capacity	kW	1.5
Heating medium temperature drop	°C	70 / 50
Medium flow (from source)	l/h	64
Connection dimension (hydraulic kit)		1" female

Note: The figures above have been measured at 1000 m³/h and 200 Pa. Please use the Duplexvent Selection Software to calculate measurements at other performance levels.

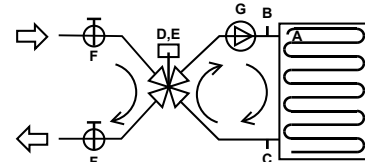

- A Freeze protection thermostat 016-H6927-107-3m
 - B Air vent automatic
 - C Sludge valve plug
 - Hydraulic kit: RE-TPO4. LM24A-SR**
 - D Mixing valve
 - E Actuator
 - F Globe valve 1"
 - G Pump
- IVAR.MIX4, Kv 12, 1" LM24A-SR
WILO YONOS PARA RS 20/6- RKC
- 1) 2)
 - 2) 2)
 - 1) 1)
 - 1) 1)
 - 1) 1)
- 1 - Delivered separately
2 - Fitted and connected

HEATING CAPACITY

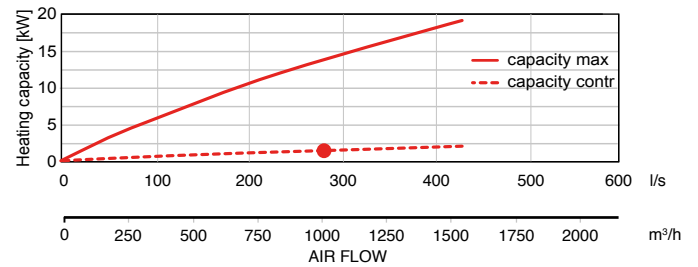

WATER COOLING COIL

Water cooling coil		Supply
Cooling medium		21% Ethylene glycol
Air volume	m ³ /h / l/s	1000 / 278
Temperature at inlet (after heat recovery)	°C	27
Temperature at outlet (downstream of the cooling coil)	°C	17
Inlet relative humidity (after heat recovery)	% RH	54
Outlet relative humidity (downstream of the cooling coil)	% RH	85
Cooling capacity	kW	4.9
Condensate production	l/h	2
Water temperature drop	°C	6 / 12
Medium flow (at max. capacity)	l/h	950
Medium-side pressure drop		
in heat exchanger	kPa	3.95
in valve	kPa	0.89
Connection dimension		1" female

Note: The figures above have been measured at 1000 m³/h and 200 Pa. Please use the Duplexvent Selection Software to calculate measurements at other performance levels.

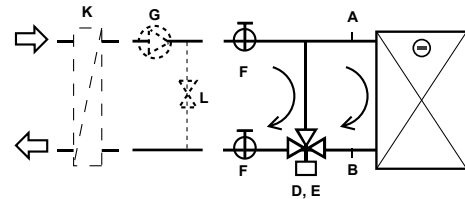

- A Air vent automatic
 - B Sludge valve plug
 - Hydraulic kit: R-CHW3.E.TR 24-SR**
 - D 3-way ball valve
 - E Actuator
 - F Globe valve
 - G Pump
 - L Water bypass
 - K Coil water/ethylene glycol
- R3020-B1 TR 24-SR 1"
- 2) 2)
 - 2) 2)
 - 2) 2)
 - 3) 3)
 - 3) 3)
 - 3) 3)
- 1 - Delivered separately
2 - Fitted and connected
3 - Not part of delivery

COOLING CAPACITY

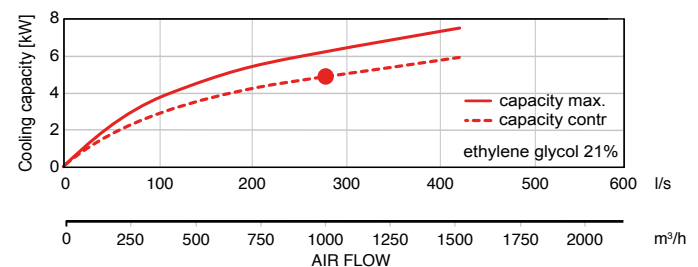

DX COIL

DX coil		Supply
Air volume	m ³ /h / l/s	1000 / 278
Temperature at inlet (after heat recovery)	°C	27
Temperature at outlet (downstream of the DX coil)	°C	17
Inlet relative humidity (after heat recovery)	% RH	54
Outlet relative humidity (downstream of the DX coil)	% RH	77
Cooling capacity	kW	5.30
Condensate production	l/h	4
Refrigerant type		R410A
Evaporating temperature	°C	5

Note: The figures above have been measured at 1000 m³/h and 200 Pa. Please use the Duplexvent Selection Software to calculate measurements at other performance levels.

COOLING CAPACITY

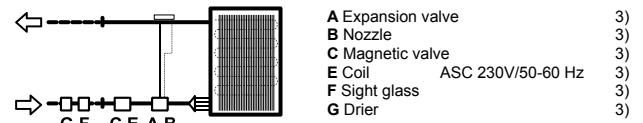
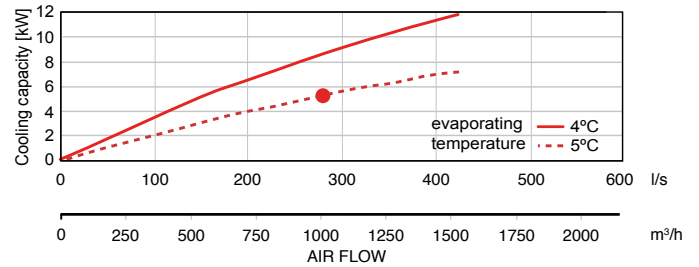

- A Expansion valve (3)
- B Nozzle (3)
- C Magnetic valve (3)
- E Coil ASC 230V/50-60 Hz (3)
- F Sight glass (3)
- G Drier (3)

3 Not part of delivery, recommended type mentioned

DIMENSIONS

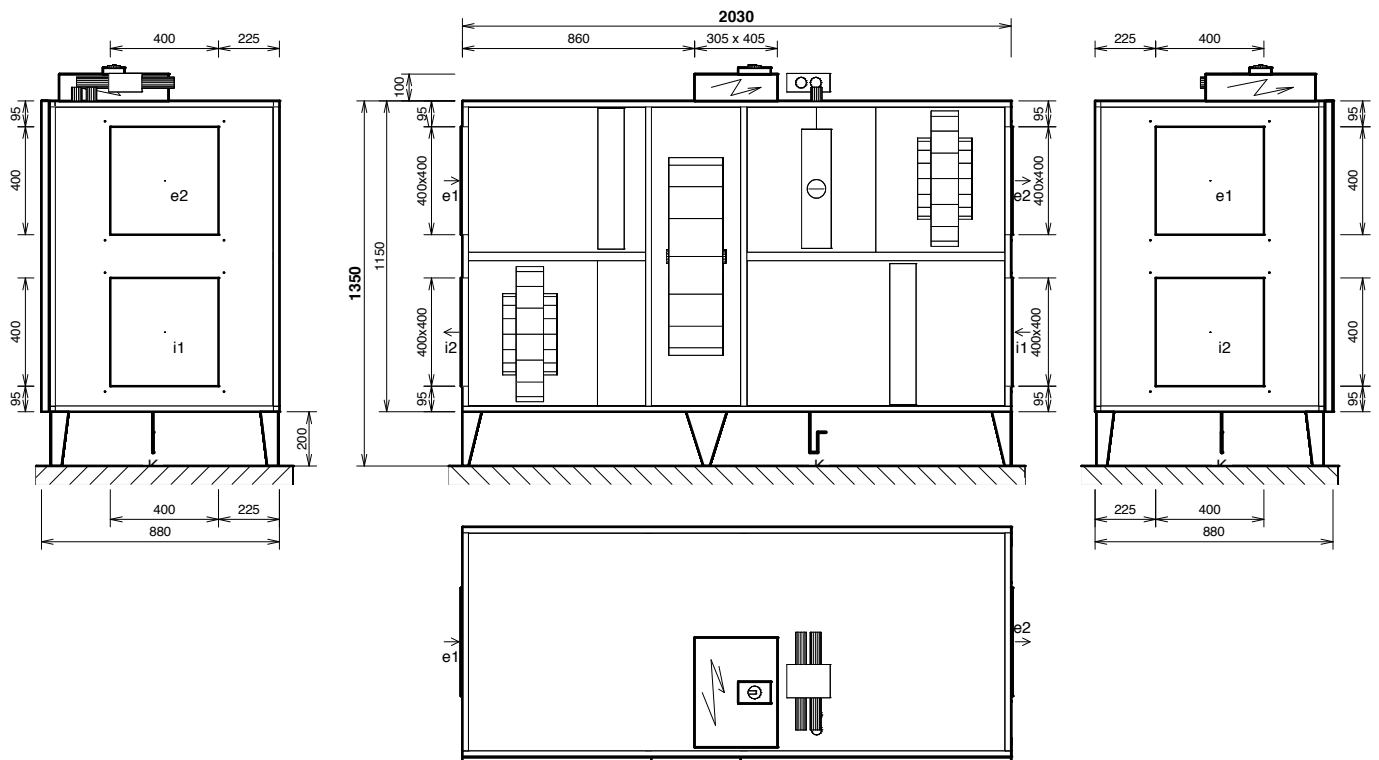

Connections	Type	Dimensions	Optional components
e1	e1- outdoor air (ODA)	400x400mm	Shutoff damper, Flexible connection
e2	e2- supply air (SUP)	400x400mm	Flexible connection
i1	i1- extract air (ETA)	400x400mm	Shutoff damper, Flexible connection
i2	i2- exhaust air (EHA)	400x400mm	Flexible connection
K	condensate drain	Ø 32 mm/40 mm	Condensate pump

Notice:

- Unit delivered as 1 piece
- Door is 3 parts
- Diagram is intended only for basic information, binding dimensions receive at device delivery, or on request from the manufacturer
- Bolt holes for duct connection (for one port): 4x M6

Duplexvent Rotary DV2500

Commercial MVHR with rotary thermal wheel - Indoor



KEY FEATURES

- Air volume up to 2000 m³/h at 200 Pa according to ErP 2018
- Highly efficient, certified by Eurovent rotary heat exchanger, up to 85% thermal efficiency
- Low SFP and energy saving EC fans
- Digital touchscreen or manual controller or BMS
- VAV control compatibility
- Filters: ePM2,5 65 % (F7), ePM10 70 % (M5) or Coarse 60 % (G4)
- Optional equipment: recirculation damper, heating or cooling coils, purge chamber
- Optional constant flow / pressure mode
- 2 year warranty+

PERFORMANCE

Ventilation		Supply Air	Extract Air
Air volume @ 200 Pa	m ³ /h / l/s	2000 / 556	2000 / 556
Nominal voltage	V	230	230
Nominal power (at operation point)	kW	0.4	0.4
Fan Speed	min ⁻¹	2523	2497
Max power input	kW	0.8	0.8
Max current	A	3.9	3.9
Fan Type		EC	EC

Note: The figures above have been measured at 2000 m³/h and 200 Pa. Please use the Duplexvent Selection Software to calculate measurements at other performance levels.

AIR FLOW CURVE

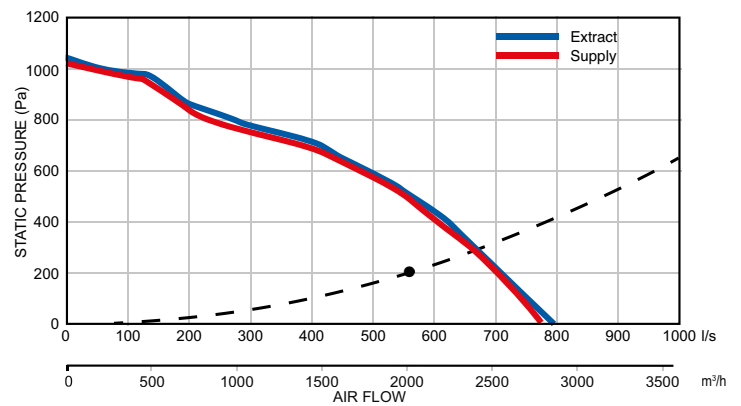

Heat Recovery		Supply Air	Extract Air
Air volume @ 200 Pa	m ³ /h / l/s	2000 / 556	2000 / 556
Temperature at inlet	°C	-5	20
Temperature at outlet	°C	14	2
Humidity at inlet	% RH	90	40
Humidity at outlet	% RH	37	95
Heat recovery efficiency winter/summer	% RH	77 / 78	
Humidity recovery efficiency winter/summer	%	41 / 0	
Total heat gain winter/summer	kW	15.4 / 3.2	
Sensible heat gain winter/summer	kW	12.5 / 3.0	
Latent heat gain winter/summer	kW	3.0 / 0	
Heat exchanger speed	RPM	10-13	
Type of heat exchanger		Thermal Rotary Wheel	
Part No.		90000725	

Note: The figures above have been measured at 2000 m³/h and 200 Pa. Please use the Duplexvent Selection Software to calculate measurements at other performance levels.

POWER CONSUMPTION

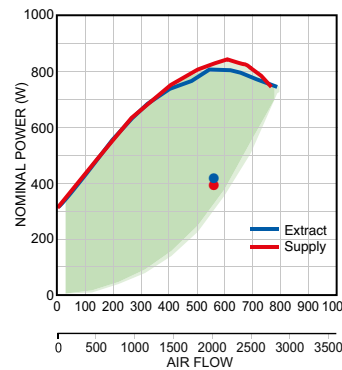

Note: Green area denotes power consumption range. Power consumption depends on system installation.
+ excludes motors. Motor warranty one year from date of purchase.

HEAT RECOVERY EFFICIENCY

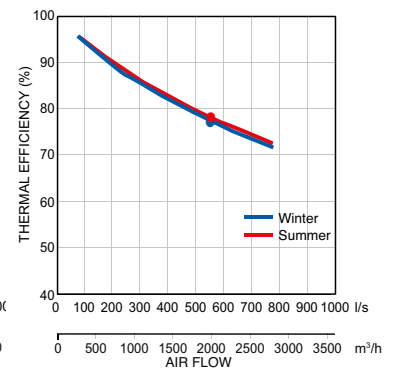

Sound Power Level L _w	Total	dB (A)							
		63 Hz	125 Hz	250 Hz	500 Hz	1 kHz	2 kHz	4 kHz	8 kHz
Outdoor air e1	67	38	46	64	64	56	51	46	40
Supply air e2	80	52	66	75	75	73	70	65	58
Extract air i1	67	38	45	64	63	55	51	45	39
Exhaust air i2	80	51	66	74	75	73	70	64	58
Breakout noise	59	47	40	57	51	49	37	32	<25
Sound Pressure Level L _p measured at 3m	38	27	<25	36	31	28	<25	<25	<25

Note: The figures above have been measured at 2000 m³/h and 200 Pa. Please use the Duplexvent Selection Software to calculate measurements at other performance levels.

Winter Operation:

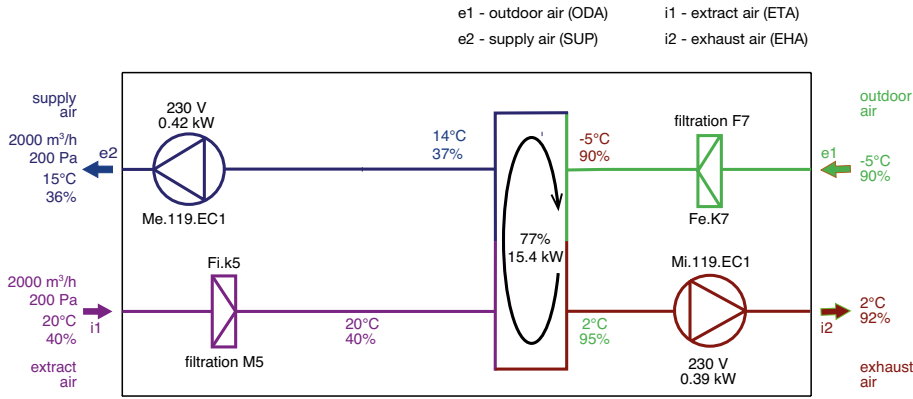

Note: AHU functions diagram. Inlet and outlet location may differ from actual position and port configuration.

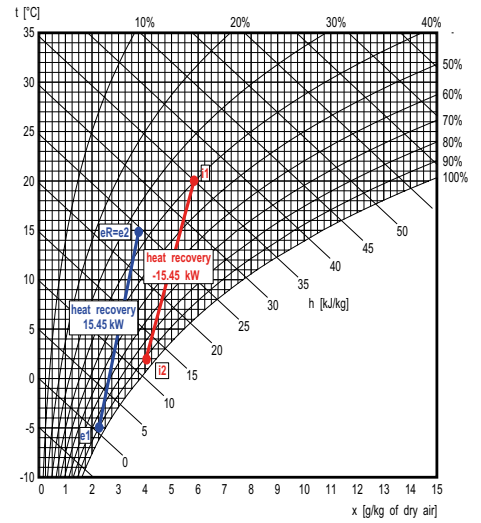

Supply

Description	t [°C]	RH [%]
e1 Outdoor air	-5.0	90
e2 Supply air	14.8	36

Exhaust

Description	t [°C]	RH [%]
i1 Extract Air	20.0	40
i2 Exhaust Air	1.9	92

Summer Operation:

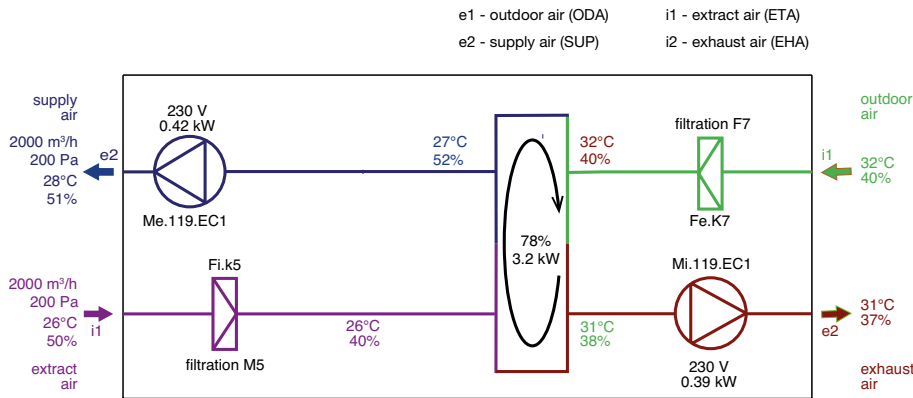

Note: AHU functions diagram. Inlet and outlet location may differ from actual position and port configuration.

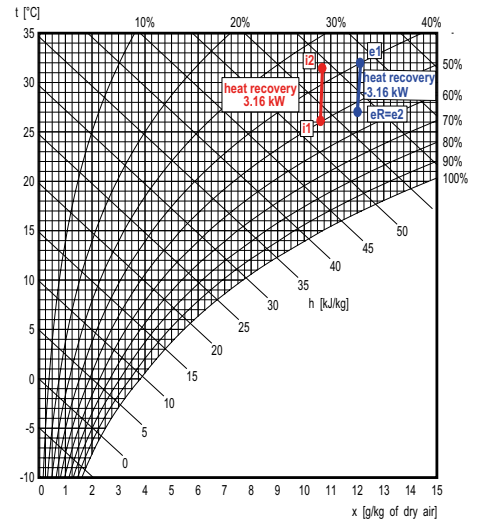

Supply

Description	t [°C]	RH [%]
e1 Outdoor Air	32.0	40
e2 Supply Air	27.8	51

Exhaust

Description	t [°C]	RH [%]
i1 Extract Air	26.0	50
i2 Exhaust Air	31.1	37

FILTERS

Filtration Type	Supply	Extract	Accessories (part of delivery)
	Pleated Cartridge		
Filtration class	ePM2,5 65 % (F7)	ePM10 70 % (M5)	Pfe dirty filter pressure switch for supply air
Number of filters	1	1	Pfi dirty filter pressure switch for extract air
Filter cartridge size	750x495x96	750x495x96	

Duplexvent Rotary DV2500

Commercial MVHR with rotary thermal wheel - Indoor

OPTIONAL ACCESSORIES

ELECTRIC HEATER

Electric pre-heater		Supply
Air volume	m ³ /h / l/s	2000 / 556
Maximum heating capacity	kW	6.0
Voltage	V	400
Connection ports	mm	250x500

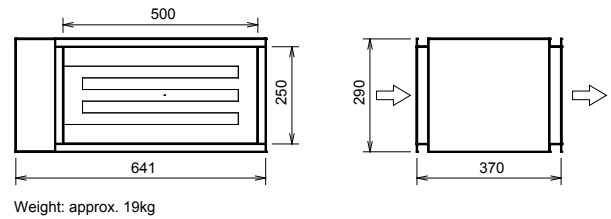

WATER HEATING COIL

Water heating coil		Supply
Heating medium		Water
Air volume	m ³ /h / l/s	2000 / 556
Temperature at inlet (after heat recovery)	°C	14
Temperature at outlet (downstream of the heater)	°C	19
Heating capacity	kW	3.6
Heating medium temperature drop	°C	70 / 50
Medium flow (from source)	l/h	155
Connection dimension (hydraulic kit)		1" female

Note: The figures above have been measured at 2000 m³/h and 200 Pa. Please use the Duplexvent Selection Software to calculate measurements at other performance levels.

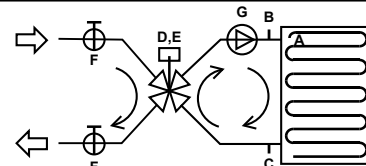

- A Freeze protection thermostat 016-H6927-107-3m
 - B Air vent automatic
 - C Sludge valve plug
 - Hydraulic kit: RE-TPO4. LM24A-SR
 - D Mixing valve
 - E Actuator
 - F Globe valve 1"
 - G Pump
- IVAR.MIX4, Kv 12, 1"
LM24A-SR
WILO YONOS PARA RS 20/6- RKC

- 1 - Delivered separately
- 2 - Fitted and connected

HEATING CAPACITY

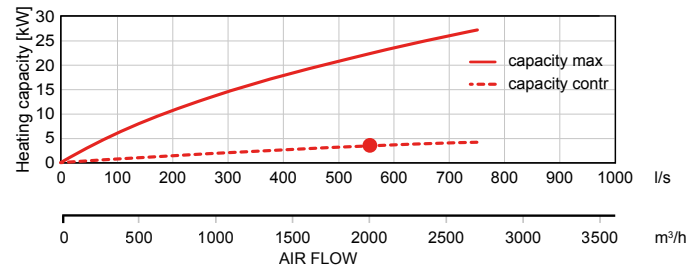

WATER COOLING COIL

Water cooling coil		Supply
Cooling medium		21% Ethylene glycol
Air volume	m ³ /h / l/s	2000 / 556
Temperature at inlet (after heat recovery)	°C	27
Temperature at outlet (downstream of the cooling coil)	°C	16
Inlet relative humidity (after heat recovery)	% RH	52
Outlet relative humidity (downstream of the cooling coil)	% RH	94
Cooling capacity	kW	8.9
Condensate production	l/h	2
Water temperature drop	°C	6 / 12
Medium flow (at max. capacity)	l/h	1350
Medium-side pressure drop		
in heat exchanger	kPa	5.23
in valve	kPa	1.8
Connection dimension		1" female

Note: The figures above have been measured at 2000 m³/h and 200 Pa. Please use the Duplexvent Selection Software to calculate measurements at other performance levels.

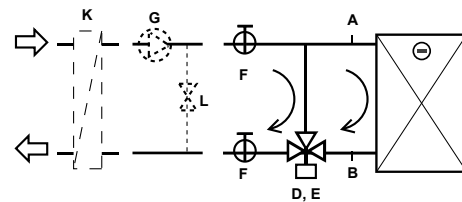

- A Air vent automatic
 - B Sludge valve plug
 - Hydraulic kit: R-CHW3.E.TR 24-SR
 - D 3-way ball valve
 - E Actuator
 - F Globe valve
 - Others:
 - G Pump
 - L Water bypass
 - K Coil water/ethylene glycol
- R3020-B1
TR 24-SR
1"

- 1 - Delivered separately
- 2 - Fitted and connected
- 3 - Not part of delivery

COOLING CAPACITY

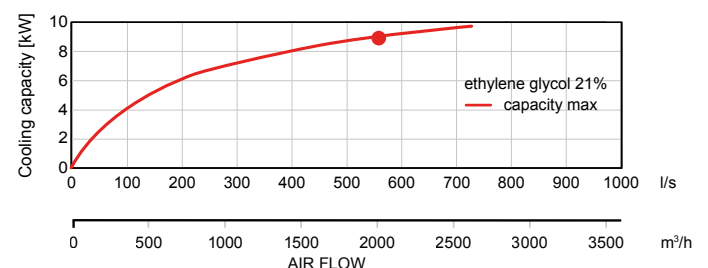

DX COIL

DX coil		Supply
Air volume	m ³ /h / l/s	2000 / 556
Temperature at inlet (after heat recovery)	°C	27
Temperature at outlet (downstream of the DX coil)	°C	16
Inlet relative humidity (after heat recovery)	% RH	52
Outlet relative humidity (downstream of the DX coil)	% RH	77
Cooling capacity	kW	9.33
Condensate production	l/h	7
Refrigerant type		R410A
Evaporating temperature	°C	10

Note: The figures above have been measured at 2000 m³/h and 200 Pa. Please use the Duplexvent Selection Software to calculate measurements at other performance levels.

COOLING CAPACITY

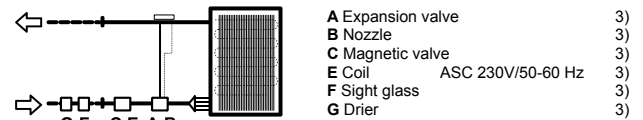
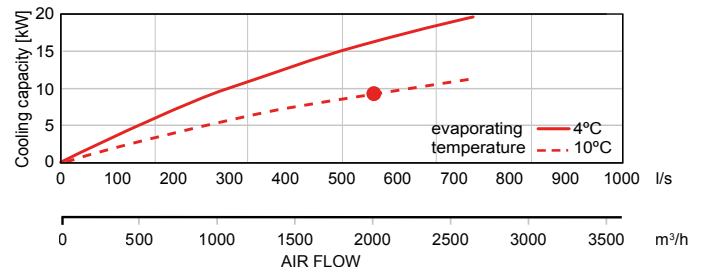

3 Not part of delivery, recommended type mentioned

DIMENSIONS

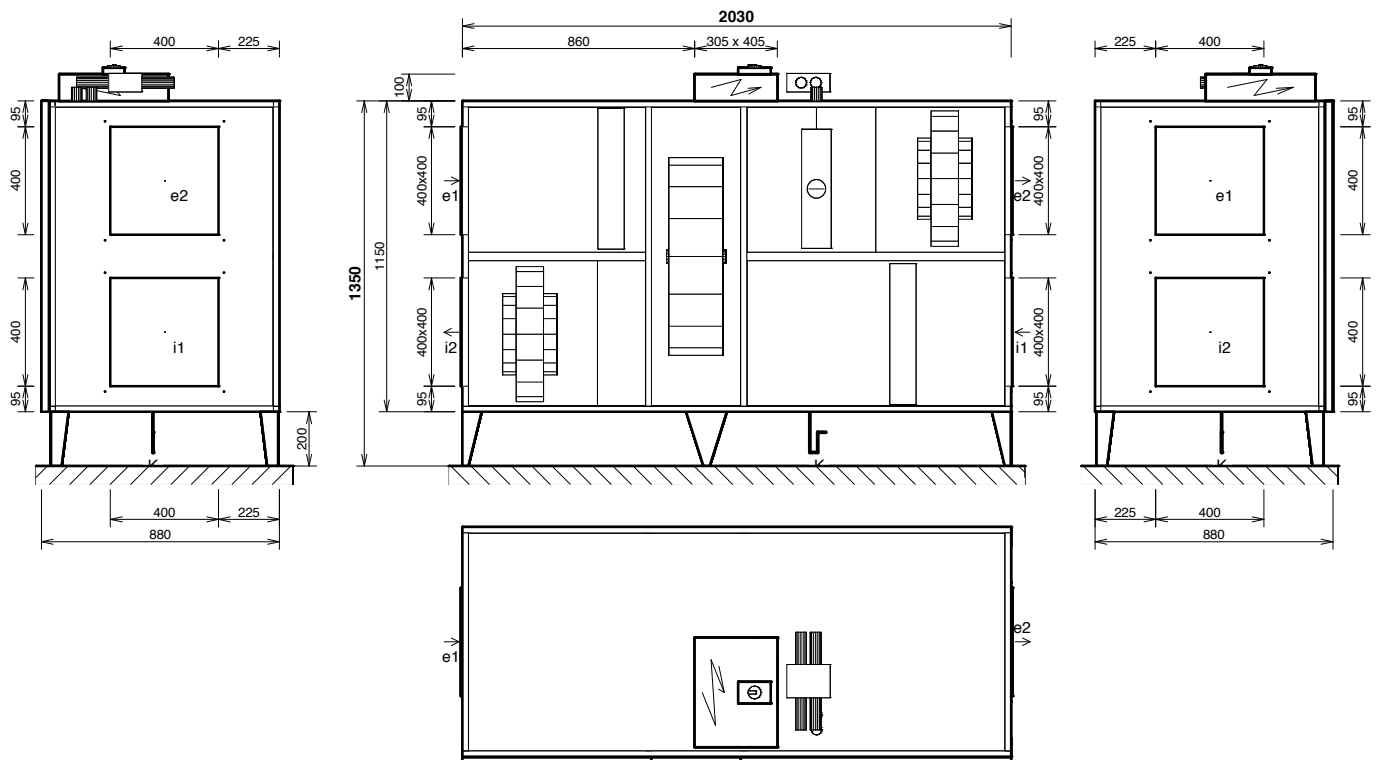

Connections	Type	Dimensions	Optional accessories
e1	e1- outdoor air (ODA)	400x400mm	Shutoff damper, Flexible connection
e2	e2- supply air (SUP)	400x400mm	Flexible connection
i1	i1- extract air (ETA)	400x400mm	Shutoff damper, Flexible connection
i2	i2- exhaust air (EHA)	400x400mm	Flexible connection
K	condensate drain	Ø 32 mm/40 mm	Condensate pump

Notice:

- Unit delivered as 1 piece
- Door is 3 parts
- Diagram is intended only for basic information, binding dimensions receive at device delivery, or on request from the manufacturer
- Bolt holes for duct connection (for one port): 4x M6

Duplexvent Rotary DV4000

Commercial MVHR with rotary thermal wheel - Indoor



KEY FEATURES

- Air volume up to 3500 m³/h at 200 Pa according to ErP 2018
- Highly efficient, certified by Eurovent rotary heat exchanger, up to 85% thermal efficiency
- Low SFP and energy saving EC fans
- Digital touchscreen or manual controller or BMS
- VAV control compatibility
- Filters: ePM2,5 65 % (F7), ePM10 70 % (M5) or Coarse 60 % (G4)
- Optional equipment: recirculation damper, heating or cooling coils, purge chamber
- Optional constant flow / pressure mode
- 2 year warranty+

PERFORMANCE

Ventilation		Supply Air	Extract Air
Air volume @ 200 Pa	m ³ /h / l/s	3500 / 972	3500 / 972
Nominal voltage	V	400	400
Nominal power (at operation point)	kW	0.8	0.7
Fan Speed	min ⁻¹	2564	2506
Max power input	kW	2.5	2.5
Max current	A	4	4
Fan Type		EC	EC

Note: The figures above have been measured at 3500 m³/h and 200 Pa. Please use the Duplexvent Selection Software to calculate measurements at other performance levels.

AIR FLOW CURVE

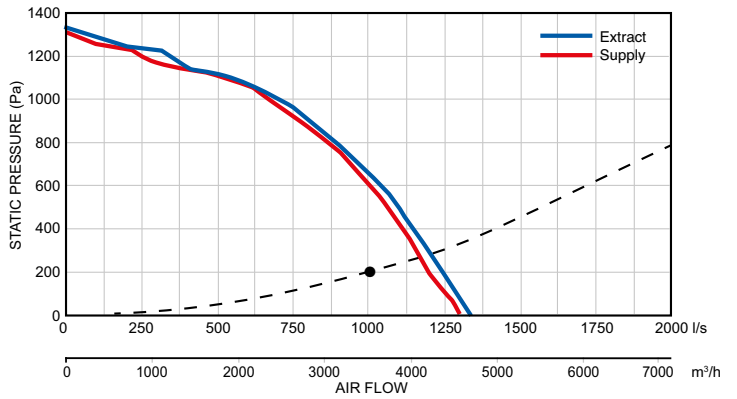

Heat Recovery		Supply Air	Extract Air
Air volume @ 200 Pa	m ³ /h / l/s	3500 / 972	3500 / 972
Temperature at inlet	°C	-5	20
Temperature at outlet	°C	15	1
Humidity at inlet	% RH	90	40
Humidity at outlet	% RH	36	95
Heat recovery efficiency winter/summer	%	79 / 80	
Humidity recovery efficiency winter/summer	%	42 / 0	
Total heat gain winter/summer	kW	27.6 / 5.7	
Sensible heat gain winter/summer	kW	22.2 / 6.0	
Latent heat gain winter/summer	kW	5.5 / 0	
Heat exchanger speed	RPM	10-13	
Type of heat exchanger		Thermal Rotary Wheel	
Part No.		90000726	

Note: The figures above have been measured at 3500 m³/h and 200 Pa. Please use the Duplexvent Selection Software to calculate measurements at other performance levels.

POWER CONSUMPTION

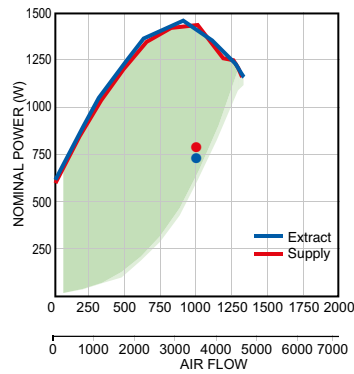

Note: Green area denotes power consumption range. Power consumption depends on system installation.
+ excludes motors. Motor warranty one year from date of purchase.

HEAT RECOVERY EFFICIENCY

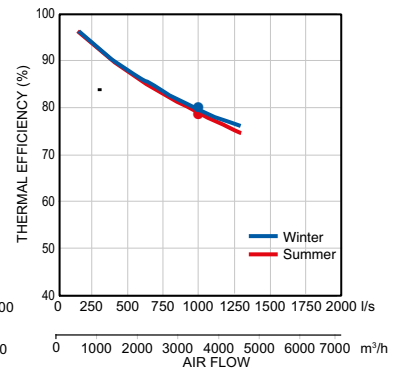

Sound Power Level L _w	Total	dB (A)							
		63 Hz	125 Hz	250 Hz	500 Hz	1 kHz	2 kHz	4 kHz	8 kHz
Outdoor air e1	68	35	47	63	65	60	58	53	50
Supply air e2	87	53	65	79	84	81	76	70	63
Extract air i1	69	36	47	63	65	60	59	53	51
Exhaust air i2	87	53	65	79	84	81	76	71	63
Breakout noise	68	57	47	54	67	59	48	50	32
Sound Pressure Level L_p measured at 3m	48	37	27	33	46	38	28	29	<25

Note: The figures above have been measured at 3500 m³/h and 200 Pa. Please use the Duplexvent Selection Software to calculate measurements at other performance levels.

Winter Operation:

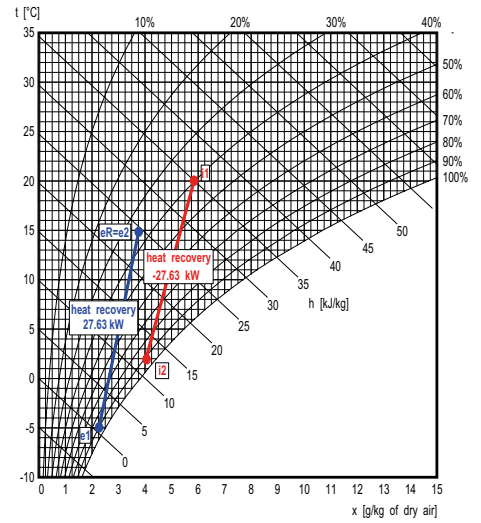
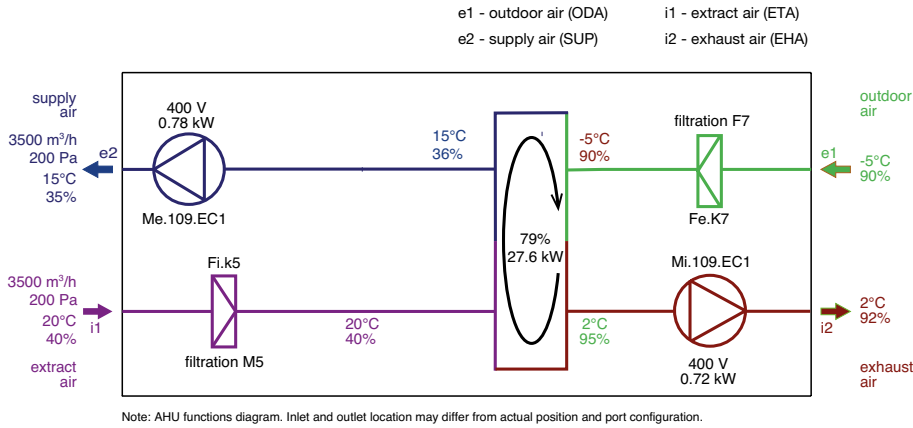

Supply

	Description	t [°C]	RH [%]
e1	Outdoor air	-5.0	90
e2	Supply air	15.2	35

Exhaust

	Description	t [°C]	RH [%]
i1	Extract Air	20.0	40
i2	Exhaust Air	1.6	92

Summer Operation:

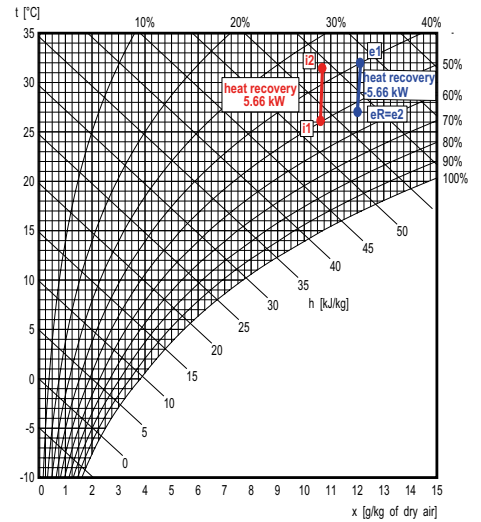
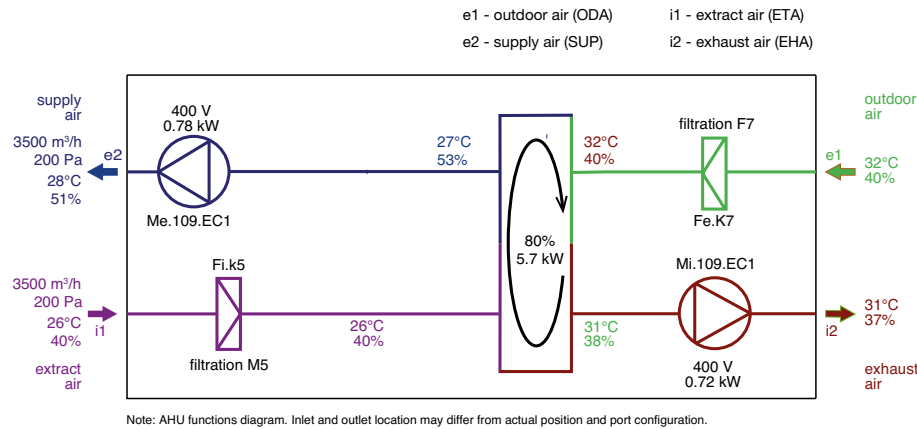

Supply

	Description	t [°C]	RH [%]
e1	Outdoor Air	32.0	40
e2	Supply Air	27.7	51

Exhaust

	Description	t [°C]	RH [%]
i1	Extract Air	26.0	50
i2	Exhaust Air	31.2	37

FILTERS

Filtration	Supply	Extract	Accessories (part of delivery)
Type	Pleated Cartridge		Pfe dirty filter pressure switch for supply air Pfi dirty filter pressure switch for extract air
Filtration class	ePM2,5 65 % (F7)	ePM10 70 % (M5)	
Number of filters	2	2	
Filter cartridge size	750x495x96	750x495x96	

Duplexvent Rotary DV4000

Commercial MVHR with rotary thermal wheel - Indoor

OPTIONAL ACCESSORIES

ELECTRIC HEATER

Electric pre-heater		Supply
Air volume	m ³ /h / l/s	3500 / 972
Maximum heating capacity	kW	9.0
Voltage	V	400
Connection ports	mm	300x600

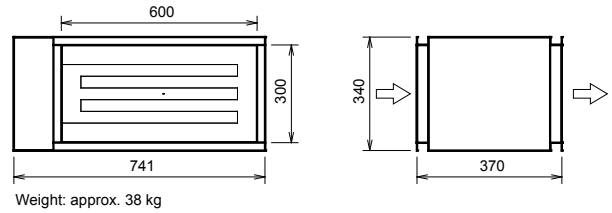

WATER HEATING COIL

Water heating coil		Supply
Heating medium		Water
Air volume	m ³ /h / l/s	3500 / 972
Temperature at inlet (after heat recovery)	°C	15
Temperature at outlet (downstream of the heater)	°C	20
Heating capacity	kW	6
Heating medium temperature drop	°C	70 / 50
Medium flow (from source)	l/h	260
Connection dimension (hydraulic kit)		1" female

Note: The figures above have been measured at 3500 m³/h and 200 Pa. Please use the Duplexvent Selection Software to calculate measurements at other performance levels.

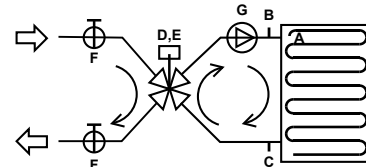

- A Freeze protection thermostat 016-H6929-109-6m
- B Air vent automatic
- C Sludge valve plug
- Hydraulic kit: RE-TPO4. LM24A-SR**
- D Mixing valve IVAR.MIX4, Kv 12, 1"
- E Actuator LM24A-SR
- F Globe valve 1"
- G Pump WILO YONOS PARA RS 20/6- RKC

- 1 - Delivered separately
- 2 - Fitted and connected

HEATING CAPACITY

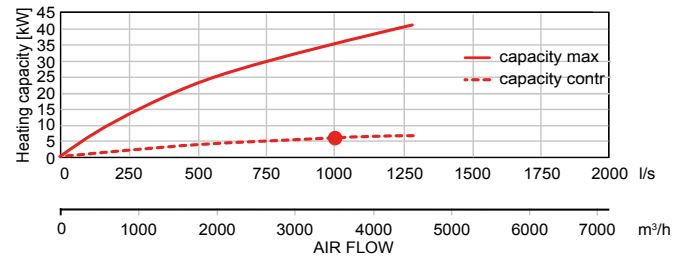

WATER COOLING COIL

Water cooling coil		Supply
Cooling medium		21% Ethylene glycol
Air volume	m ³ /h / l/s	3500 / 972
Temperature at inlet (after heat recovery)	°C	27
Temperature at outlet (downstream of the cooling coil)	°C	16
Inlet relative humidity (after heat recovery)	% RH	53
Outlet relative humidity (downstream of the cooling coil)	% RH	85
Cooling capacity	kW	18.5
Condensate production	l/h	9
Water temperature drop	°C	6 / 12
Medium flow (at max. capacity)	l/h	3270
Medium-side pressure drop		
in heat exchanger	kPa	21.33
in valve	kPa	10.47
Connection dimension		1" female

Note: The figures above have been measured at 3500 m³/h and 200 Pa. Please use the Duplexvent Selection Software to calculate measurements at other performance levels.

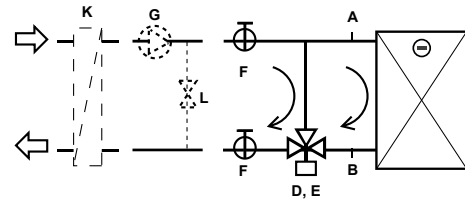

- A Air vent automatic
- B Sludge valve plug
- Hydraulic kit: R-CHW3.E.TR 24-SR**
- D 3-way ball valve R3020-B1
- E Actuator TR 24-SR
- F Globe valve 1"
- Others:**
- G Pump
- L Water bypass
- K Coil water/ethylene glycol

- 1 - Delivered separately
- 2 - Fitted and connected
- 3 - Not part of delivery

COOLING CAPACITY

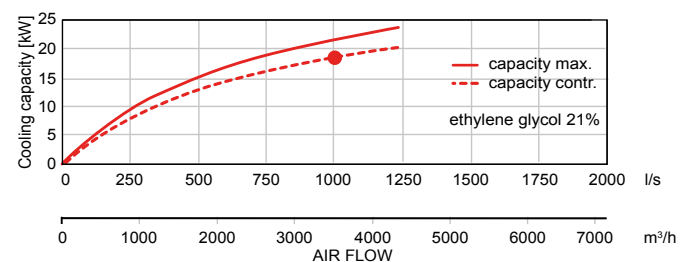

DX COIL

DX coil		Supply
Air volume	m ³ /h / l/s	3500 / 972
Temperature at inlet (after heat recovery)	°C	27
Temperature at outlet (downstream of the DX coil)	°C	17
Inlet relative humidity (after heat recovery)	% RH	53
Outlet relative humidity (downstream of the DX coil)	% RH	79
Cooling capacity	kW	15.28
Condensate production	l/h	12
Refrigerant type		R410A
Evaporating temperature	°C	11

Note: The figures above have been measured at 3500 m³/h and 200 Pa. Please use the Duplexvent Selection Software to calculate measurements at other performance levels.

COOLING CAPACITY

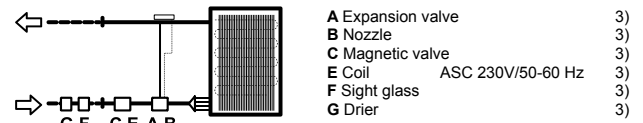
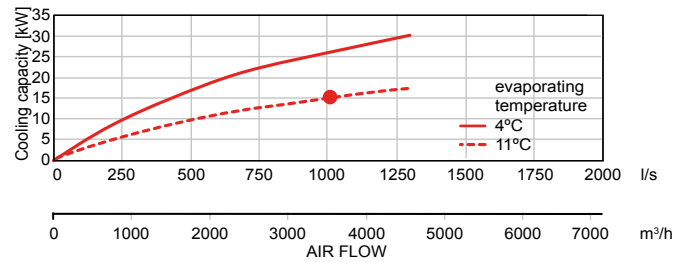

3 Not part of delivery, recommended type mentioned

DIMENSIONS

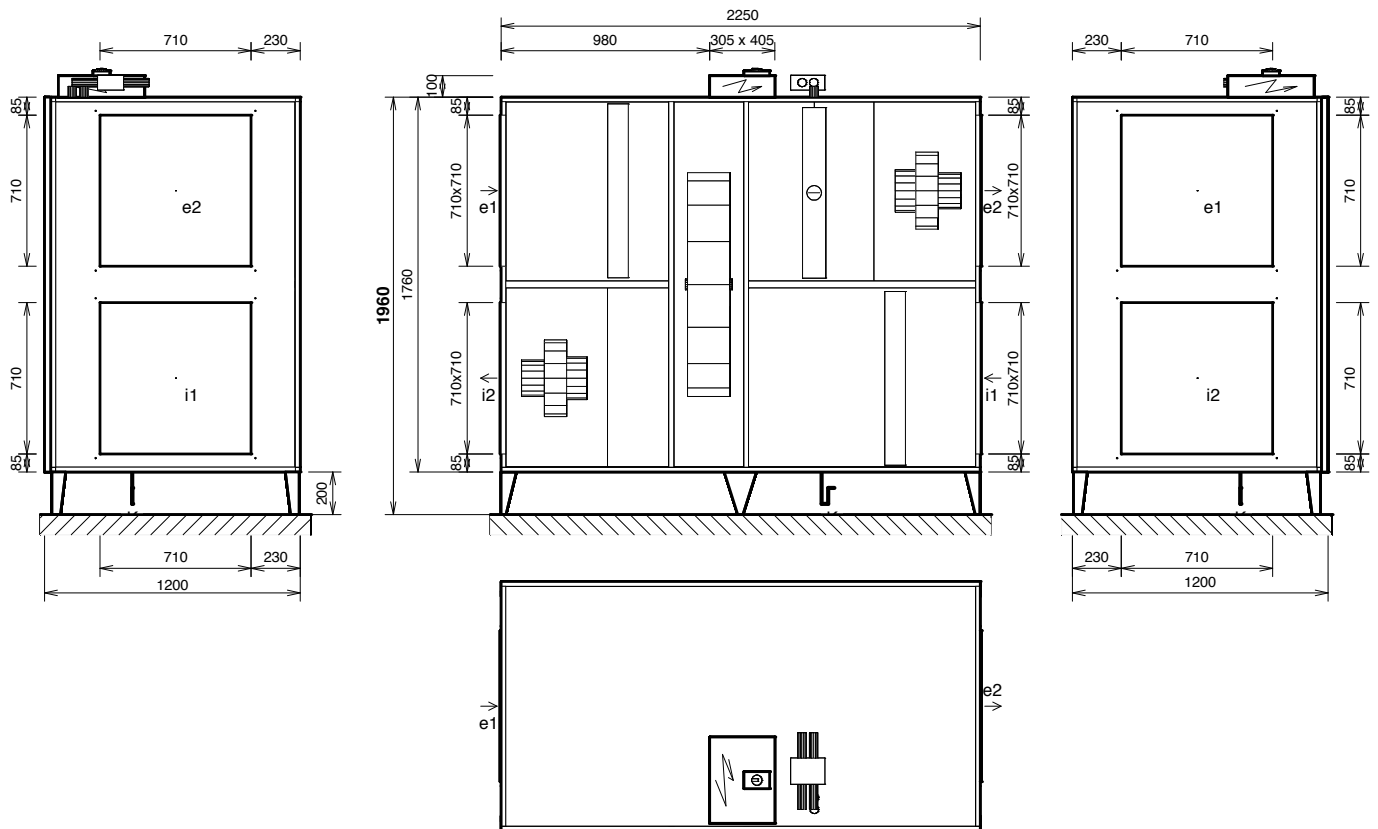

Connections	Type	Dimensions	Optional components
e1	e1- outdoor air (ODA)	710x710mm	Shutoff damper, Flexible connection
e2	e2- supply air (SUP)	710x710mm	Flexible connection
i1	i1- extract air (ETA)	710x710mm	Shutoff damper, Flexible connection
i2	i2- exhaust air (EHA)	710x710mm	Flexible connection
K	condensate drain	Ø 32 mm/40 mm	Condensate pump

Notice:

- Unit delivered as 1 piece
- Door is 3 parts
- Diagram is intended only for basic information, binding dimensions receive at device delivery, or on request from the manufacturer
- Bolt holes for duct connection (for one port): 4x M6

Duplexvent Rotary DV5000

Commercial MVHR with rotary thermal wheel - Indoor



KEY FEATURES

- Air volume up to 4700 m³/h at 200 Pa according to ErP 2018
- Highly efficient, certified by Eurovent rotary heat exchanger, up to 85% thermal efficiency
- Low SFP and energy saving EC fans
- Digital touchscreen or manual controller or BMS
- VAV control compatibility
- Filters: ePM2,5 65 % (F7), ePM10 70 % (M5) or Coarse 60 % (G4)
- Optional equipment: recirculation damper, heating or cooling coils, purge chamber
- Optional constant flow pressure mode
- 2 year warranty+

PERFORMANCE

Ventilation		Supply Air	Extract Air
Air volume @ 200 Pa	m ³ /h / l/s	4700 / 1306	4700 / 1306
Nominal voltage	V	400	400
Nominal power (at operation point)	kW	1.1	1
Fan Speed	min ⁻¹	2396	2377
Max power input	kW	2.5	2.5
Max current	A	3.8	3.8
Fan Type		EC	EC

Note: The figures above have been measured at 4700 m³/h and 200 Pa. Please use the Duplexvent Selection Software to calculate measurements at other performance levels.

AIR FLOW CURVE

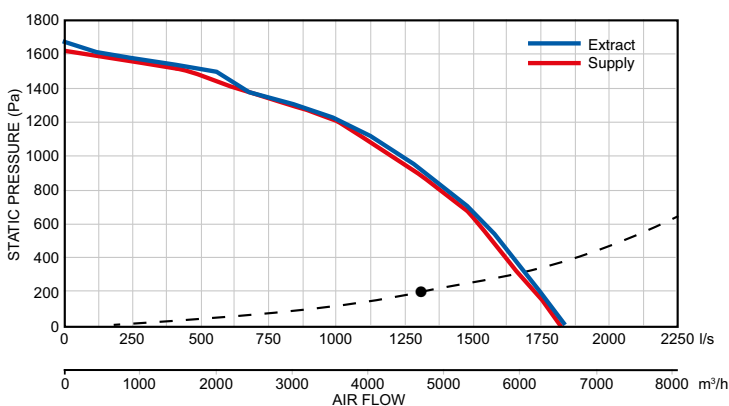

Heat Recovery		Supply Air	Extract Air
Air volume @ 200 Pa	m ³ /h / l/s	4700 / 1306	4700 / 1306
Temperature at inlet	°C	-5	20
Temperature at outlet	°C	14	2
Humidity at inlet	% RH	90	40
Humidity at outlet	% RH	38	95
Heat recovery efficiency winter/summer	%	74 / 75	
Humidity recovery efficiency winter/summer	%	40 / 0	
Total heat gain winter/summer	kW	34.9 / 7.2	
Sensible heat gain winter/summer	kW	28.5 / 7.0	
Latent heat gain winter/summer	kW	6.4 / 0	
Heat exchanger speed	RPM	10-13	
Type of heat exchanger		Thermal Rotary Wheel	
Part No.		90000727	

Note: The figures above have been measured at 4700 m³/h and 200 Pa. Please use the Duplexvent Selection Software to calculate measurements at other performance levels.

POWER CONSUMPTION

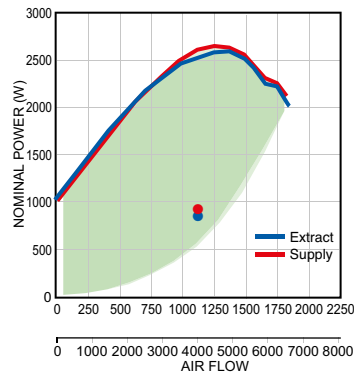

Note: Green area denotes power consumption range. Power consumption depends on system installation.
+ excludes motors. Motor warranty one year from date of purchase.

HEAT RECOVERY EFFICIENCY

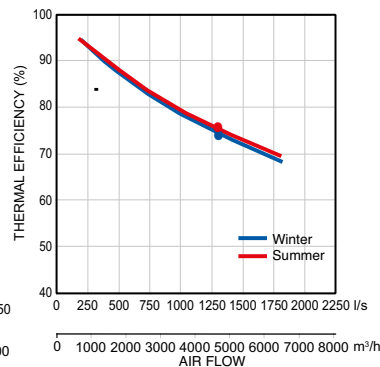

Sound Power Level L _w	Total	dB (A)							
		63 Hz	125 Hz	250 Hz	500 Hz	1 kHz	2 kHz	4 kHz	8 kHz
Outdoor air e1	66	40	60	61	59	57	52	47	27
Supply air e2	90	63	71	81	87	85	79	72	66
Extract air i1	66	40	60	62	59	57	53	48	27
Exhaust air i2	90	63	71	81	87	85	79	73	66
Breakout noise	65	45	48	63	60	54	42	36	<25
Sound Pressure Level L _p measured at 3m	44	<25	28	42	39	34	<25	<25	<25

Note: The figures above have been measured at 4700 m³/h and 200 Pa. Please use the Duplexvent Selection Software to calculate measurements at other performance levels.

Winter Operation:

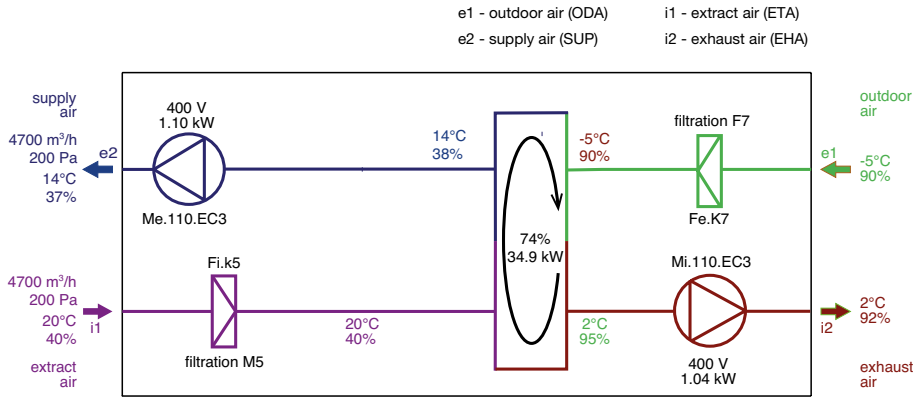

Note: AHU functions diagram. Inlet and outlet location may differ from actual position and port configuration.

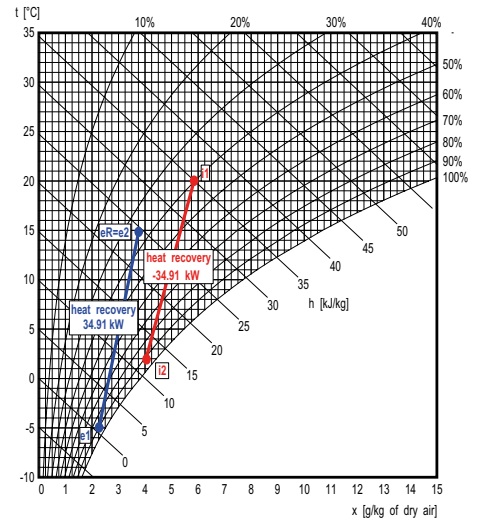

Supply

	Description	t [°C]	RH [%]
e1	Outdoor air	-5.0	90
e2	Supply air	14.1	37

Exhaust

	Description	t [°C]	RH [%]
i1	Extract Air	20.0	40
i2	Exhaust Air	2.5	92

Summer Operation:

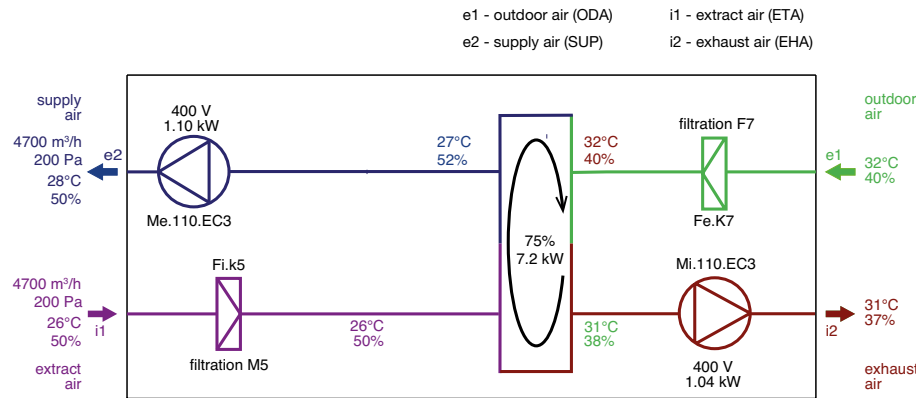

Note: AHU functions diagram. Inlet and outlet location may differ from actual position and port configuration.

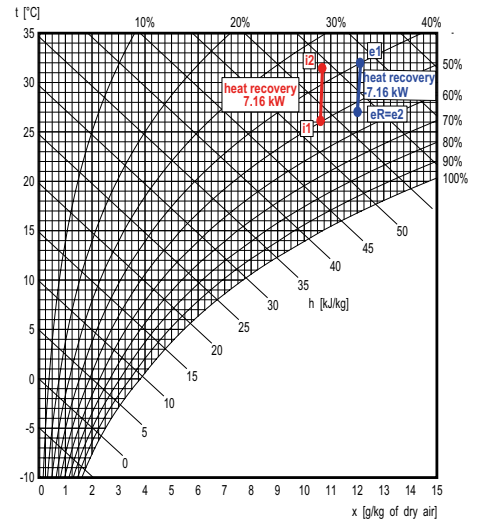

Supply

	Description	t [°C]	RH [%]
e1	Outdoor Air	32.0	40
e2	Supply Air	28.0	50

Exhaust

	Description	t [°C]	RH [%]
i1	Extract Air	32.0	50
i2	Exhaust Air	31.0	37

FILTERS

Filtration	Supply	Extract	Accessories (part of delivery)
Type	Pleated Cartridge		Pfe dirty filter pressure switch for supply air Pfi dirty filter pressure switch for extract air
Filtration class	ePM2,5 65 % (F7)	ePM10 70 % (M5)	
Number of filters	2	2	
Filter cartridge size	750x495x96	750x495x96	

Duplexvent Rotary DV5000

Commercial MVHR with rotary thermal wheel - Indoor

OPTIONAL ACCESSORIES

ELECTRIC HEATER

Electric pre-heater		Supply
Air volume	m ³ /h / l/s	4700 / 1306
Maximum heating capacity	kW	13.5
Voltage	V	400
Connection ports	mm	300x600

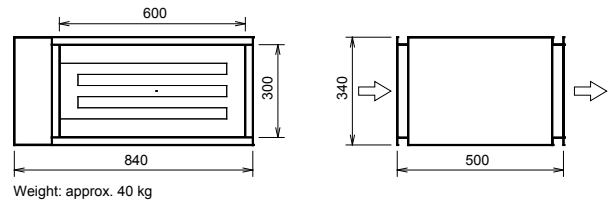

WATER HEATING COIL

Water heating coil		Supply
Heating medium		Water
Air volume	m ³ /h / l/s	4700 / 1306
Temperature at inlet (after heat recovery)	°C	14
Temperature at outlet (downstream of the heater)	°C	19
Heating capacity	kW	9.2
Heating medium temperature drop	°C	70 / 50
Medium flow (from source)	l/h	395
Connection dimension (hydraulic kit)		1" female

Note: The figures above have been measured at 4700 m³/h and 200 Pa. Please use the Duplexvent Selection Software to calculate measurements at other performance levels.

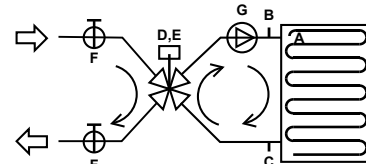

- A Freeze protection thermostat 016-H6929-109-6m
 - B Air vent automatic
 - C Sludge valve plug
 - Hydraulic kit: RE-TPO4. LM24A-SR**
 - D Mixing valve IVAR.MIX4, Kv 12, 1"
 - E Actuator LM24A-SR
 - F Globe valve 1"
 - G Pump WILO YONOS PARA RS 20/6- RKC
- 1 - Delivered separately
2 - Fitted and connected

HEATING CAPACITY

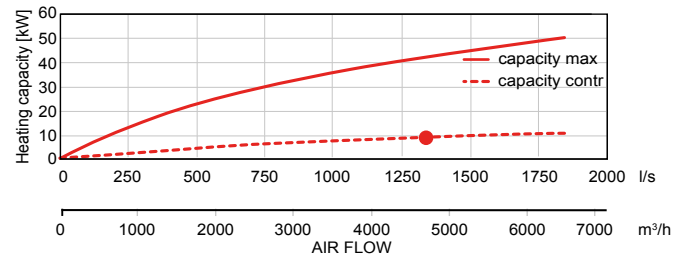

WATER COOLING COIL

Water cooling coil		Supply
Cooling medium		21% Ethylene glycol
Air volume	m ³ /h / l/s	4700 / 1306
Temperature at inlet (after heat recovery)	°C	27
Temperature at outlet (downstream of the cooling coil)	°C	16
Inlet relative humidity (after heat recovery)	% RH	52
Outlet relative humidity (downstream of the cooling coil)	% RH	85
Cooling capacity	kW	25.4
Condensate production	l/h	12
Water temperature drop	°C	6 / 12
Medium flow (at max. capacity)	l/h	4270
Medium-side pressure drop		
in heat exchanger	kPa	33.17
in valve	kPa	17.83
Connection dimension		1" female

Note: The figures above have been measured at 4700 m³/h and 200 Pa. Please use the Duplexvent Selection Software to calculate measurements at other performance levels.

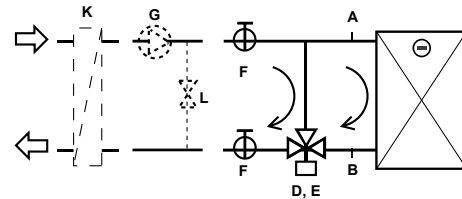

- A Air vent automatic
 - B Sludge valve plug
 - Hydraulic kit: R-CHW3.E.TR 24-SR**
 - D 3-way ball valve R3020-B1
 - E Actuator TR 24-SR
 - F Globe valve 1"
 - G Pump
 - L Water bypass
 - K Coil water/ethylene glycol
- Others:
- 1 - Delivered separately
2 - Fitted and connected
3 - Not part of delivery

COOLING CAPACITY

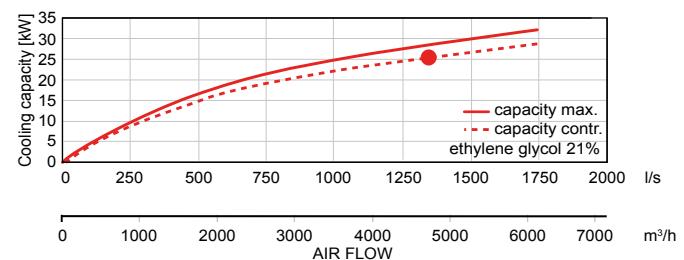

DX COIL

DX coil		Supply
Air volume	m ³ /h / l/s	4700 / 1306
Temperature at inlet (after heat recovery)	°C	27
Temperature at outlet (downstream of the DX coil)	°C	16
Inlet relative humidity (after heat recovery)	% RH	52
Outlet relative humidity (downstream of the DX coil)	% RH	80
Cooling capacity	kW	21.40
Condensate production	l/h	15
Refrigerant type		R410A
Evaporating temperature	°C	9

Note: The figures above have been measured at 4700 m³/h and 200 Pa. Please use the Duplexvent Selection Software to calculate measurements at other performance levels.

COOLING CAPACITY

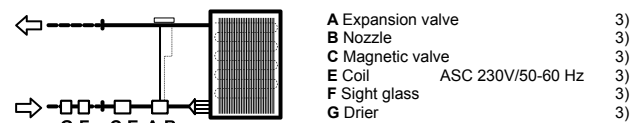
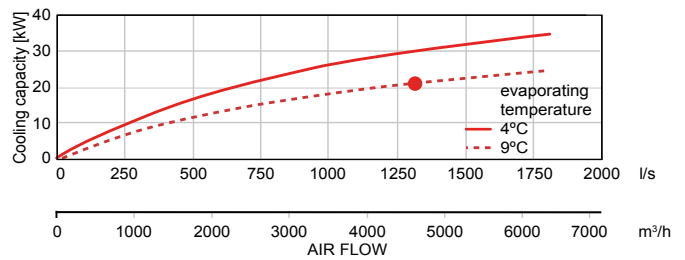

3 Not part of delivery, recommended type mentioned

DIMENSIONS

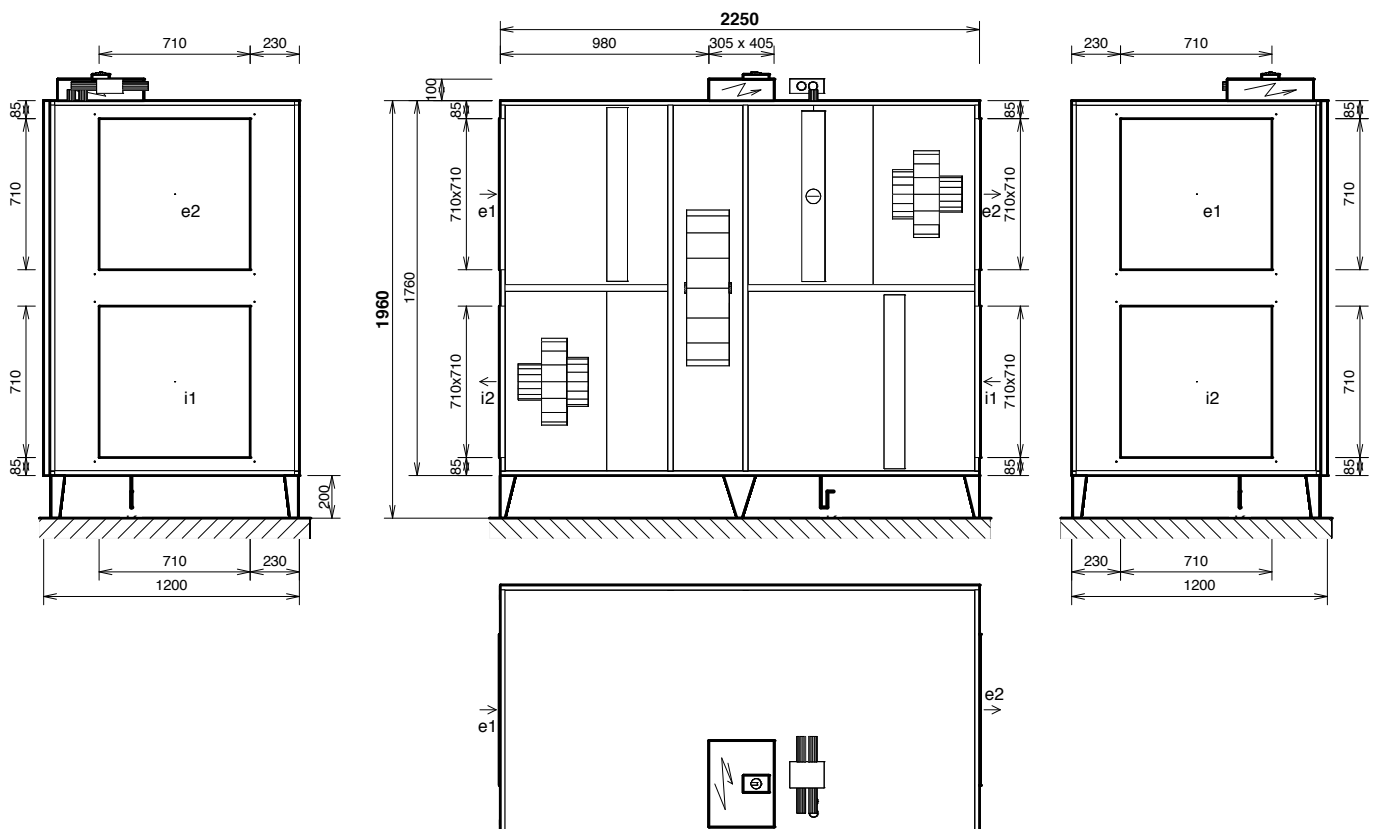

Connections	Type	Dimensions	Optional components
e1	e1- outdoor air (ODA)	710x710mm	Shutoff damper, Flexible connection
e2	e2- supply air (SUP)	710x710mm	Flexible connection
i1	i1- extract air (ETA)	710x710mm	Shutoff damper, Flexible connection
i2	i2- exhaust air (EHA)	710x710mm	Flexible connection
K	condensate drain	Ø 32 mm/40 mm	Condensate pump

Notice:

- Unit delivered as 1 piece
- Door is 3 parts
- Diagram is intended only for basic information, binding dimensions receive at device delivery, or on request from the manufacturer
- Bolt holes for duct connection (for one port): 4x M6

Duplexvent Rotary DV8000

Commercial MVHR with rotary thermal wheel - Indoor

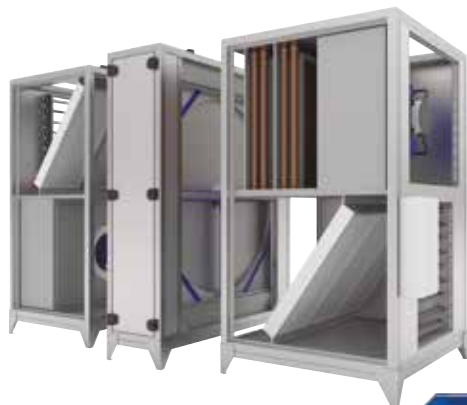

KEY FEATURES

- Air volume up to 7000 m³/h at 200 Pa according to ErP 2018
- Highly efficient, certified by Eurovent rotary heat exchanger, up to 85% thermal efficiency
- Low SFP and energy saving EC fans
- Digital touchscreen or manual controller or BMS
- VAV control compatibility
- Filters: ePM2,5 65 % (F7), ePM10 70 % (M5) or Coarse 60 % (G4)
- Optional equipment: recirculation damper, heating or cooling coils, purge chamber
- Optional constant flow pressure mode
- 2 year warranty+

PERFORMANCE

Ventilation		Supply Air	Extract Air
Air volume @ 400 Pa	m ³ /h / l/s	7000 / 1944	7000 / 1944
Nominal voltage	V	400	400
Nominal power (at operation point)	kW	2.2	2
Fan Speed	min ⁻¹	1962	1906
Max power input	kW	5.2	5.2
Max current	A	8.4	8.4
Fan Type		EC	EC

Note: The figures above have been measured at 7000 m³/h and 400 Pa. Please use the Duplexvent Selection Software to calculate measurements at other performance levels.

AIR FLOW CURVE

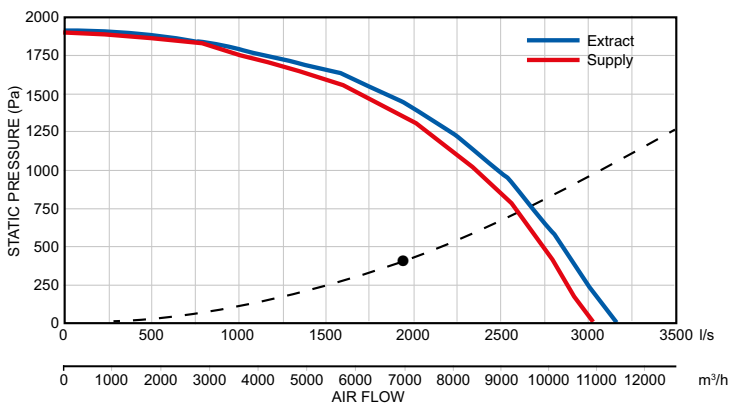

Heat Recovery		Supply Air	Extract Air
Air volume @ 400 Pa	m ³ /h / l/s	7000 / 1944	7000 / 1944
Temperature at inlet	°C	-5	20
Temperature at outlet	°C	14	3
Humidity at inlet	% RH	90	40
Humidity at outlet	% RH	31	100
Heat recovery efficiency winter/summer	%	75 / 73	
Humidity recovery efficiency winter/summer	%	22 / 0	
Total heat gain winter/summer	kW	47.7 / 10.4	
Sensible heat gain winter/summer	kW	43.0 / 10.0	
Latent heat gain winter/summer	kW	4.7 / 0	
Heat exchanger speed	RPM	10-13	
Type of heat exchanger		Thermal Rotary Wheel	
Part No.		90000568	

Note: The figures above have been measured at 7000 m³/h and 400 Pa. Please use the Duplexvent Selection Software to calculate measurements at other performance levels.

POWER CONSUMPTION

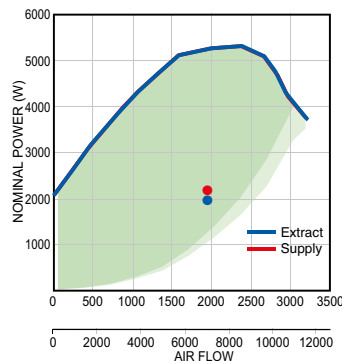

Note: Green area denotes power consumption range. Power consumption depends on system installation.
+ excludes motors. Motor warranty one year from date of purchase.

HEAT RECOVERY EFFICIENCY

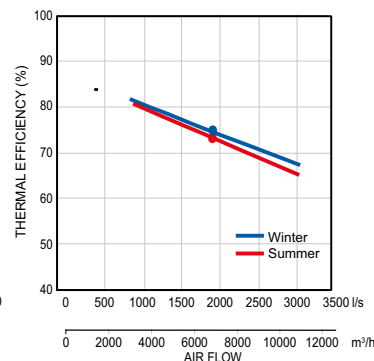

Sound Power Level L _w	Total	63 Hz	125 Hz	250 Hz	500 Hz	1 kHz	2 kHz	4 kHz	8 kHz
	dB (A)								
Outdoor air e1	77	54	64	73	72	68	63	55	51
Supply air e2	94	71	77	84	89	90	85	78	70
Extract air i1	77	53	63	73	73	68	63	54	51
Exhaust air i2	94	71	77	84	89	90	85	77	70
Breakout noise	71	44	48	67	64	62	62	58	42
Sound Pressure Level L _p measured at 3m	50	<25	27	46	44	41	42	37	<25

Note: The figures above have been measured at 7000 m³/h and 400 Pa. Please use the Duplexvent Selection Software to calculate measurements at other performance levels.

Winter Operation:

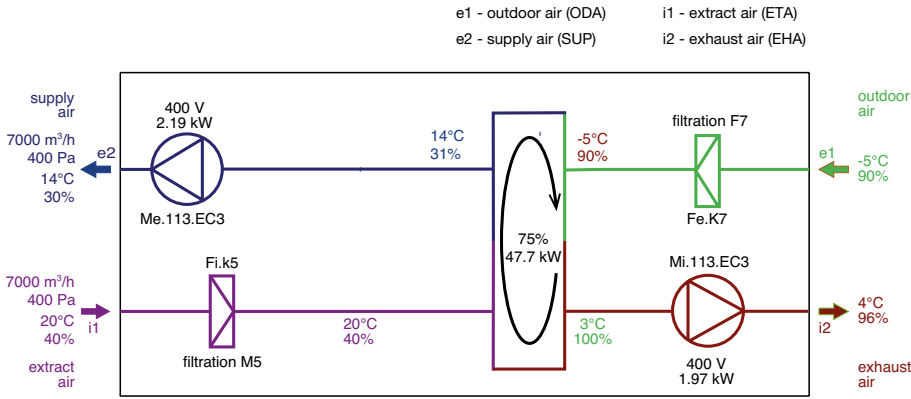

Note: AHU functions diagram. Inlet and outlet location may differ from actual position and port configuration.

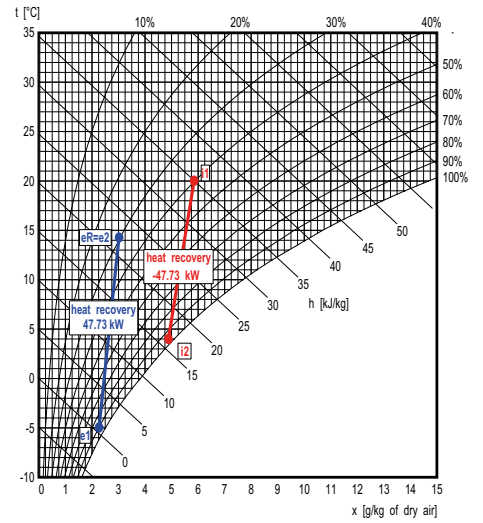

Supply

	Description	t [°C]	RH [%]
e1	Outdoor air	-5.0	90
e2	Supply air	14.4	30

Exhaust

	Description	t [°C]	RH [%]
i1	Extract Air	20.0	40
i2	Exhaust Air	4.1	96

Summer Operation:

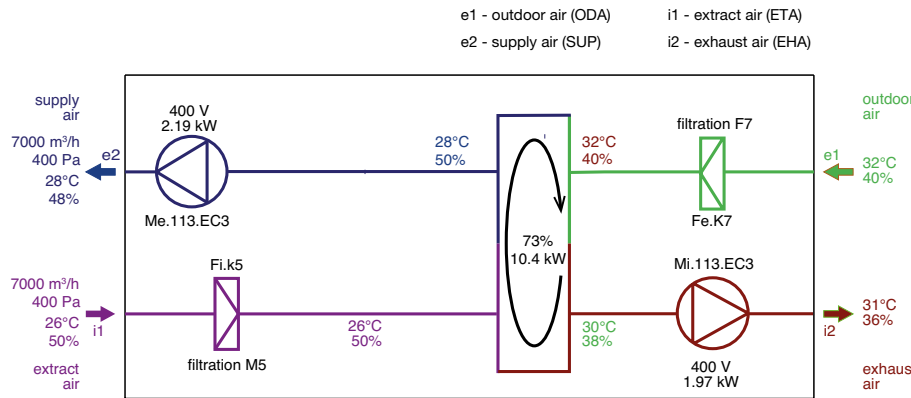

Note: AHU functions diagram. Inlet and outlet location may differ from actual position and port configuration.

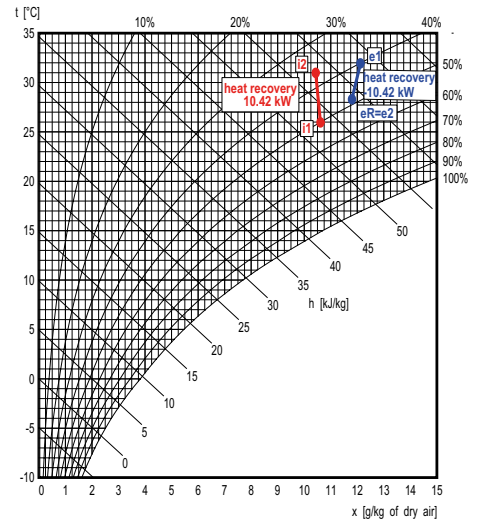

Supply

	Description	t [°C]	RH [%]
e1	Outdoor Air	32.0	40
e2	Supply Air	28.4	48

Exhaust

	Description	t [°C]	RH [%]
i1	Extract Air	26.0	50
i2	Exhaust Air	31.0	36

FILTERS

Filtration	Supply	Extract	Accessories (part of delivery)
Type	Pleated Cartridge		Pfe dirty filter pressure switch for supply air Pfi dirty filter pressure switch for extract air
Filtration class	ePM2,5 65 % (F7)	ePM10 70 % (M5)	
Number of filters	2	2	
Filter cartridge size	750x495x96	750x495x96	

Duplexvent Rotary DV8000

Commercial MVHR with rotary thermal wheel - Indoor

OPTIONAL ACCESSORIES

ELECTRIC HEATER

Electric pre-heater		Supply
Air volume	m ³ /h / l/s	7000 / 1944
Maximum heating capacity	kW	54.0
Voltage	V	400
Connection ports	mm	500x800

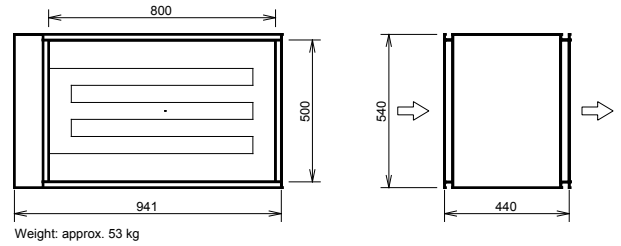

WATER HEATING COIL

Water heating coil		Supply
Heating medium		Water
Air volume	m ³ /h / l/s	7000 / 1944
Temperature at inlet (after heat recovery)	°C	14
Temperature at outlet (downstream of the heater)	°C	19
Heating capacity	kW	13.4
Heating medium temperature drop	°C	70 / 50
Medium flow (from source)	l/h	578
Connection dimension (hydraulic kit)		1" female

Note: The figures above have been measured at 7000 m³/h and 400 Pa. Please use the Duplexvent Selection Software to calculate measurements at other performance levels.

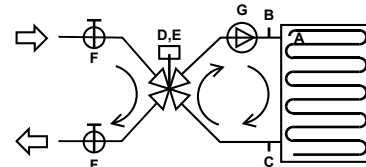

- A Freeze protection thermostat 016-H6929-109-6m
 - B Air vent automatic
 - C Sludge valve plug
 - Hydraulic kit: RE-TPO4. LM24A-SR**
 - D Mixing valve IVAR.MIX4, Kv 12, 1"
 - E Actuator LM24A-SR
 - F Globe valve 1"
 - G Pump WILO YONOS PARA RS 20/6- RKC
- 1 - Delivered separately
2 - Fitted and connected

HEATING CAPACITY

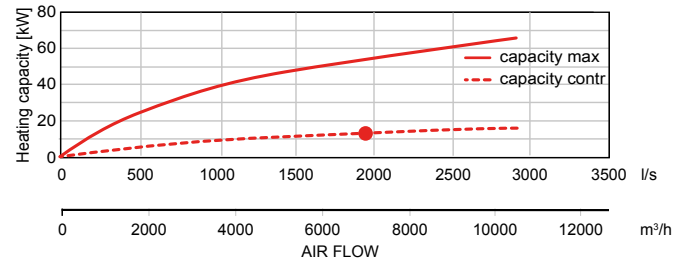

WATER COOLING COIL

Water cooling coil		Supply
Cooling medium		21% Ethylene glycol
Air volume	m ³ /h / l/s	7000 / 1944
Temperature at inlet (after heat recovery)	°C	28
Temperature at outlet (downstream of the cooling coil)	°C	16
Inlet relative humidity (after heat recovery)	% RH	50
Outlet relative humidity (downstream of the cooling coil)	% RH	87
Cooling capacity	kW	36.8
Condensate production	l/h	16
Water temperature drop	°C	6 / 12
Medium flow (at max. capacity)	l/h	5800
Medium-side pressure drop		
in heat exchanger	kPa	30.31
in valve	kPa	32.88
Connection dimension		1" female

Note: The figures above have been measured at 7000 m³/h and 400 Pa. Please use the Duplexvent Selection Software to calculate measurements at other performance levels.

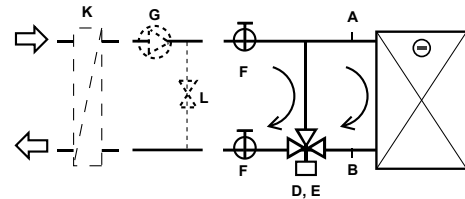

- A Air vent automatic
 - B Sludge valve plug
 - Hydraulic kit: R-CHW3.E.TR 24-SR**
 - D 3-way ball valve R3020-B1
 - E Actuator TR 24-SR
 - F Globe valve 1"
 - Others:**
 - G Pump
 - L Water bypass
 - K Coil water/ethylene glycol
- 1 - Delivered separately
2 - Fitted and connected
3 - Not part of delivery

COOLING CAPACITY

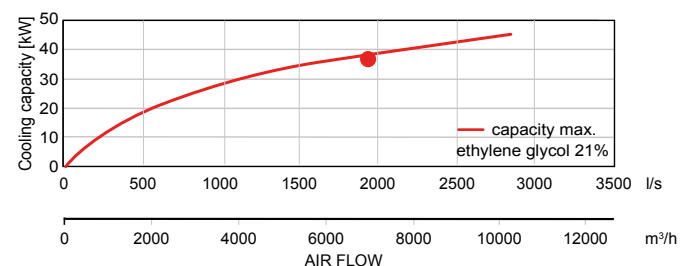

DX COIL

DX coil		Supply
Air volume	m ³ /h / l/s	7000 / 1944
Temperature at inlet (after heat recovery)	°C	28
Temperature at outlet (downstream of the DX coil)	°C	16
Inlet relative humidity (after heat recovery)	% RH	50
Outlet relative humidity (downstream of the DX coil)	% RH	84
Cooling capacity	kW	32.78
Condensate production	l/h	19
Refrigerant type		R410A
Evaporating temperature	°C	6

Note: The figures above have been measured at 7000 m³/h and 400 Pa. Please use the Duplexvent Selection Software to calculate measurements at other performance levels.

COOLING CAPACITY

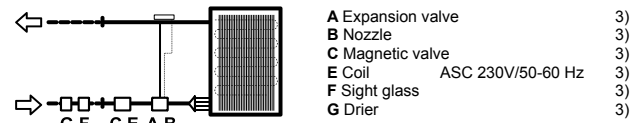
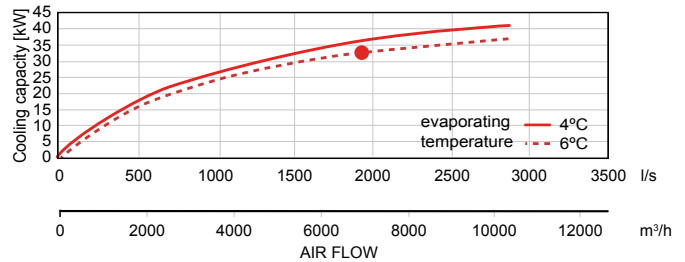

3 Not part of delivery, recommended type mentioned

DIMENSIONS

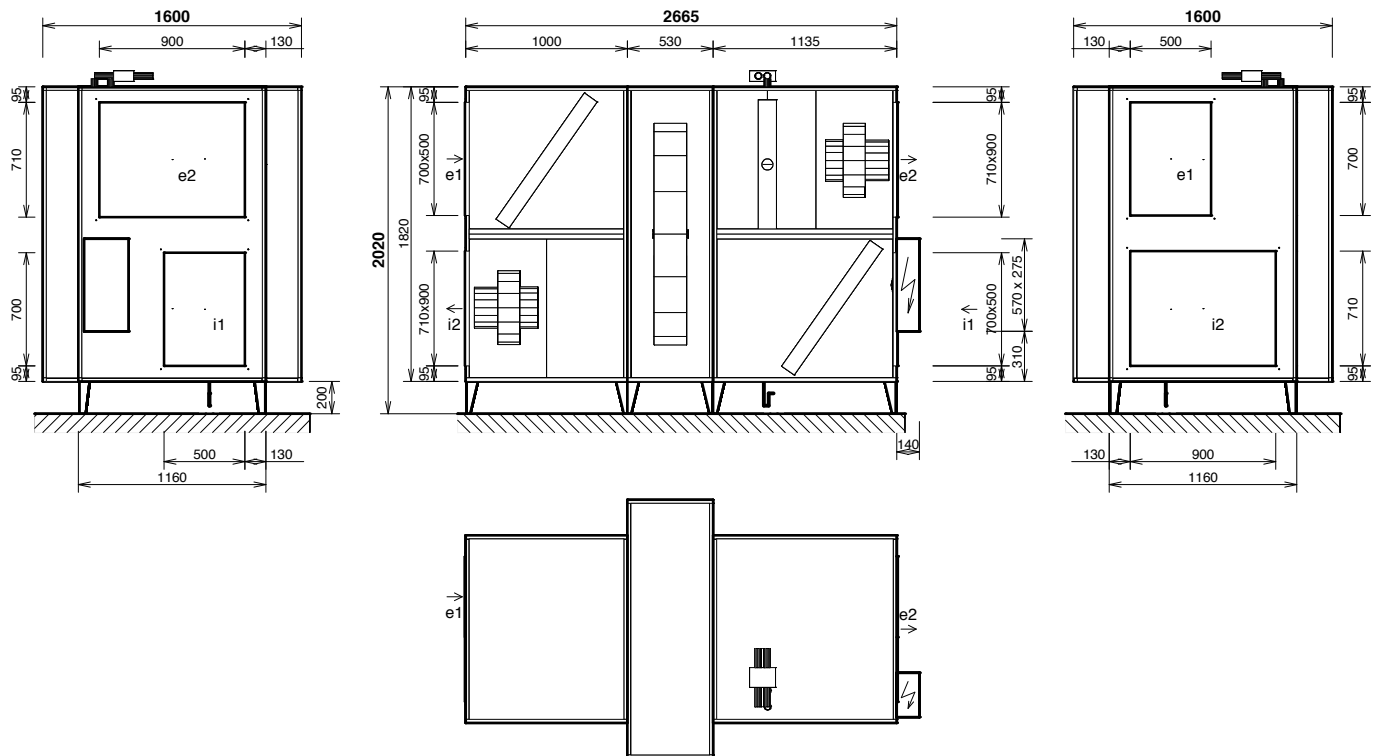

Connections	Type	Dimensions	Optional components
e1	e1- outdoor air (ODA)	700x500mm	Shutoff damper, Flexible connection
e2	e2- supply air (SUP)	710x900mm	Flexible connection
i1	i1- extract air (ETA)	700x500mm	Shutoff damper, Flexible connection
i2	i2- exhaust air (EHA)	710x900mm	Flexible connection
K	condensate drain	Ø 32 mm/40 mm	Condensate pump

Notice:

- Unit delivered in three parts
- Door is 3 parts
- Diagram is intended only for basic information, binding dimensions receive at device delivery, or on request from the manufacturer
- Bolt holes for duct connection (for one port): 4x M6

Duplexvent Rotary DV12000

Commercial MVHR with rotary thermal wheel - Indoor

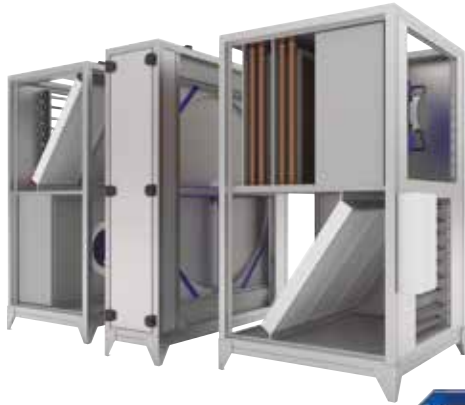

KEY FEATURES

- Air volume up to 9000 m³/h at 200 Pa according to ErP 2018
- Highly efficient, certified by Eurovent rotary heat exchanger, up to 85% thermal efficiency
- Low SFP and energy saving EC fans
- Digital touchscreen or manual controller or BMS
- VAV control compatibility
- Filters: ePM2,5 65 % (F7), ePM10 70 % (M5) or Coarse 60 % (G4)
- Optional equipment: recirculation damper, heating or cooling coils, purge chamber
- Optional constant flow pressure mode
- 2 year warranty+

PERFORMANCE

Ventilation		Supply Air	Extract Air
Air volume @ 400 Pa	m ³ /h / l/s	9000 / 2500	9000 / 2500
Nominal voltage	V	400	400
Nominal power (at operation point)	kW	2.7	2.6
Fan Speed	min ⁻¹	1747	1718
Max power input	kW	5.4	5.4
Max current	A	8.6	8.6
Fan Type		EC	EC

Note: The figures above have been measured at 9000 m³/h and 400 Pa. Please use the Duplexvent Selection Software to calculate measurements at other performance levels.

AIR FLOW CURVE

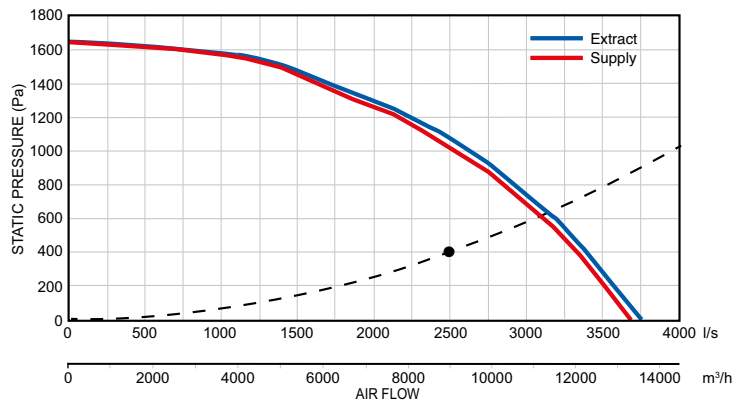

Heat Recovery		Supply Air	Extract Air
Air volume @ 400 Pa	m ³ /h / l/s	9000 / 2500	9000 / 2500
Temperature at inlet	°C	-5	20
Temperature at outlet	°C	14	3
Humidity at inlet	% RH	90	40
Humidity at outlet	% RH	31	100
Heat recovery efficiency winter/summer	%	75 / 73	
Humidity recovery efficiency winter/summer	%	22 / 0	
Total heat gain winter/summer	kW	61.3 / 13.4	
Sensible heat gain winter/summer	kW	55.3 / 13	
Latent heat gain winter/summer	kW	6.0 / 0	
Heat exchanger speed	RPM	10-13	
Type of heat exchanger		Thermal Rotary Wheel	
Part No.		90000569	

Note: The figures above have been measured at 9000 m³/h and 400 Pa. Please use the Duplexvent Selection Software to calculate measurements at other performance levels.

POWER CONSUMPTION

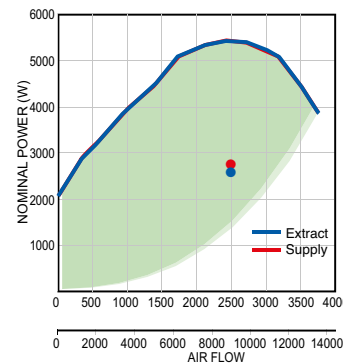

Note: Green area denotes power consumption range. Power consumption depends on system installation.
+ excludes motors. Motor warranty one year from date of purchase.

HEAT RECOVERY EFFICIENCY

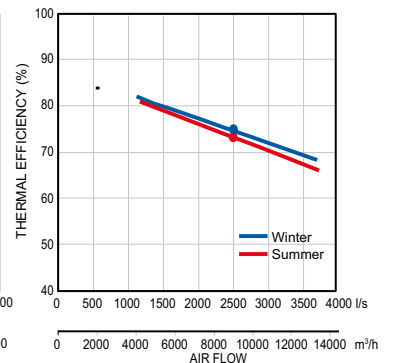

Sound Power Level L _w	Total	63 Hz	125 Hz	250 Hz	500 Hz	1 kHz	2 kHz	4 kHz	8 kHz
	dB (A)								
Outdoor air e1	76	54	66	71	72	69	60	50	39
Supply air e2	97	74	80	84	92	94	88	80	69
Extract air i1	76	54	66	71	72	69	60	49	39
Exhaust air i2	97	73	80	84	91	93	87	80	69
Breakout noise	66	46	55	60	58	61	58	54	39
Sound Pressure Level L _p measured at 3m	44	25	35	39	38	40	37	33	<25

Note: The figures above have been measured at 9000 m³/h and 400 Pa. Please use the Duplexvent Selection Software to calculate measurements at other performance levels.

Winter Operation:

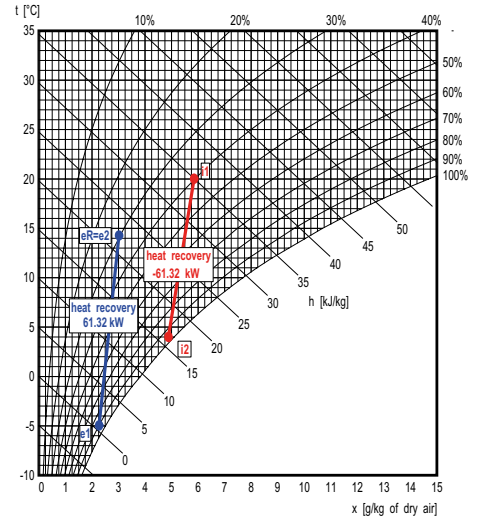
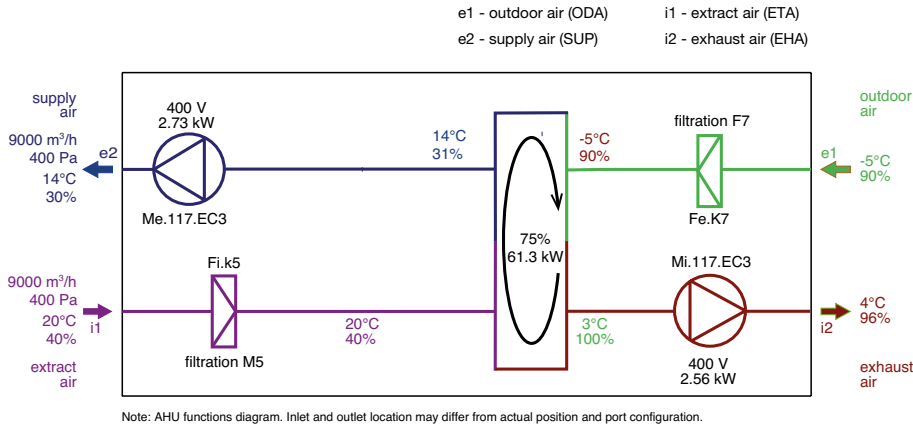

Supply

	Description	t [°C]	RH [%]
e1	Outdoor air	-5.0	90
e2	Supply air	14.4	30

Exhaust

	Description	t [°C]	RH [%]
i1	Extract Air	20.0	40
i2	Exhaust Air	4.1	96

Summer Operation:

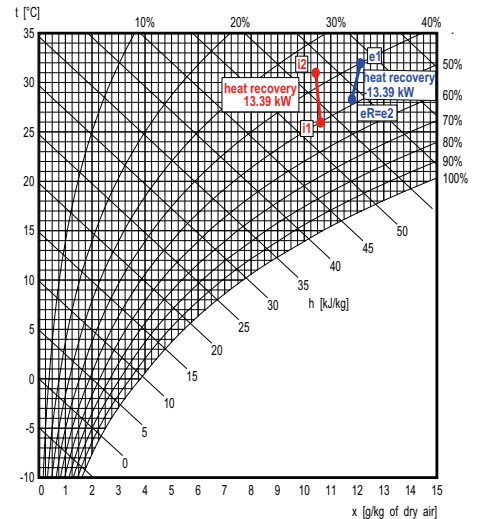
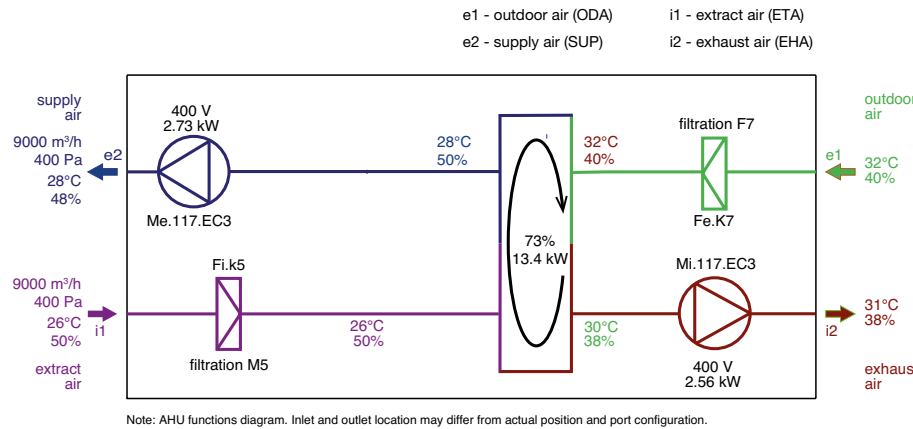

Supply

	Description	t [°C]	RH [%]
e1	Outdoor Air	32.0	40
e2	Supply Air	28.3	48

Exhaust

	Description	t [°C]	RH [%]
i1	Extract Air	26.0	50
i2	Exhaust Air	31.0	36

FILTERS

Filtration	Supply	Extract	Accessories (part of delivery)
Type	Pleated Cartridge		Pfe dirty filter pressure switch for supply air Pfi dirty filter pressure switch for extract air
Filtration class	ePM2,5 65 % (F7)	ePM10 70 % (M5)	
Number of filters	pcs 3	3	
Filter cartridge size	mm 1000x440x96	1000x440x96	

Duplexvent Rotary DV12000

Commercial MVHR with rotary thermal wheel - Indoor

OPTIONAL ACCESSORIES

ELECTRIC HEATER

Electric pre-heater		Supply
Air volume	m ³ /h / l/s	9000 / 2500
Maximum heating capacity	kW	54.0
Voltage	V	400
Connection ports	mm	500x800

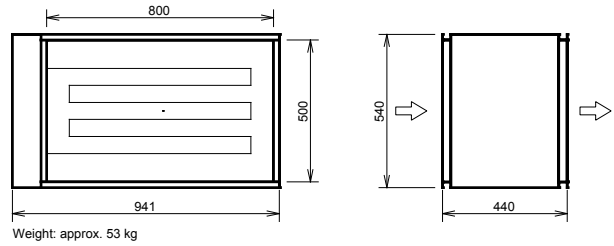

WATER HEATING COIL

Water heating coil		Supply
Heating medium		Water
Air volume	m ³ /h / l/s	9000 / 2500
Temperature at inlet (after heat recovery)	°C	14
Temperature at outlet (downstream of the heater)	°C	19
Heating capacity	kW	17.4
Heating medium temperature drop	°C	70 / 50
Medium flow (from source)	l/h	752
Connection dimension (hydraulic kit)		1" female

Note: The figures above have been measured at 9000 m³/h and 400 Pa. Please use the Duplexvent Selection Software to calculate measurements at other performance levels.

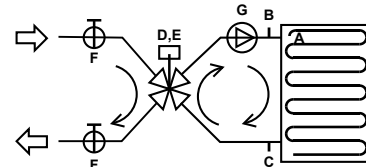

- A Freeze protection thermostat 016-H6929-109-6m
 - B Air vent automatic
 - C Sludge valve plug
 - Hydraulic kit: RE-TPO4. LM24A-SR
 - D Mixing valve IVAR.MIX4, Kv 12, 1"
 - E Actuator LM24A-SR
 - F Globe valve 1"
 - G Pump WILO YONOS PARA RS 20/6- RKC
- 1 - Delivered separately
2 - Fitted and connected

HEATING CAPACITY

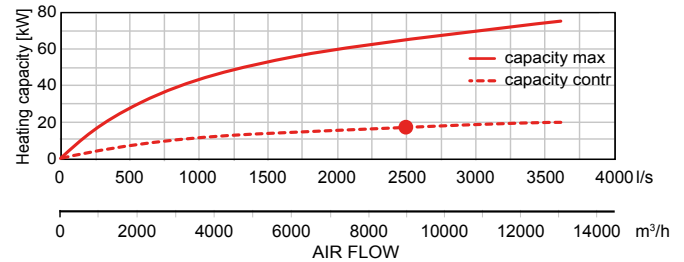

WATER COOLING COIL

Water cooling coil		Supply
Cooling medium		21% Ethylene glycol
Air volume	m ³ /h / l/s	9000 / 2500
Temperature at inlet (after heat recovery)	°C	28
Temperature at outlet (downstream of the cooling coil)	°C	17
Inlet relative humidity (after heat recovery)	% RH	50
Outlet relative humidity (downstream of the cooling coil)	% RH	87
Cooling capacity	kW	44.6
Condensate production	l/h	17
Water temperature drop	°C	6 / 12
Medium flow (at max. capacity)	l/h	6760
Medium-side pressure drop		
in heat exchanger	kPa	16.09
in valve	kPa	44.65
Connection dimension		1" female

Note: The figures above have been measured at 9000 m³/h and 400 Pa. Please use the Duplexvent Selection Software to calculate measurements at other performance levels.

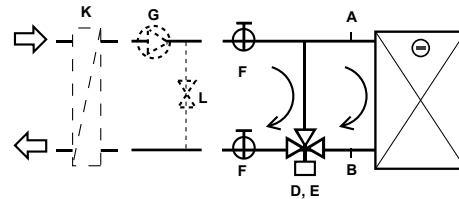

- A Air vent automatic
 - B Sludge valve plug
 - Hydraulic kit: R-CHW3.E.TR 24-SR
 - D 3-way ball valve R3020-B1
 - E Actuator TR 24-SR
 - F Globe valve 1"
 - Others:
 - G Pump
 - L Water bypass
 - K Coil water/ethylene glycol
- 1 - Delivered separately
2 - Fitted and connected
3 - Not part of delivery

COOLING CAPACITY

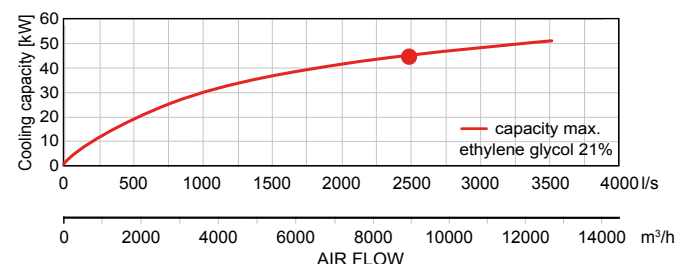

DX COIL

DX coil		Supply
Air volume	m ³ /h / l/s	9000 / 2500
Temperature at inlet (after heat recovery)	°C	28
Temperature at outlet (downstream of the DX coil)	°C	17
Inlet relative humidity (after heat recovery)	% RH	50
Outlet relative humidity (downstream of the DX coil)	% RH	78
Cooling capacity	kW	40.95
Condensate production	l/h	30
Refrigerant type		R410A
Evaporating temperature	°C	8

Note: The figures above have been measured at 9000 m³/h and 400 Pa. Please use the Duplexvent Selection Software to calculate measurements at other performance levels.

COOLING CAPACITY

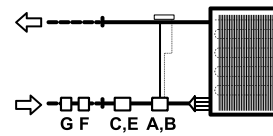
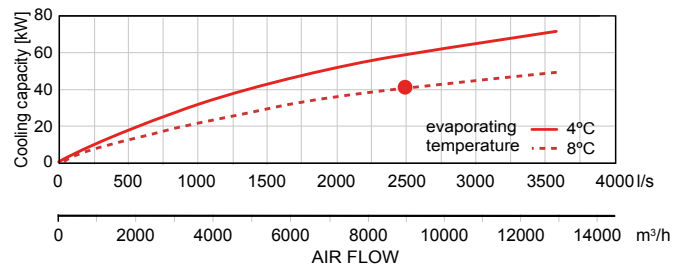

- A Expansion valve (3)
- B Nozzle (3)
- C Magnetic valve (3)
- E Coil ASC 230V/50-60 Hz (3)
- F Sight glass (3)
- G Drier (3)

3 Not part of delivery, recommended type mentioned

DIMENSIONS

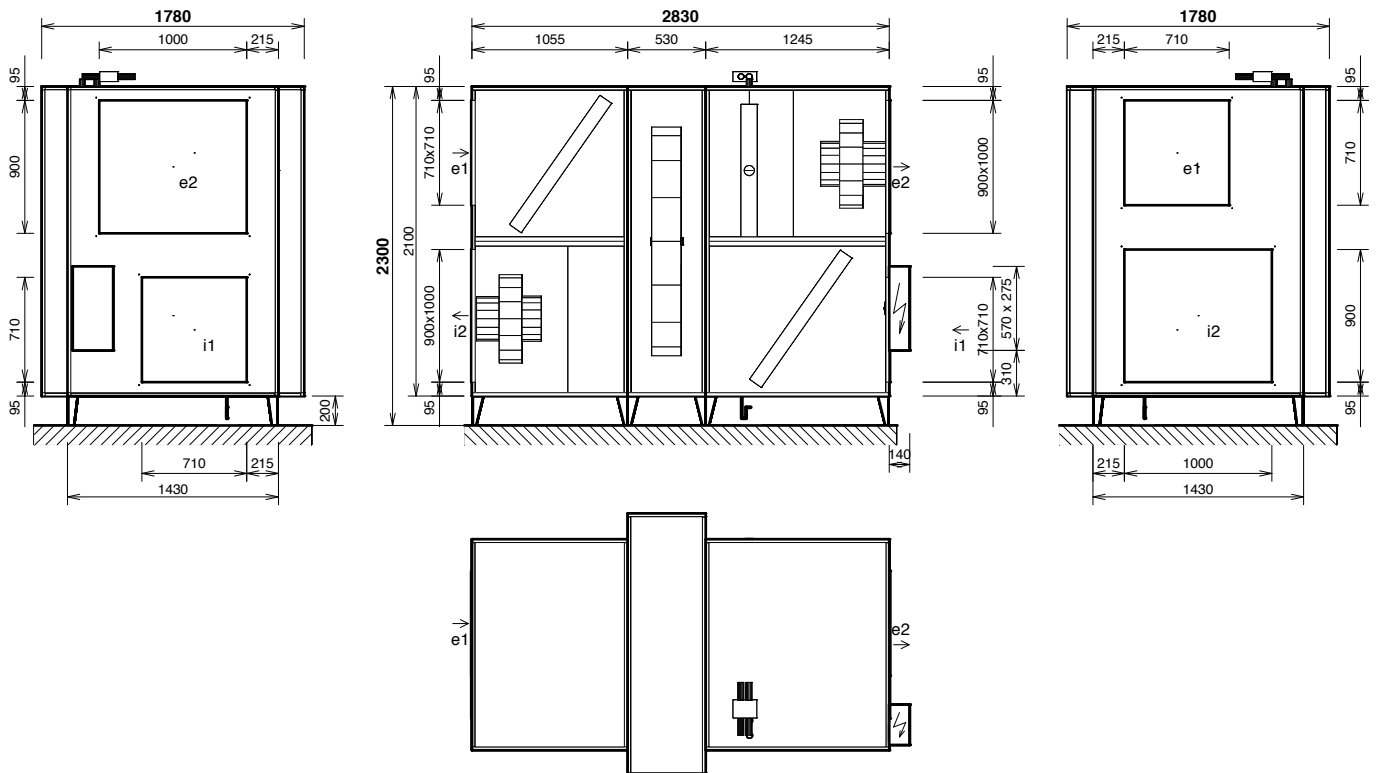

Connections	Type	Dimensions	Optional components
e1	e1- outdoor air (ODA)	710x710mm	Shutoff damper, Flexible connection
e2	e2- supply air (SUP)	900x1000mm	Flexible connection
i1	i1- extract air (ETA)	710x710mm	Shutoff damper, Flexible connection
i2	i2- exhaust air (EHA)	900x1000mm	Flexible connection
K	condensate drain	Ø 32 mm/40 mm	Condensate pump

Notice:

- Unit delivered in three parts
- Door is 3 parts
- Diagram is intended only for basic information, binding dimensions receive at device delivery, or on request from the manufacturer
- Bolt holes for duct connection (for one port): 4x M6

Duplexvent Rotary DV15000

Commercial MVHR with rotary thermal wheel - Indoor

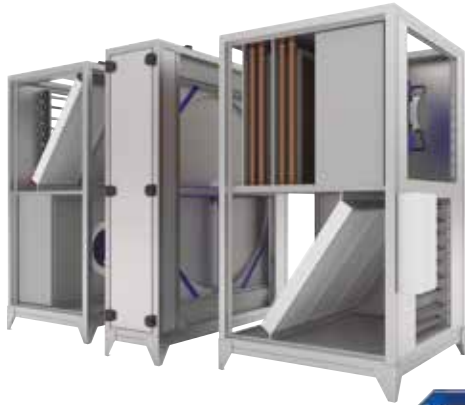

KEY FEATURES

- Air volume up to 11000 m³/h at 200 Pa according to ErP 2018
- Highly efficient, certified by Eurovent rotary heat exchanger, up to 85% thermal efficiency
- Low SFP and energy saving EC fans
- Digital touchscreen or manual controller or BMS
- VAV control compatibility
- Filters: ePM2,5 65 % (F7), ePM10 70 % (M5) or Coarse 60 % (G4)
- Optional equipment: recirculation damper, heating or cooling coils, purge chamber
- Optional constant flow pressure mode
- 2 year warranty+

PERFORMANCE

Ventilation		Supply Air	Extract Air
Air volume @ 400 Pa	m ³ /h / l/s	11000 / 3056	11000 / 3056
Nominal voltage	V	400	400
Nominal power (at operation point)	kW	3.5	3
Fan Speed	min ⁻¹	1563	1496
Max power input	kW	5.4	5.4
Max current	A	9.4	9.4
Fan Type		EC	EC

Note: The figures above have been measured at 11000 m³/h and 400 Pa. Please use the Duplexvent Selection Software to calculate measurements at other performance levels.

AIR FLOW CURVE

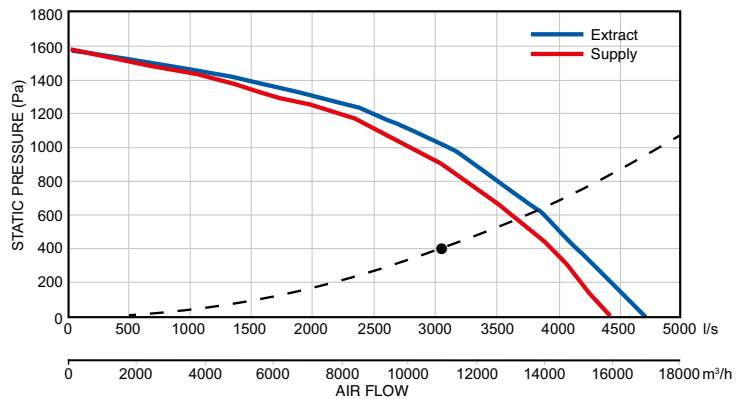

Heat Recovery		Supply Air	Extract Air
Air volume @ 400 Pa	m ³ /h / l/s	11000 / 3056	11000 / 3056
Temperature at inlet	°C	-5	20
Temperature at outlet	°C	14	4
Humidity at inlet	% RH	90	40
Humidity at outlet	% RH	31	100
Heat recovery efficiency winter/summer	%	74 / 73	
Humidity recovery efficiency winter/summer	%	20 / 0	
Total heat gain winter/summer	kW	74.0 / 16.3	
Sensible heat gain winter/summer	kW	67.2 / 16	
Latent heat gain winter/summer	kW	6.8 / 0	
Heat exchanger speed	RPM	10-13	
Type of heat exchanger		Thermal Rotary Wheel	
Part No.		90000570	

Note: The figures above have been measured at 11000 m³/h and 400 Pa. Please use the Duplexvent Selection Software to calculate measurements at other performance levels.

POWER CONSUMPTION

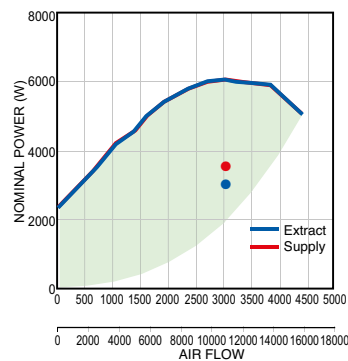

Note: Green area denotes power consumption range. Power consumption depends on system installation.
+ excludes motors. Motor warranty one year from date of purchase.

HEAT RECOVERY EFFICIENCY

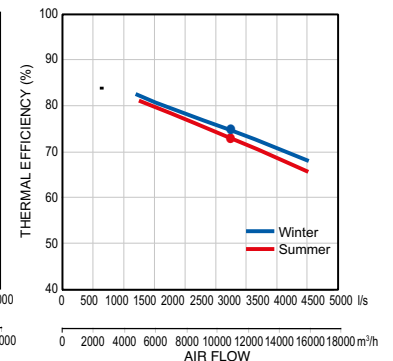

Sound Power Level L _w	Total	63 Hz	125 Hz	250 Hz	500 Hz	1 kHz	2 kHz	4 kHz	8 kHz
	dB (A)								
Outdoor air e1	75	57	66	71	70	66	62	53	44
Supply air e2	94	72	79	83	90	90	83	71	57
Extract air i1	75	57	66	71	70	65	60	51	42
Exhaust air i2	93	71	79	82	89	89	82	70	55
Breakout noise	68	44	59	60	61	62	62	57	42
Sound Pressure Level L _p measured at 3m	48	<25	39	40	41	42	42	36	<25

Note: The figures above have been measured at 11000 m³/h and 400 Pa. Please use the Duplexvent Selection Software to calculate measurements at other performance levels.

Winter Operation:

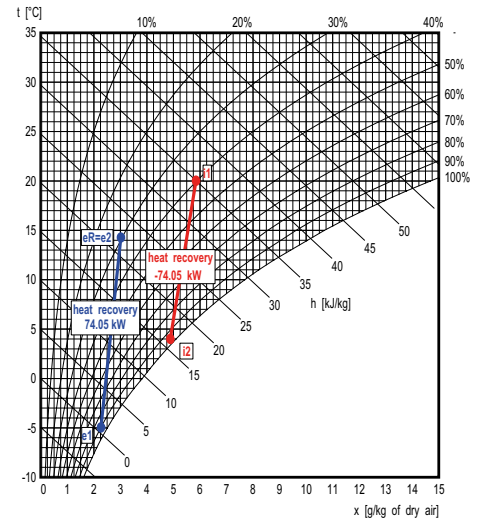
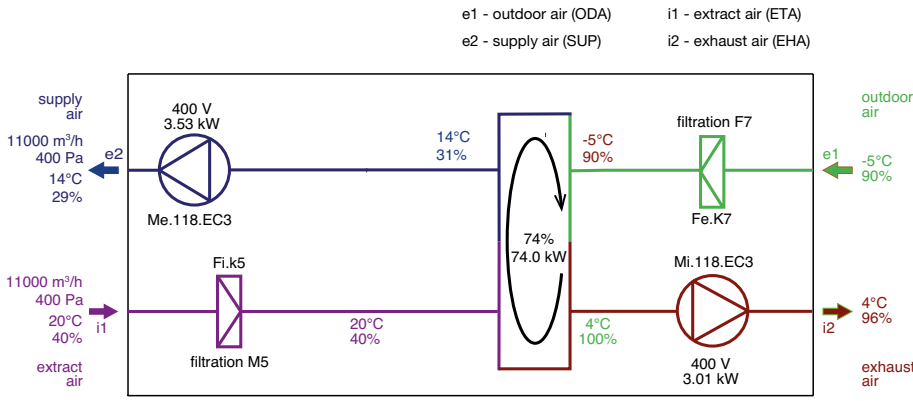

Supply

	Description	t [°C]	RH [%]
e1	Outdoor air	-5.0	90
e2	Supply air	14.3	29

Exhaust

	Description	t [°C]	RH [%]
i1	Extract Air	20.0	40
i2	Exhaust Air	4.2	96

Summer Operation:

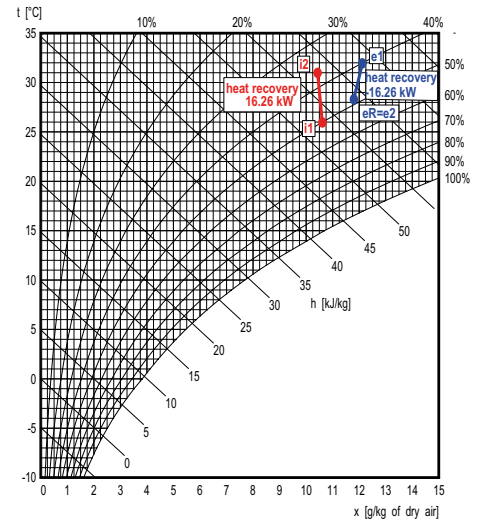
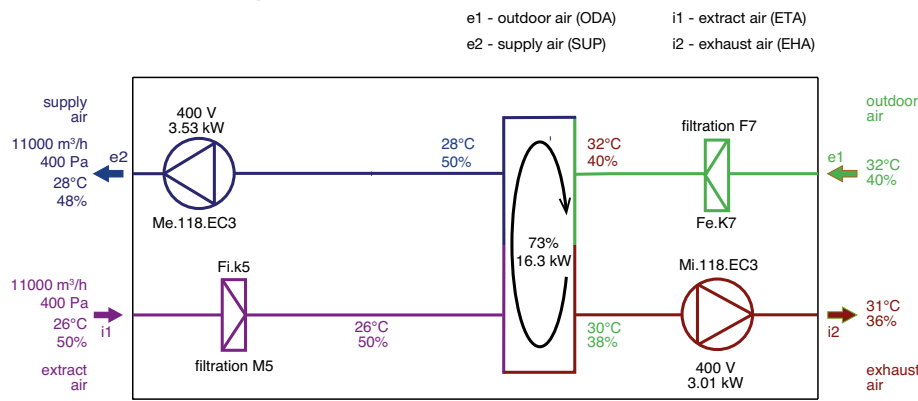

Supply

	Description	t [°C]	RH [%]
e1	Outdoor Air	32.0	40
e2	Supply Air	28.4	48

Exhaust

	Description	t [°C]	RH [%]
i1	Extract Air	26.0	50
i2	Exhaust Air	31.0	36

FILTERS

Filtration		Supply	Extract	Accessories (part of delivery)
Type		Pleated Cartridge		Pfe dirty filter pressure switch for supply air Pfi dirty filter pressure switch for extract air
Filtration class		ePM2,5 65 % (F7)	ePM10 70 % (M5)	
Number of filters	pcs	3	3	
Filter cartridge size	mm	900x533x96	900x533x96	

Duplexvent Rotary DV15000

Commercial MVHR with rotary thermal wheel - Indoor

OPTIONAL ACCESSORIES

ELECTRIC HEATER

Electric pre-heater		Supply
Air volume	m ³ /h / l/s	11000 / 3056
Maximum heating capacity	kW	54.0
Voltage	V	400
Connection ports	mm	500x800

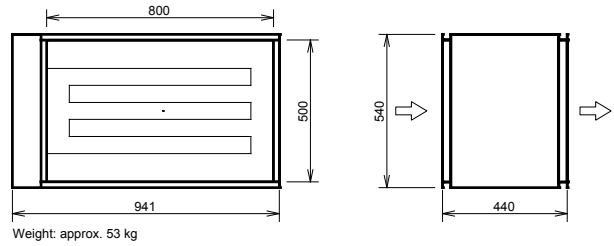

WATER HEATING COIL

Water heating coil		Supply
Heating medium		Water
Air volume	m ³ /h / l/s	11000 / 3056
Temperature at inlet (after heat recovery)	°C	14
Temperature at outlet (downstream of the heater)	°C	19
Heating capacity	kW	21.6
Heating medium temperature drop	°C	70 / 50
Medium flow (from source)	l/h	932
Connection dimension (hydraulic kit)		1" female

Note: The figures above have been measured at 11000 m³/h and 400 Pa. Please use the Duplexvent Selection Software to calculate measurements at other performance levels.

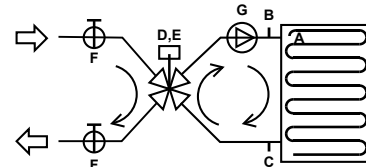

- A Freeze protection thermostat 016-H6929-109-6m
 - B Air vent automatic
 - C Sludge valve plug
 - Hydraulic kit: RE-TPO4. LM24A-SR
 - D Mixing valve IVAR.MIX4, Kv 12, 1"
 - E Actuator LM24A-SR
 - F Globe valve 1"
 - G Pump WILO YONOS PARA RS 20/6- RKC
- 1 - Delivered separately
2 - Fitted and connected

HEATING CAPACITY

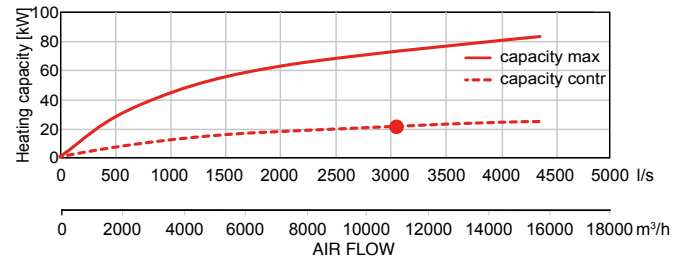

WATER COOLING COIL

Water cooling coil		Supply
Cooling medium		21% Ethylene glycol
Air volume	m ³ /h / l/s	11000 / 3056
Temperature at inlet (after heat recovery)	°C	28
Temperature at outlet (downstream of the cooling coil)	°C	16
Inlet relative humidity (after heat recovery)	% RH	50
Outlet relative humidity (downstream of the cooling coil)	% RH	85
Cooling capacity	kW	60.2
Condensate production	l/h	27
Water temperature drop	°C	6 / 12
Medium flow (at max. capacity)	l/h	9080
Medium-side pressure drop		
in heat exchanger	kPa	39.39
in valve	kPa	80.52
Connection dimension		1" female

Note: The figures above have been measured at 11000 m³/h and 400 Pa. Please use the Duplexvent Selection Software to calculate measurements at other performance levels.

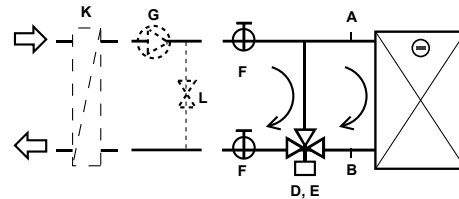

- A Air vent automatic
 - B Sludge valve plug
 - Hydraulic kit: R-CHW3.E.TR 24-SR
 - D 3-way ball valve R3020-B1
 - E Actuator TR 24-SR
 - F Globe valve 1"
 - Others:
 - G Pump
 - L Water bypass
 - K Coil water/ethylene glycol
- 1 - Delivered separately
2 - Fitted and connected
3 - Not part of delivery

COOLING CAPACITY

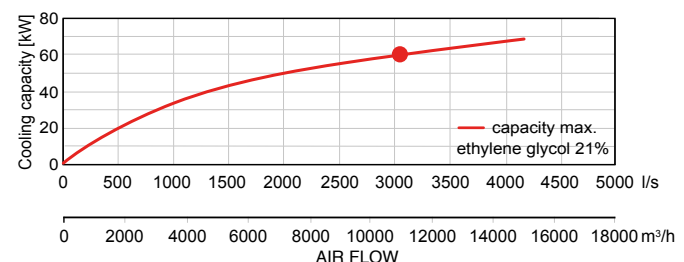

DX COIL

DX coil		Supply
Air volume	m ³ /h / l/s	11000 / 3056
Temperature at inlet (after heat recovery)	°C	28
Temperature at outlet (downstream of the DX coil)	°C	16
Inlet relative humidity (after heat recovery)	% RH	50
Outlet relative humidity (downstream of the DX coil)	% RH	78
Cooling capacity	kW	53.50
Condensate production	l/h	39
Refrigerant type		R410A
Evaporating temperature	°C	8

Note: The figures above have been measured at 11000 m³/h and 400 Pa. Please use the Duplexvent Selection Software to calculate measurements at other performance levels.

COOLING CAPACITY

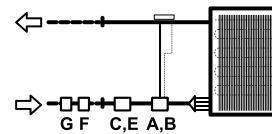
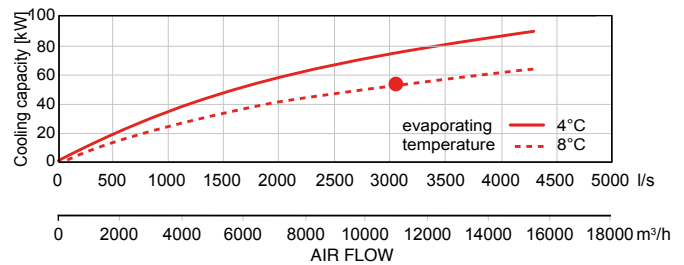

- A Expansion valve (3)
- B Nozzle (3)
- C Magnetic valve (3)
- E Coil ASC 230V/50-60 Hz (3)
- F Sight glass (3)
- G Drier (3)

3 Not part of delivery, recommended type mentioned

DIMENSIONS

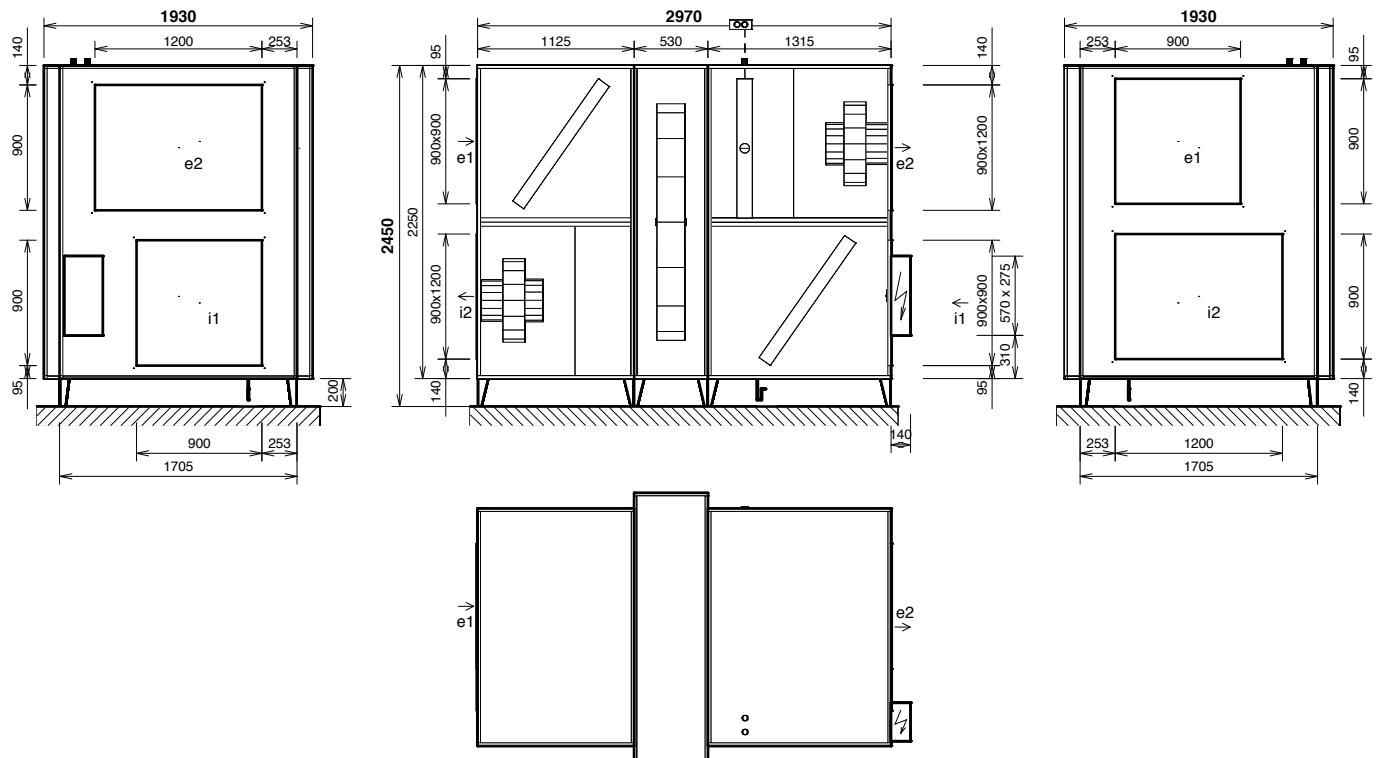

Connections	Type	Dimensions	Optional components
e1	e1- outdoor air (ODA)	900x900mm	Shutoff damper, Flexible connection
e2	e2- supply air (SUP)	900x1200mm	Flexible connection
i1	i1- extract air (ETA)	900x900mm	Shutoff damper, Flexible connection
i2	i2- exhaust air (EHA)	900x1200mm	Flexible connection
K	condensate drain	Ø 32 mm/40 mm	Condensate pump

Notice:

- Unit delivered in three parts
- Door is 3 parts
- Diagram is intended only for basic information, binding dimensions receive at device delivery, or on request from the manufacturer
- Bolt holes for duct connection (for one port): 4x M6

Duplexvent Rotary Roof

Commercial MVHR with rotary thermal wheel



KEY FEATURES

- Outdoor installation
- Equipped with hoods and roof for protection from the weather
- Customised units with a choice of duct orientations
- Highly efficient, certified by Eurovent rotary heat exchanger, up to 85% thermal efficiency
- Seven models available
- Excellent thermal insulation (class T2, TB1/TB2)
- Digital touchscreen or simple manual controller
- Integrated web server enables to control the unit via internet
- BMS connection (Modbus as a standard, optional BACnet or KNX)
- VAV control compatibility
- 2 year warranty+

Duplexvent Rotary Roof

The Duplexvent Rotary Roof is a range of all-purpose commercial MVHR units that are suitable for all commercial premises that require ventilation rate from 1400-11000 m³/h. The highly efficient rotary wheel heat exchanger recovers up to 85% of otherwise wasted heat to pre-warm the incoming supply air; reducing ongoing energy costs for the building. Rotary Roof units offer outstanding performance, with low SFP and high end

thermal insulation to minimise heat loss. You can control your Rotary Roof unit with ease thanks to a wide range of control options, which enables adjustment of the unit's ventilation with or without a BMS via an internet connected device such as smartphone, computer or Duplexvent digital controller.

+ Excludes motors. Motor warranty one year from date of purchase



CONTROL SYSTEM

BMS control interface is standard with Modbus TCP, (KNX and BACnet optional) protocols.

Alternatively the Duplexvent Web control system with internet connectivity may be specified to control remote equipment from a PC, Tablet or Smart phone





A NEW GENERATION IN MECHANICAL VENTILATION WITH HEAT RECOVERY

Duplexvent Rotary Roof units provide outstanding performance within a compact shape. The system comprises of separate supply and extract backward curved EC fans. Duplexvent Rotary Roof units are easy to transport and install on site and provide excellent MVHR performance for a range of commercial and industrial applications.

The casing is twin construction with high insulation and excellent thermal conductivity coefficient of 0.037 W/mK . It is rated to Thermal insulation class T2 and thermal bridging class

TB1/TB2 (depending on the unit). Access doors are provided for ease of filter maintenance. Thanks to the highly efficient EC motors, Rotary Roof units achieve extremely low SFP values from $0.45 \text{ W/(m}^3/\text{h)}$. Rotary Roof units are designed to be installed outdoors. Thanks to the steel hood found on all units which cover the supply air inlet and the extract air inlet, the Duplexvent Rotary Roof is protected against the weather. This protection helps to extend the life of the unit and maintain its long term optimal performance.



Duplexvent Rotary Roof

Commercial MVHR with rotary thermal wheel

TECHNICAL DATA

OPERATING MODES

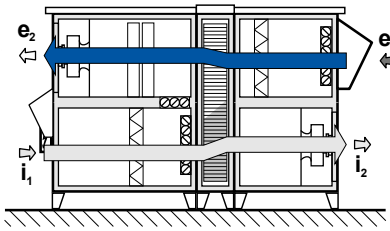

Heat recovery mode with re-heating and cooling

→ e₁ ...Outdoor air (ODA)
 ↪ e₂ ...Supply air (SUP)

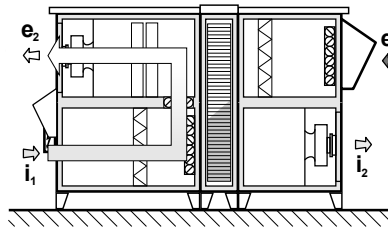

Recirculation mode with heating and cooling

↪ i₁ ...Extract air (ETA)
 ↪ i₂ ...Exhaust air (EHA)

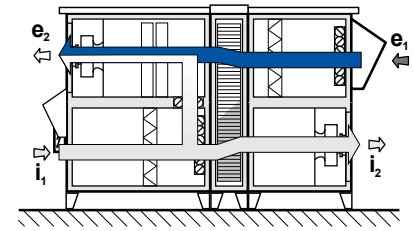

Combined mode (heat recovery mode with recirculation)

T ...Central heating connection
 CH ...Cooling connection

Duplexvent Rotary Roof		DV1500	DV2500	DV4000	DV5000	DV8000	DV12000	DV15000
Maximum air flow according to ErP 2018	m ³ /h / l/s	1400/389	2400/667	4000/1111	4800/1333	7150/1986	9400/2611	11000/3056
Reference external static pressure	Pa	200	200	200	200	400	400	400
Heat recovery efficiency	%	see curve						
Fan type		EC (backward curved impeller)						
Weight ¹	kg	355-400	360-405	570-640	575-645	850-1060	1140-1360	1340-1610
Max power input	kW	0.8	1.7	2.9	5.1	9.9	10.2	11.3
Voltage	V	230		400	400	400	400	400
Frequency		50						
Fan speed	min ⁻¹	3350	2960	3000	2980	2570	2130	1860
Heating output T - max. ²	kW	17	22	42	50	70	100	120
Cooling output CHW - max. ²	kW	10	18	35	39	50	61	80
Cooling output CHF - max. ²	kW	17	24	36	40	47	60	85
Part Number		90000728	90000729	90000730	90000731	90000571	90000572	90000573

1. Depending on equipment
2. Depending on flow rate, external air temperature, medium type

T - Water heating coil
 CHW - Water cooling coil
 CHF - DX (direct expansion) coil

PERFORMANCE

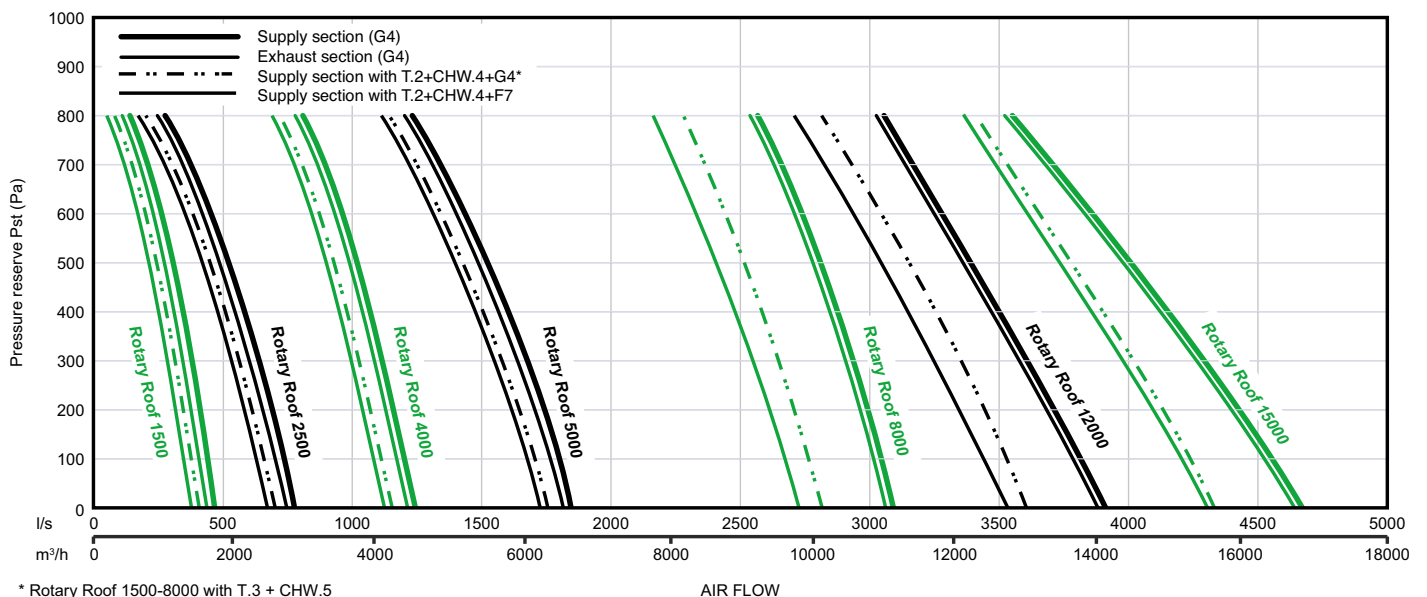

HEATING AND COOLING CAPACITY

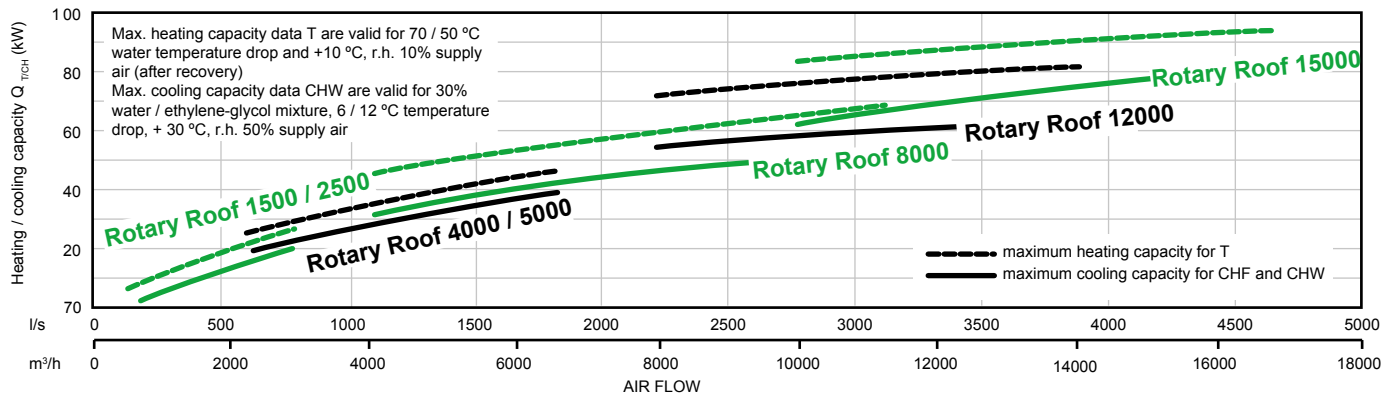

HEAT RECOVERY EFFICIENCY

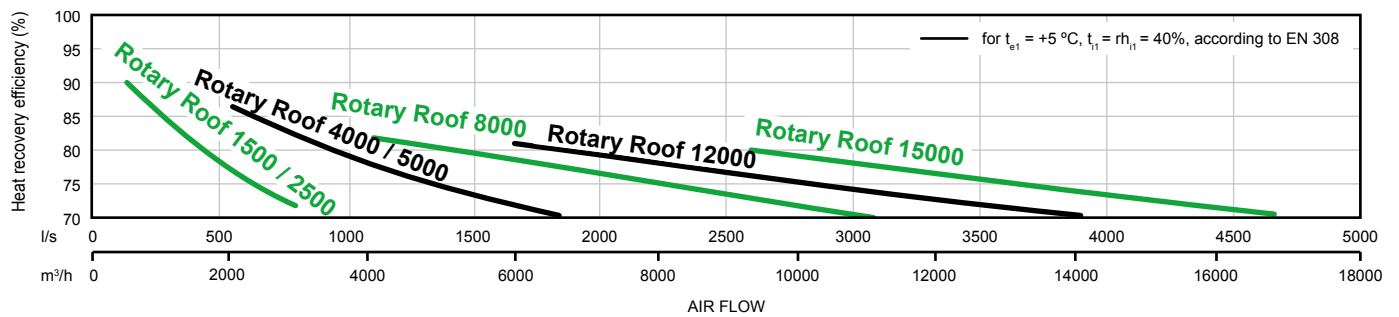

CONNECTION PORTS

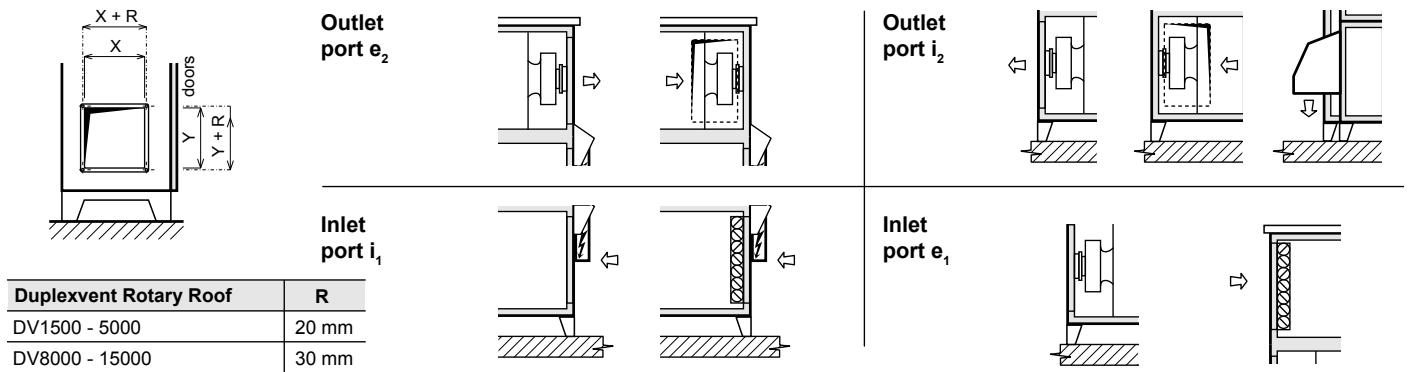

Note: For detailed information we recommend using Duplexvent selection software available at airflow.com

Duplexvent Rotary Roof

Commercial MVHR with rotary thermal wheel

INSTALLATION CONFIGURATION

DUPLEXVENT ROTARY ROOF INSTALLATION POSITIONS AND PORT CONFIGURATIONS

The Duplexvent Rotary Roof range is available in a number of different configurations. This connection versatility enables the Duplexvent Rotary Roof units to be installed in cramped spaces.

For a detailed unit design we recommend a Duplexvent selection software to be used; available at www.airflow.com

All Duplexvent Rotary Roof units are available with a wide range of accessories. For example, the ports can be fitted with flexible flanges and shut-off dampers if required.

ROOFTOP

1500 - 15000 Rotary Roof

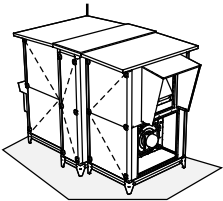

configuration 60/x - door-side view (up to 4 configurations in total)

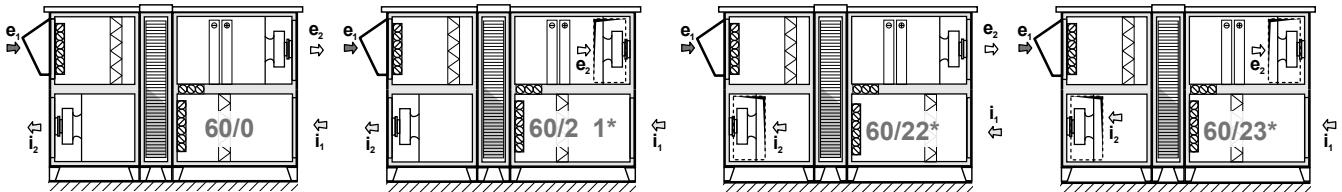

configuration 61/x - door-side view (up to 4 configurations in total)

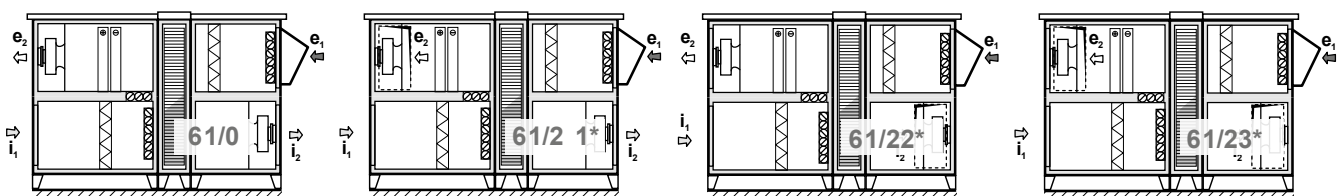

* Only for Duplexvent Rotary Roof DV8000-DV15000

MANIPULATION SPACE

DUPLEXVENT ROTARY ROOF MANIPULATION SPACE

Duplexvent Rotary Roof units must be installed with the unit's handling space (outlined below) in mind.

There must be a 150 mm gap underneath the unit to install the condensate drain system, as the system must run through a U-bend at least 150 mm high into the sewer. This space is easily achieved when the supporting feet, which are supplied as standard, are used when the unit is installed. The handling

space in front of the unit must be maintained so the unit can be serviced.

In addition the handling spaces outlined below, there must be a minimum 600 mm space from the side of electric switchboard of the control system.

Units fitted with additional heaters or coolers must have free space from the side of the manifold.

MANIPULATION SPACE, UNIT CONFIGURATION

Floor standing horizontal

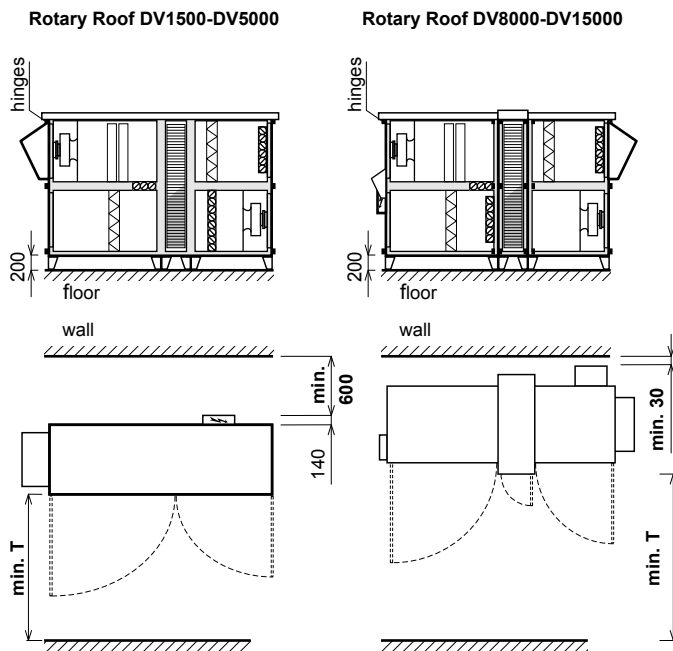

MANIPULATION SPACE FOR UNIT ACCESSORIES

Control manifolds

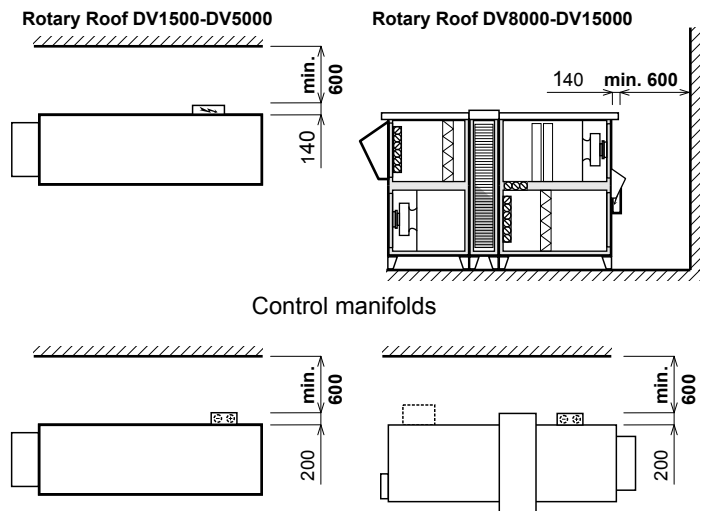

Control manifolds

Duplexvent Rotary Roof	Standard door T [mm]
DV1500	900
DV2500	900
DV4000	1200
DV5000	1200
DV8000	1600
DV12000	1800
DV15000	2000

Duplexvent Rotary Roof DV1500

Commercial MVHR
with rotary thermal wheel - Outdoor



PERFORMANCE

Ventilation		Supply Air	Extract Air
Air volume @ 200 Pa	m ³ /h / l/s	1000 / 278	1000 / 278
Nominal voltage	V	230	230
Nominal power (at operation point)	kW	0.1	0.1
Fan Speed	min ⁻¹	2709	2627
Max power input	kW	0.4	0.4
Max current	A	2.5	2.5
Fan Type		EC	EC

Note: The figures above have been measured at 1000 m³/h and 200 Pa. Please use the Duplexvent Selection Software to calculate measurements at other performance levels.

Heat Recovery		Supply Air	Extract Air
Air volume @ 200 Pa	m ³ /h / l/s	1000 / 278	1000 / 278
Temperature at inlet	°C	-5	20
Temperature at outlet	°C	17	0
Humidity at inlet	% RH	90	40
Humidity at outlet	% RH	33	95
Heat recovery efficiency winter/summer	%	86 / 87	
Humidity recovery efficiency winter/summer	%	46 / 0	
Total heat gain winter/summer	kW	8.6 / 1.8	
Sensible heat gain winter/summer	kW	6.8 / 2	
Latent heat gain winter/summer	kW	1.9 / 0	
Heat exchanger speed	RPM	10-13	
Type of heat exchanger		Thermal Rotary Wheel	
Part No.		90000728	

Note: The figures above have been measured at 1000 m³/h and 200 Pa. Please use the Duplexvent Selection Software to calculate measurements at other performance levels.

Sound Power Level L _w	Total	63 Hz	125 Hz	250 Hz	500 Hz	1 kHz	2 kHz	4 kHz	8 kHz
	dB (A)								
Outdoor air e1	59	<25	34	51	53	54	53	48	44
Supply air e2	77	42	48	55	64	71	74	68	70
Extract air i1	59	32	39	50	51	52	53	51	42
Exhaust air i2	77	40	48	54	63	69	72	70	69
Breakout noise	53	46	37	47	44	47	43	37	29
Sound Pressure Level L _p measured at 3m at inlet e1	39	<25	<25	30	32	33	32	27	<25
Sound Pressure Level L _p measured at 3m	32	25	<25	26	<25	27	<25	<25	<25

Note: The figures above have been measured at 1000 m³/h and 200 Pa. Please use the Duplexvent Selection Software to calculate measurements at other performance levels.

KEY FEATURES

- Air volume up to 1400 m³/h at 200 Pa according to ErP 2018
- Weather protection hoods and a roof
- Highly efficient, certified by Eurovent rotary heat exchanger, up to 85% thermal efficiency
- Low SFP and energy saving EC fans
- Digital touchscreen or manual controller or BMS
- VAV control compatibility
- Filters: ePM2,5 65 % (F7), ePM10 70 % (M5) or Coarse 60 % (G4)
- Optional equipment: recirculation damper, heating or cooling coils, purge chamber
- Optional constant flow / pressure mode
- 2 year warranty+

AIR FLOW CURVE

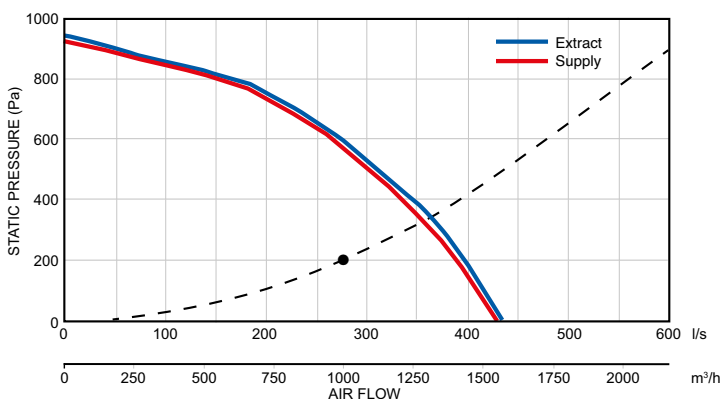

POWER CONSUMPTION

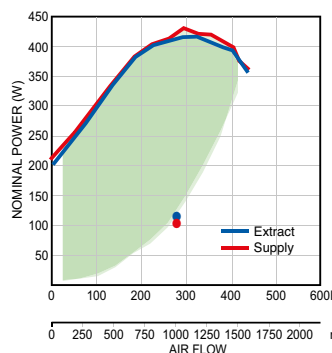

Note: Green area denotes power consumption range. Power consumption depends on system installation.
+ excludes motors. Motor warranty one year from date of purchase.

HEAT RECOVERY EFFICIENCY

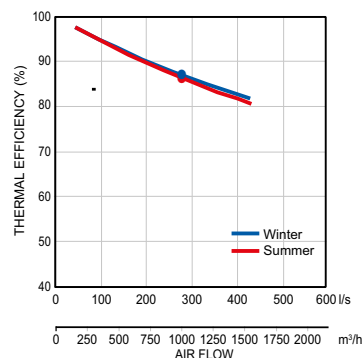

Winter Operation:

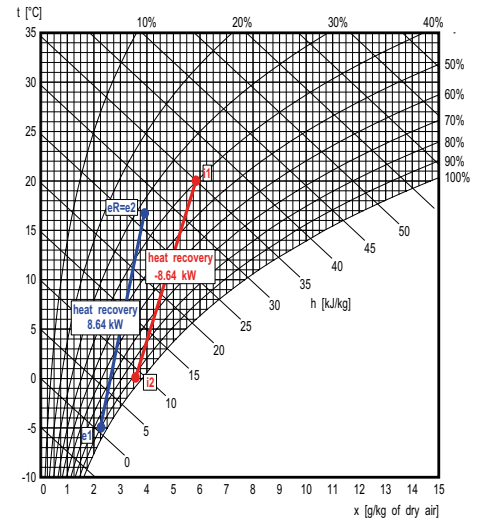
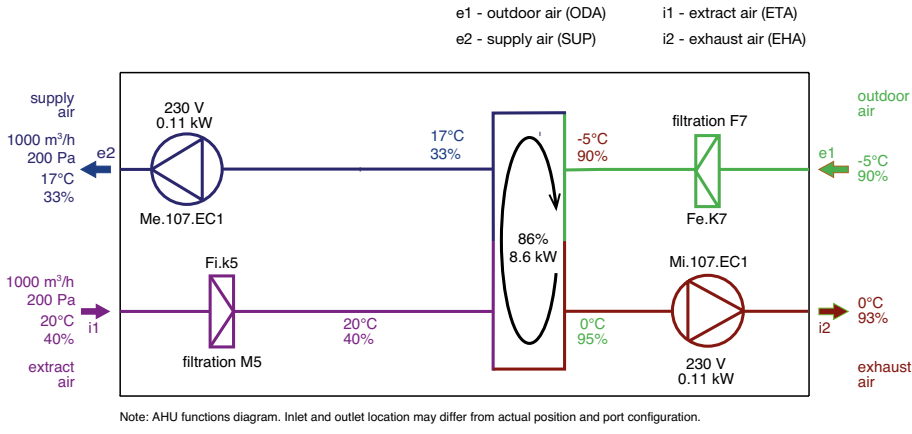

Supply

Description	t [°C]	RH [%]
e1 Outdoor air	-5.0	90
e2 Supply air	16.8	33

Exhaust

Description	t [°C]	RH [%]
i1 Extract Air	20.0	40
i2 Exhaust Air	0.1	93

Summer Operation:

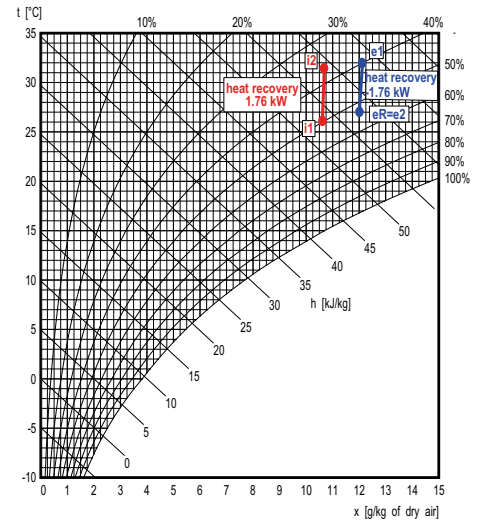
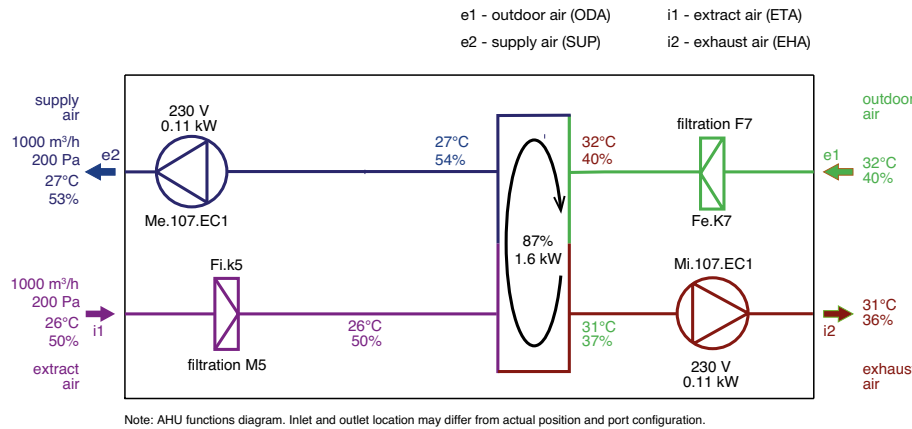

Supply

Description	t [°C]	RH [%]
e1 Outdoor Air	32.0	40
e2 Supply Air	27.0	53

Exhaust

Description	t [°C]	RH [%]
i1 Extract Air	26.0	50
i2 Exhaust Air	31.5	36

FILTERS

Filtration	Supply	Extract	Accessories (part of delivery)
Type	Pleated Cartridge		Pfe dirty filter pressure switch for supply air Pfi dirty filter pressure switch for extract air
Filtration class	ePM2,5 65 % (F7)	ePM10 70 % (M5)	
Number of filters	pcs 1	1	
Filter cartridge size	mm 750x495x96	750x495x96	

Duplexvent Rotary Roof DV1500

Commercial MVHR
with rotary thermal wheel - Outdoor

OPTIONAL ACCESSORIES

ELECTRIC HEATER

Electric pre-heater		Supply
Air volume	m ³ /h / l/s	1000 / 278
Maximum heating capacity	kW	6.0
Voltage	V	400
Connection ports	mm	250x500

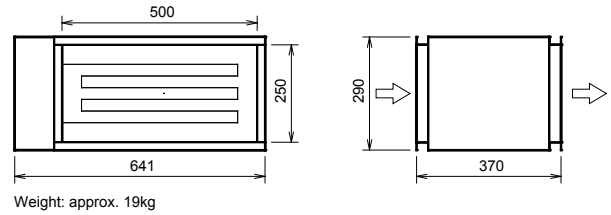

WATER HEATING COIL

Water heating coil		Supply
Heating medium		21% Ethylene glycol
Air volume	m ³ /h / l/s	1000 / 278
Temperature at inlet (after heat recovery)	°C	15
Temperature at outlet (downstream of the heater)	°C	20
Heating capacity	kW	1.5
Heating medium temperature drop	°C	70 / 50
Medium flow (from source)	l/h	64
Connection dimension (hydraulic kit)		5/4" female

Note: The figures above have been measured at 1000 m³/h and 200 Pa. Please use the Duplexvent Selection Software to calculate measurements at other performance levels.

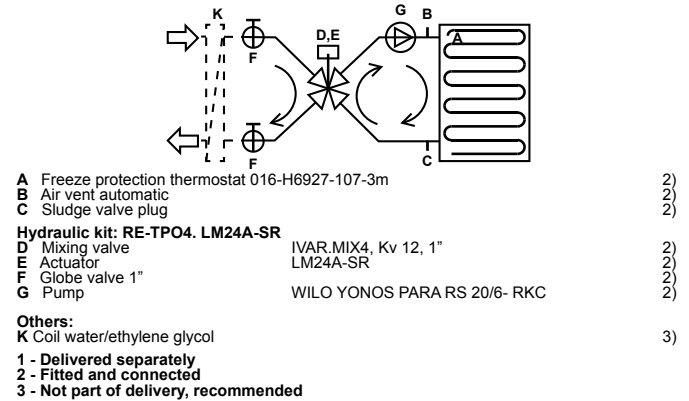

HEATING CAPACITY

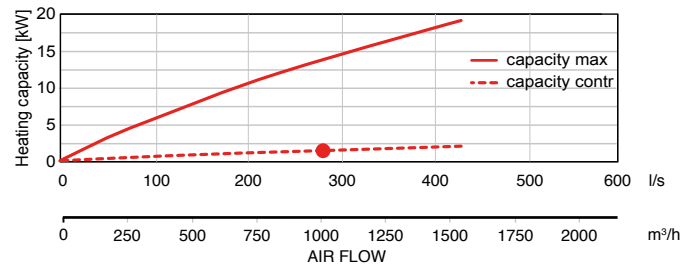

WATER COOLING COIL

Water cooling coil		Supply
Cooling medium		21% Ethylene glycol
Air volume	m ³ /h / l/s	1000 / 278
Temperature at inlet (after heat recovery)	°C	27
Temperature at outlet (downstream of the cooling coil)	°C	17
Inlet relative humidity (after heat recovery)	% RH	54
Outlet relative humidity (downstream of the cooling coil)	% RH	85
Cooling capacity	kW	4.9
Condensate production	l/h	2
Water temperature drop	°C	6 / 12
Medium flow (at max. capacity)	l/h	950
Medium-side pressure drop		
in heat exchanger	kPa	3.95
in valve	kPa	0.89
Connection dimension		5/4" female

Note: The figures above have been measured at 1000 m³/h and 200 Pa. Please use the Duplexvent Selection Software to calculate measurements at other performance levels.

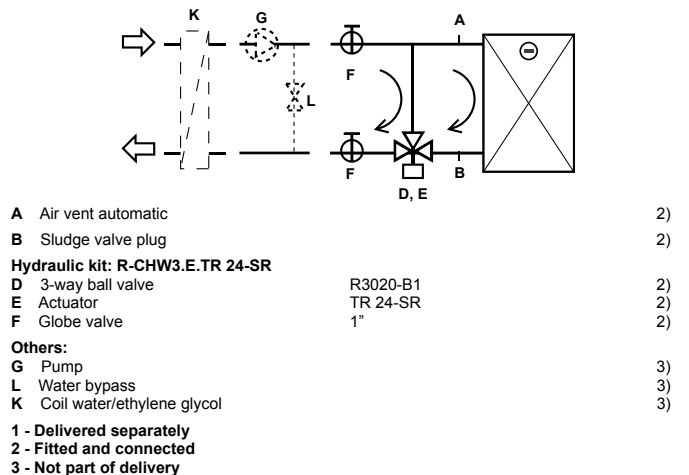

COOLING CAPACITY

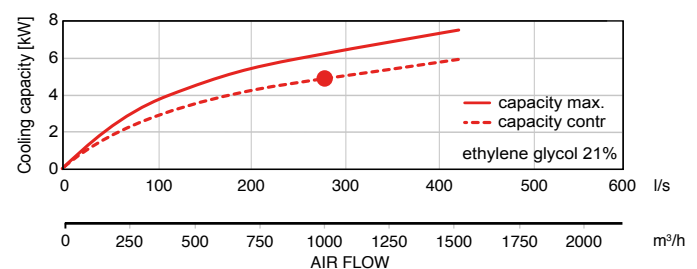

DX COIL

DX coil		Supply
Air volume	m ³ /h / l/s	1000 / 278
Temperature at inlet (after heat recovery)	°C	27
Temperature at outlet (downstream of the DX coil)	°C	17
Inlet relative humidity (after heat recovery)	% RH	54
Outlet relative humidity (downstream of the DX coil)	% RH	77
Cooling capacity	kW	5.30
Condensate production	l/h	4
Refrigerant type		R410A
Evaporating temperature	°C	5

Note: The figures above have been measured at 1000 m³/h and 200 Pa. Please use the Duplexvent Selection Software to calculate measurements at other performance levels.

COOLING CAPACITY

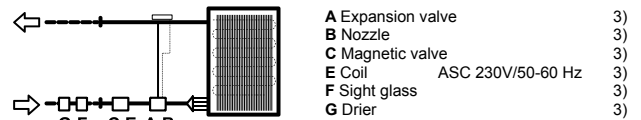
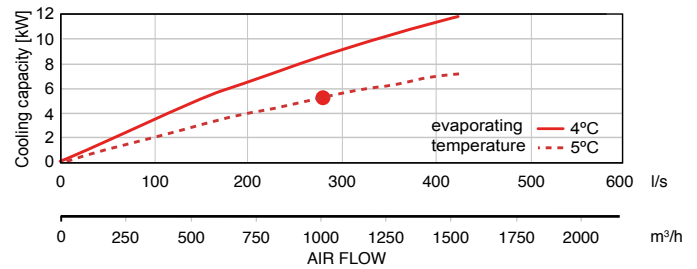

3 Not part of delivery, recommended type mentioned

DIMENSIONS

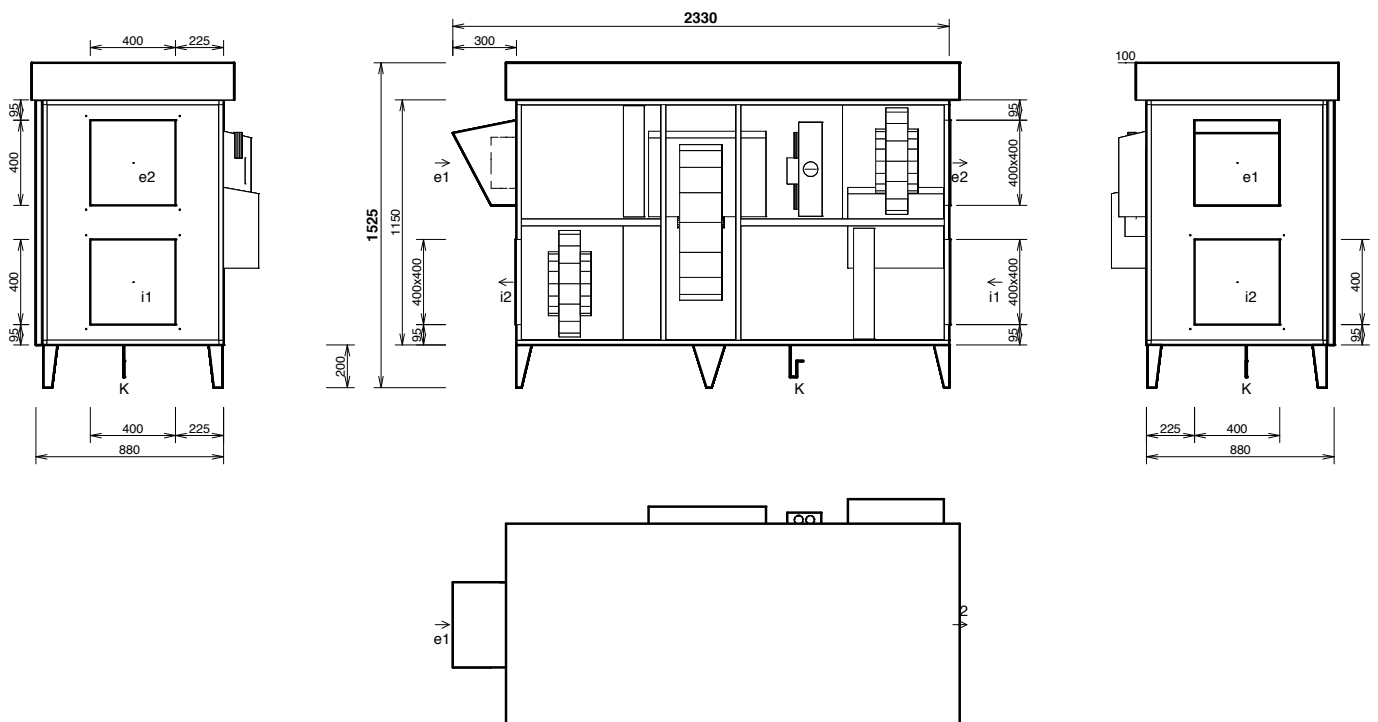

Connections	Type	Dimensions	Optional accessories
e1	e1- outdoor air (ODA)		Shutoff damper
e2	e2- supply air (SUP)	400x400mm	Flexible connection
i1	i1- extract air (ETA)	400x400mm	Shutoff damper, Flexible connection
i2	i2- exhaust air (EHA)	400x400mm	Flexible connection
K	condensate drain	Ø 32 mm/40 mm	Condensate pump

Notice:

- Diagram is intended only for basic information, binding dimensions receive at device delivery, or on request from the manufacturer

- Bolt holes for duct connection (for one port): 4x M6

- Including base frame heights 200mm

Duplexvent Rotary Roof DV2500

Commercial MVHR
with rotary thermal wheel - Outdoor



PERFORMANCE

Ventilation		Supply Air	Extract Air
Air volume @ 200 Pa	m ³ /h / l/s	2000 / 556	2000 / 556
Nominal voltage	V	230	230
Nominal power (at operation point)	kW	0.4	0.4
Fan Speed	min ⁻¹	2547	2508
Max power input	kW	0.8	0.8
Max current	A	3.9	3.9
Fan Type		EC	EC

Note: The figures above have been measured at 2000 m³/h and 200 Pa. Please use the Duplexvent Selection Software to calculate measurements at other performance levels.

Heat Recovery		Supply Air	Extract Air
Air volume @ 200 Pa	m ³ /h / l/s	-5	20
Temperature at inlet	°C	14	2
Temperature at outlet	°C	90	40
Humidity at inlet	% RH	37	95
Humidity at outlet	% RH	33	95
Heat recovery efficiency winter/summer	%	77 / 78	
Humidity recovery efficiency winter/summer	%	41 / 0	
Total heat gain winter/summer	kW	15.4 / 3.2	
Sensible heat gain winter/summer	kW	12.5 / 3.0	
Latent heat gain winter/summer	kW	3.0 / 0	
Heat exchanger speed	RPM	10-13	
Type of heat exchanger		Thermal Rotary Wheel	
Part No.		90000729	

Note: The figures above have been measured at 2000 m³/h and 200 Pa. Please use the Duplexvent Selection Software to calculate measurements at other performance levels.

Sound Power Level L _w	Total	63 Hz	125 Hz	250 Hz	500 Hz	1 kHz	2 kHz	4 kHz	8 kHz
	dB (A)								
Outdoor air e1	67	29	40	63	64	56	52	46	40
Supply air e2	80	52	67	75	76	74	71	65	59
Extract air i1	67	38	45	64	63	56	51	45	39
Exhaust air i2	80	51	66	74	75	73	70	65	58
Breakout noise	59	47	41	57	52	49	37	32	<25
Sound Pressure Level L _p measured at 3m at inlet e1	46	<25	<25	42	43	36	31	26	<25
Sound Pressure Level L _p measured at 3m	38	26	<25	36	31	28	<25	<25	<25

Note: The figures above have been measured at 2000 m³/h and 200 Pa. Please use the Duplexvent Selection Software to calculate measurements at other performance levels.

KEY FEATURES

- Air volume up to 2000 m³/h at 200 Pa according to ErP 2018
- Weather protection hoods and a roof
- Highly efficient, certified by Eurovent rotary heat exchanger, up to 85% thermal efficiency
- Low SFP and energy saving EC fans
- Digital touchscreen or manual controller or BMS
- VAV control compatibility
- Filters: ePM2,5 65 % (F7), ePM10 70 % (M5) or Coarse 60 % (G4)
- Optional equipment: recirculation damper, heating or cooling coils, purge chamber
- Optional constant flow / pressure mode
- 2 year warranty+

AIR FLOW CURVE

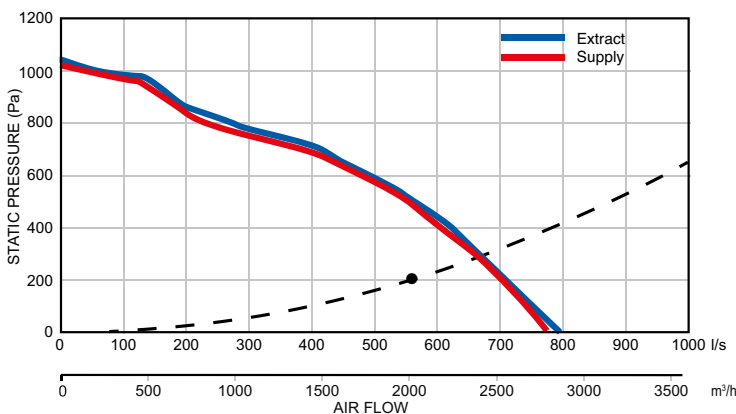

POWER CONSUMPTION

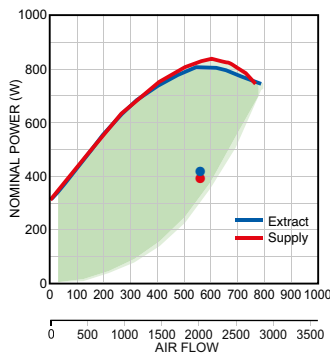

Note: Green area denotes power consumption range. Power consumption depends on system installation.
+ excludes motors. Motor warranty one year from date of purchase.

HEAT RECOVERY EFFICIENCY

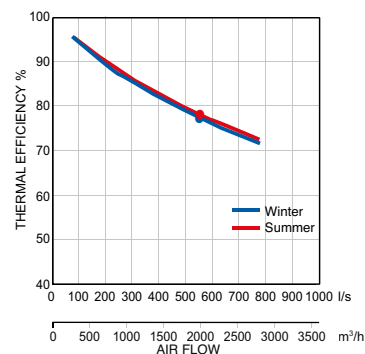

Winter Operation:

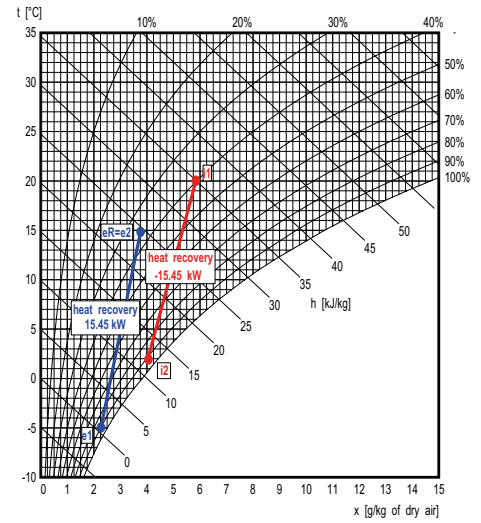
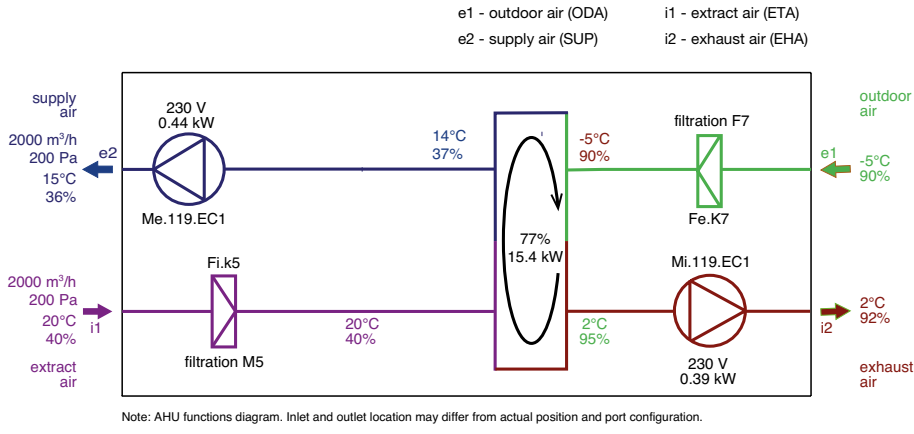

Supply

Description	t [°C]	RH [%]
e1 Outdoor air	-5.0	90
e2 Supply air	14.8	33

Exhaust

Description	t [°C]	RH [%]
i1 Extract air	20.0	40
i2 Exhaust air	1.9	93

Summer Operation:

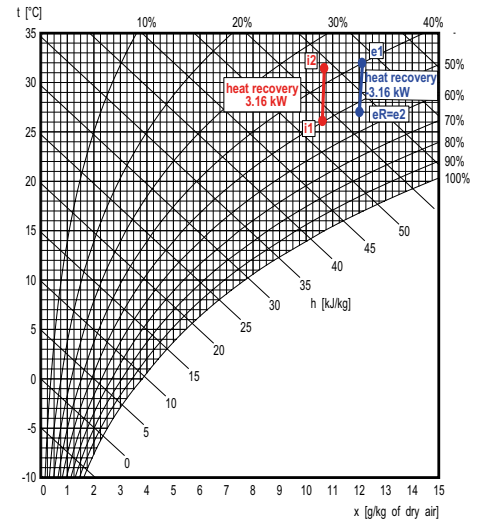
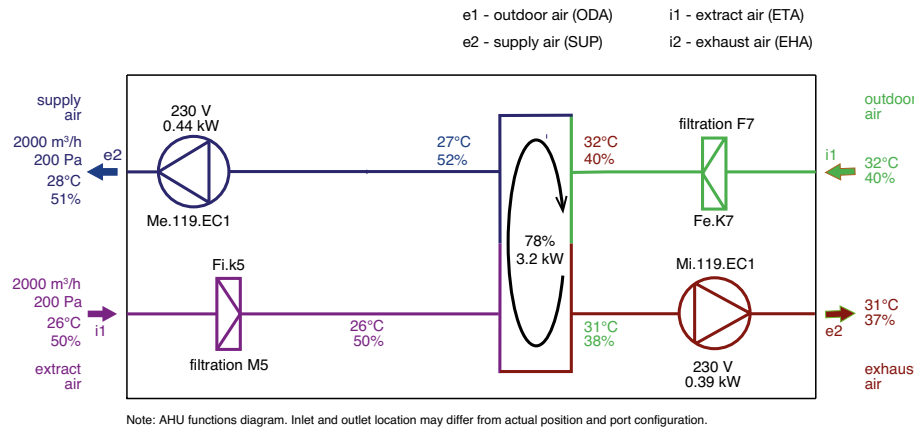

Supply

Description	t [°C]	RH [%]
e1 Outdoor air	32.0	40
e2 Supply air	27.8	51

Exhaust

Description	t [°C]	RH [%]
i1 Extract air	26.0	50
i2 Exhaust air	31.1	37

FILTERS

Filtration	Supply	Extract	Accessories (part of delivery)
Type	Pleated Cartridge		Pfe dirty filter pressure switch for supply air Pfi dirty filter pressure switch for extract air
Filtration class	ePM2,5 65 % (F7)	ePM10 70 % (M5)	
Number of filters	pcs 1	1	
Filter cartridge size	mm 750x495x96	750x495x96	

Duplexvent Rotary Roof DV2500

Commercial MVHR
with rotary thermal wheel - Outdoor

OPTIONAL ACCESSORIES

ELECTRIC HEATER

Electric pre-heater		Supply
Air volume	m ³ /h / l/s	2000 / 556
Maximum heating capacity	kW	6.0
Voltage	V	400
Connection ports	mm	250x500

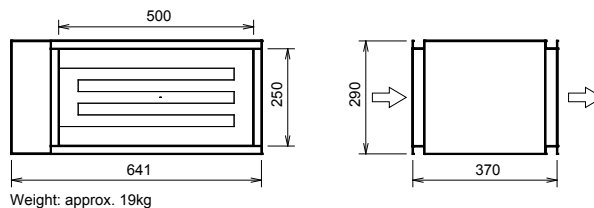

WATER HEATING COIL

Water heating coil		Supply
Heating medium		21% Ethylene glycol
Air volume	m ³ /h / l/s	2000 / 556
Temperature at inlet (after heat recovery)	°C	14
Temperature at outlet (downstream of the heater)	°C	19
Heating capacity	kW	3.6
Heating medium temperature drop	°C	70 / 50
Medium flow (from source)	l/h	155
Connection dimension (hydraulic kit)		5/4" female

Note: The figures above have been measured at 2000 m³/h and 200 Pa. Please use the Duplexvent Selection Software to calculate measurements at other performance levels.

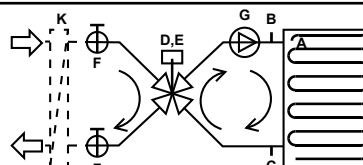

- A Freeze protection thermostat 016-H6927-107-3m
 - B Air vent automatic
 - C Sludge valve plug
 - Hydraulic kit: RE-TPO4. LM24A-SR**
 - D Mixing valve
 - E Actuator
 - F Globe valve 1"
 - G Pump
- Others:
- K Coil water/ethylene glycol
- 1 - Delivered separately
2 - Fitted and connected
3 - Not part of delivery, recommended

HEATING CAPACITY

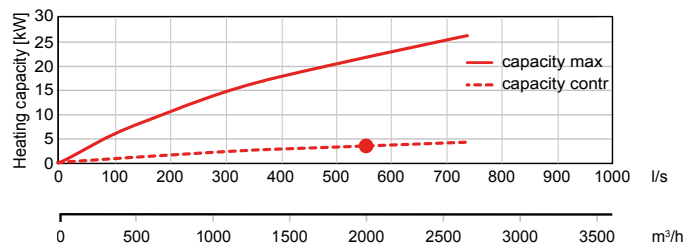

WATER COOLING COIL

Water cooling coil		Supply
Cooling medium		21% Ethylene glycol
Air volume	m ³ /h / l/s	2000 / 278
Temperature at inlet (after heat recovery)	°C	27
Temperature at outlet (downstream of the cooling coil)	°C	16
Inlet relative humidity (after heat recovery)	% RH	52
Outlet relative humidity (downstream of the cooling coil)	% RH	94
Cooling capacity	kW	8.9
Condensate production	l/h	2
Water temperature drop	°C	6 / 12
Medium flow (at max. capacity)	l/h	1350
Medium-side pressure drop		
in heat exchanger	kPa	5.23
in valve	kPa	1.8
Connection dimension		5/4" female

Note: The figures above have been measured at 2000 m³/h and 200 Pa. Please use the Duplexvent Selection Software to calculate measurements at other performance levels.

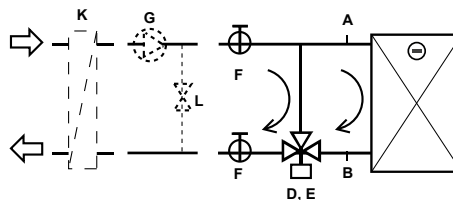

- A Air vent automatic
 - B Sludge valve plug
 - Hydraulic kit: R-CHW3.E.TR 24-SR**
 - D 3-way ball valve
 - E Actuator
 - F Globe valve
 - G Pump
 - L Water bypass
 - K Coil water/ethylene glycol
- Others:
- G Pump
 - L Water bypass
 - K Coil water/ethylene glycol
- 1 - Delivered separately
2 - Fitted and connected
3 - Not part of delivery

COOLING CAPACITY

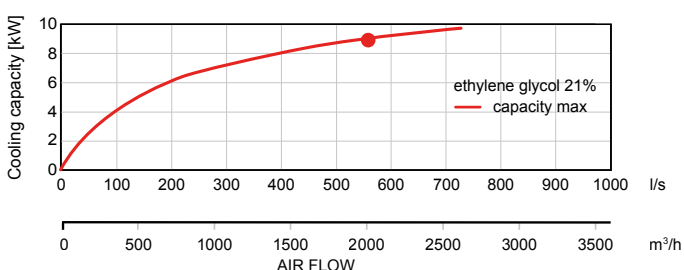

DX COIL

DX coil		Supply
Air volume	m ³ /h / l/s	2000 / 556
Temperature at inlet (after heat recovery)	°C	27
Temperature at outlet (downstream of the DX coil)	°C	16
Inlet relative humidity (after heat recovery)	% RH	52
Outlet relative humidity (downstream of the DX coil)	% RH	77
Cooling capacity	kW	9.35
Condensate production	l/h	7
Refrigerant type		R410A
Evaporating temperature	°C	10

Note: The figures above have been measured at 2000 m³/h and 200 Pa. Please use the Duplexvent Selection Software to calculate measurements at other performance levels.

COOLING CAPACITY

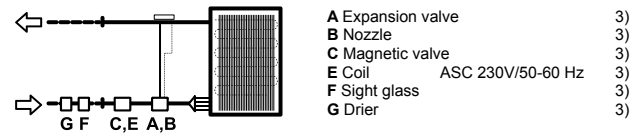
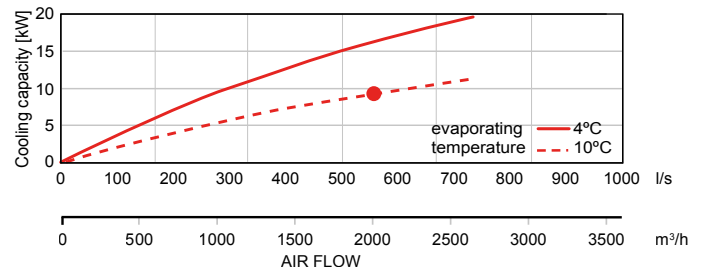

3 Not part of delivery, recommended type mentioned

DIMENSIONS

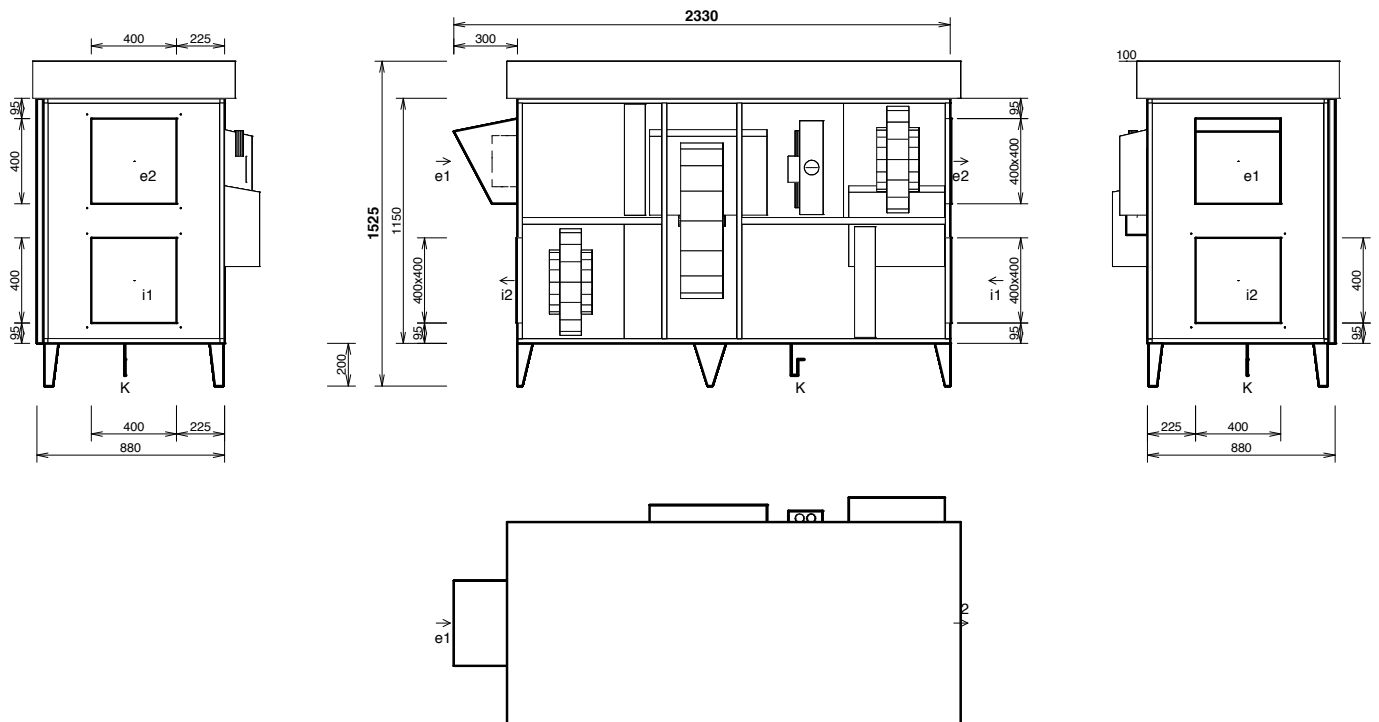

Connections	Type	Dimensions	Optional accessories
e1	e1- outdoor air (ODA)		Shutoff damper
e2	e2- supply air (SUP)	400x400mm	Flexible connection
i1	i1- extract air (ETA)	400x400mm	Shutoff damper, Flexible connection
i2	i2- exhaust air (EHA)	400x400mm	Flexible connection
K	condensate drain	Ø 32 mm/40 mm	Condensate pump

Notice:

- Diagram is intended only for basic information, binding dimensions receive at device delivery, or on request from the manufacturer

- Bolt holes for duct connection (for one port): 4x M6

- Including base frame heights 200mm

Duplexvent Rotary Roof DV4000

Commercial MVHR
with rotary thermal wheel - Outdoor



PERFORMANCE

Ventilation		Supply Air	Extract Air
Air volume @ 200 Pa	m ³ /h / l/s	3000 / 833	3000 / 833
Nominal voltage	V	400	400
Nominal power (at operation point)	kW	0.7	0.6
Fan Speed	min ⁻¹	2410	2375
Max power input	kW	2.5	2.5
Max current	A	4	4
Fan Type		EC	EC

Note: The figures above have been measured at 3000 m³/h and 200 Pa. Please use the Duplexvent Selection Software to calculate measurements at other performance levels.

Heat Recovery		Supply Air	Extract Air
Air volume @ 200 Pa	m ³ /h / l/s	3000 / 833	3000 / 833
Temperature at inlet	°C	-5	20
Temperature at outlet	°C	15	1
Humidity at inlet	% RH	90	40
Humidity at outlet	% RH	35	95
Heat recovery efficiency winter/summer	%	81 / 82	
Humidity recovery efficiency winter/summer	%	43 / 0	
Total heat gain winter/summer	%	24.3 / 5.0	
Sensible heat gain winter/summer	kW	19.4 / 5.0	
Latent heat gain winter/summer	kW	4.9 / 0	
Heat exchanger speed	RPM	10-13	
Type of heat exchanger		Thermal Rotary Wheel	
Part No.		90000730	

Note: The figures above have been measured at 3000 m³/h and 200 Pa. Please use the Duplexvent Selection Software to calculate measurements at other performance levels.

Sound Power Level L _w	Total	63 Hz	125 Hz	250 Hz	500 Hz	1 kHz	2 kHz	4 kHz	8 kHz
Outdoor air e1	66	30	42	60	63	59	57	52	49
Supply air e2	84	52	63	76	80	79	75	69	62
Extract air i1	67	36	44	61	63	59	57	52	49
Exhaust air i2	84	52	63	76	80	79	75	69	62
Breakout noise	65	48	46	54	64	56	42	46	29
Sound Pressure Level L _p measured at 3m at inlet e1	46	<25	<25	40	42	38	37	31	<28
Sound Pressure Level L _p measured at 3m	45	27	26	34	43	35	<25	26	<25

Note: The figures above have been measured at 3000 m³/h and 200 Pa. Please use the Duplexvent Selection Software to calculate measurements at other performance levels.

KEY FEATURES

- Air volume up to 3000 m³/h at 200 Pa according to ErP 2018
- Weather protection hoods and a roof
- Highly efficient, certified by Eurovent rotary heat exchanger, up to 85% thermal efficiency
- Low SFP and energy saving EC fans
- Digital touchscreen or manual controller or BMS
- VAV control compatibility
- Filters: ePM2,5 65 % (F7), ePM10 70 % (M5) or Coarse 60 % (G4)
- Optional equipment: recirculation damper, heating or cooling coils, purge chamber
- Optional constant flow / pressure mode
- 2 year warranty+

AIR FLOW CURVE

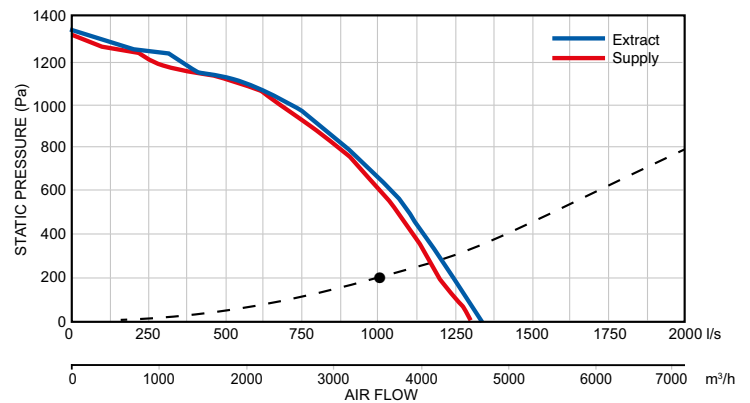

POWER CONSUMPTION

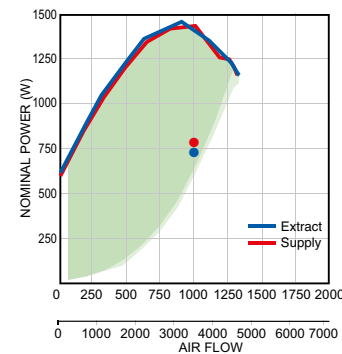

Note: Green area denotes power consumption range. Power consumption depends on system installation.
+ excludes motors. Motor warranty one year from date of purchase.

HEAT RECOVERY EFFICIENCY

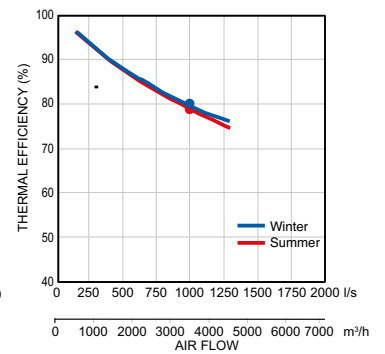

Winter Operation:

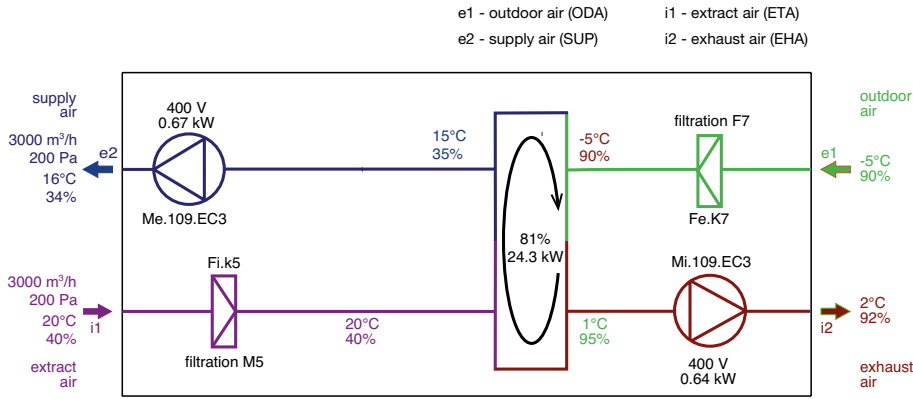

Note: AHU functions diagram. Inlet and outlet location may differ from actual position and port configuration.

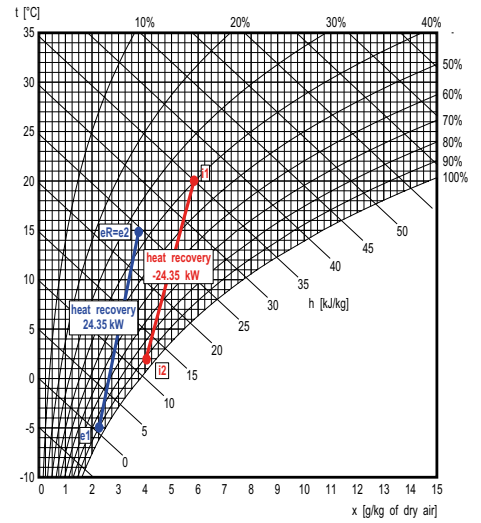

Supply

	Description	t [°C]	RH [%]
e1	Outdoor air	-5.0	90
e2	Supply air	15.8	34

Exhaust

	Description	t [°C]	RH [%]
i1	Extract Air	20.0	40
i2	Exhaust Air	1.3	92

Summer Operation:

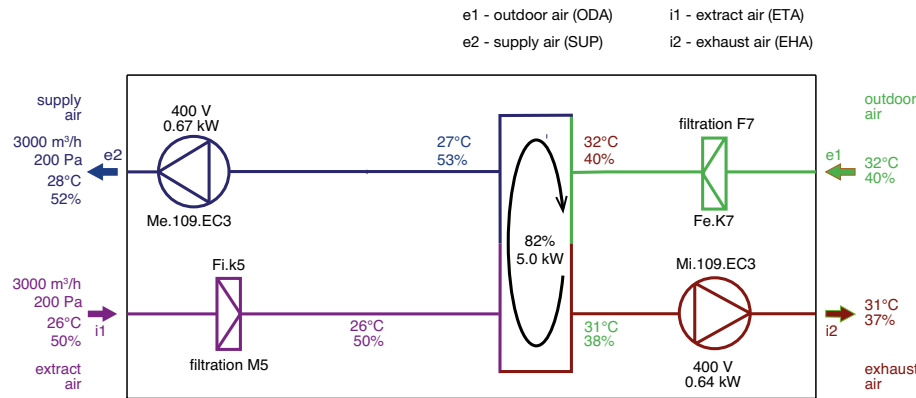

Note: AHU functions diagram. Inlet and outlet location may differ from actual position and port configuration.

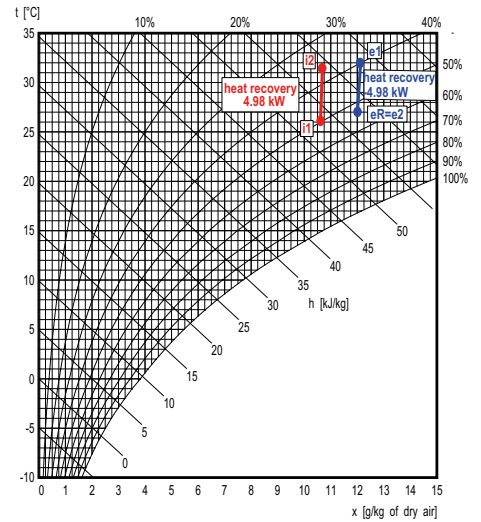

Supply

	Description	t [°C]	RH [%]
e1	Outdoor Air	32.0	40
e2	Supply Air	27.6	52

Exhaust

	Description	t [°C]	RH [%]
i1	Extract Air	26.0	50
i2	Exhaust Air	31.4	37

FILTERS

Filtration	Supply	Extract	Accessories (part of delivery)
Type	Pleated Cartridge		Pfe dirty filter pressure switch for supply air Pfi dirty filter pressure switch for extract air
Filtration class	ePM2,5 65 % (F7)	ePM10 70 % (M5)	
Number of filters	2	2	
Filter cartridge size	750x495x96	750x495x96	

Duplexvent Rotary Roof DV4000

Commercial MVHR
with rotary thermal wheel - Outdoor

OPTIONAL ACCESSORIES

ELECTRIC HEATER

Electric pre-heater		Supply
Air volume	m ³ /h / l/s	3000 / 833
Maximum heating capacity	kW	9.0
Voltage	V	400
Connection ports	mm	300x600

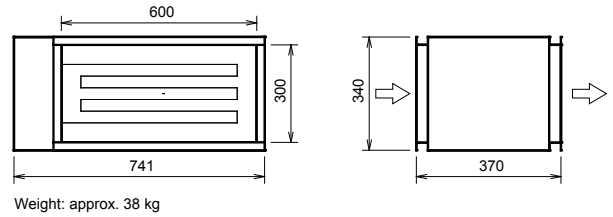

WATER HEATING COIL

Water heating coil		Supply
Heating medium		21% Ethylene glycol
Air volume	m ³ /h / l/s	3000 / 833
Temperature at inlet (after heat recovery)	°C	15
Temperature at outlet (downstream of the heater)	°C	19
Heating capacity	kW	4.9
Heating medium temperature drop	°C	70 / 50
Medium flow (from source)	l/h	211
Connection dimension (hydraulic kit)		5/4" female

Note: The figures above have been measured at 3000 m³/h and 200 Pa. Please use the Duplexvent Selection Software to calculate measurements at other performance levels.

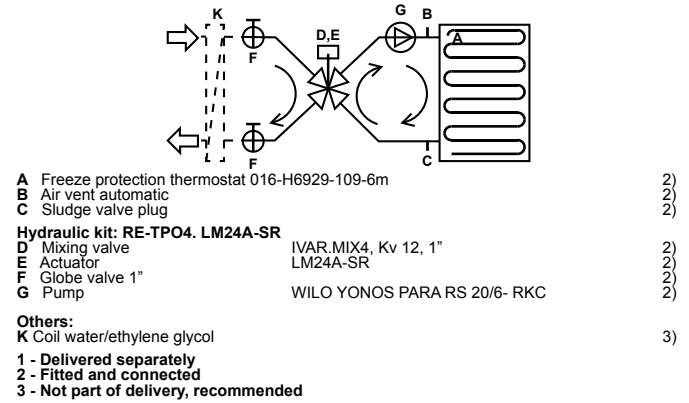

HEATING CAPACITY

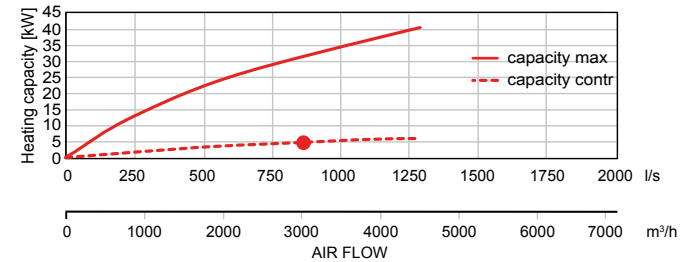

WATER COOLING COIL

Water cooling coil		Supply
Cooling medium		21% Ethylene glycol
Air volume	m ³ /h / l/s	3000 / 833
Temperature at inlet (after heat recovery)	°C	27
Temperature at outlet (downstream of the cooling coil)	°C	16
Inlet relative humidity (after heat recovery)	% RH	53
Outlet relative humidity (downstream of the cooling coil)	% RH	86
Cooling capacity	kW	15.5
Condensate production	l/h	7
Water temperature drop	°C	6 / 12
Medium flow (at max. capacity)	l/h	2760
Medium-side pressure drop		
in heat exchanger	kPa	15.8
in valve	kPa	7.45
Connection dimension		5/4" female

Note: The figures above have been measured at 3000 m³/h and 200 Pa. Please use the Duplexvent Selection Software to calculate measurements at other performance levels.

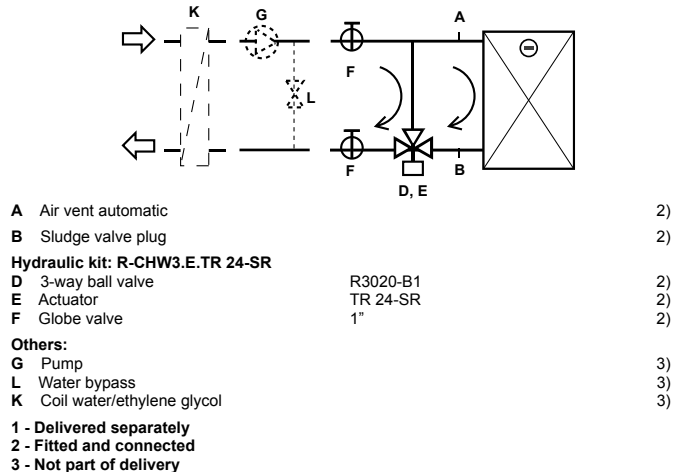

COOLING CAPACITY

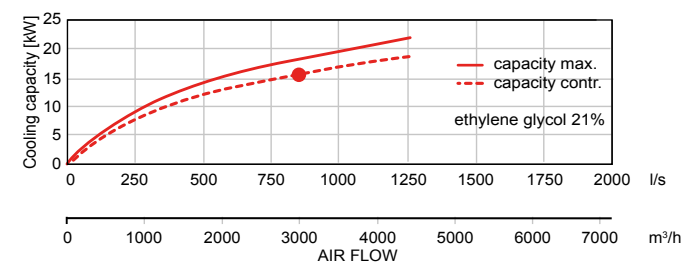

DX COIL

DX coil		Supply
Air volume	m ³ /h / l/s	3000 / 833
Temperature at inlet (after heat recovery)	°C	27
Temperature at outlet (downstream of the DX coil)	°C	16
Inlet relative humidity (after heat recovery)	% RH	53
Outlet relative humidity (downstream of the DX coil)	% RH	78
Cooling capacity	kW	13.88
Condensate production	l/h	10
Refrigerant type		R410A
Evaporating temperature	°C	11

Note: The figures above have been measured at 3000 m³/h and 200 Pa. Please use the Duplexvent Selection Software to calculate measurements at other performance levels.

COOLING CAPACITY

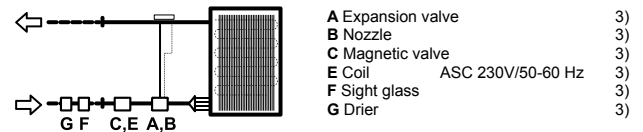
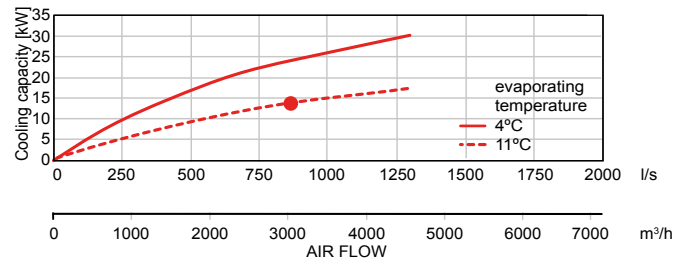

3 Not part of delivery, recommended type mentioned

DIMENSIONS

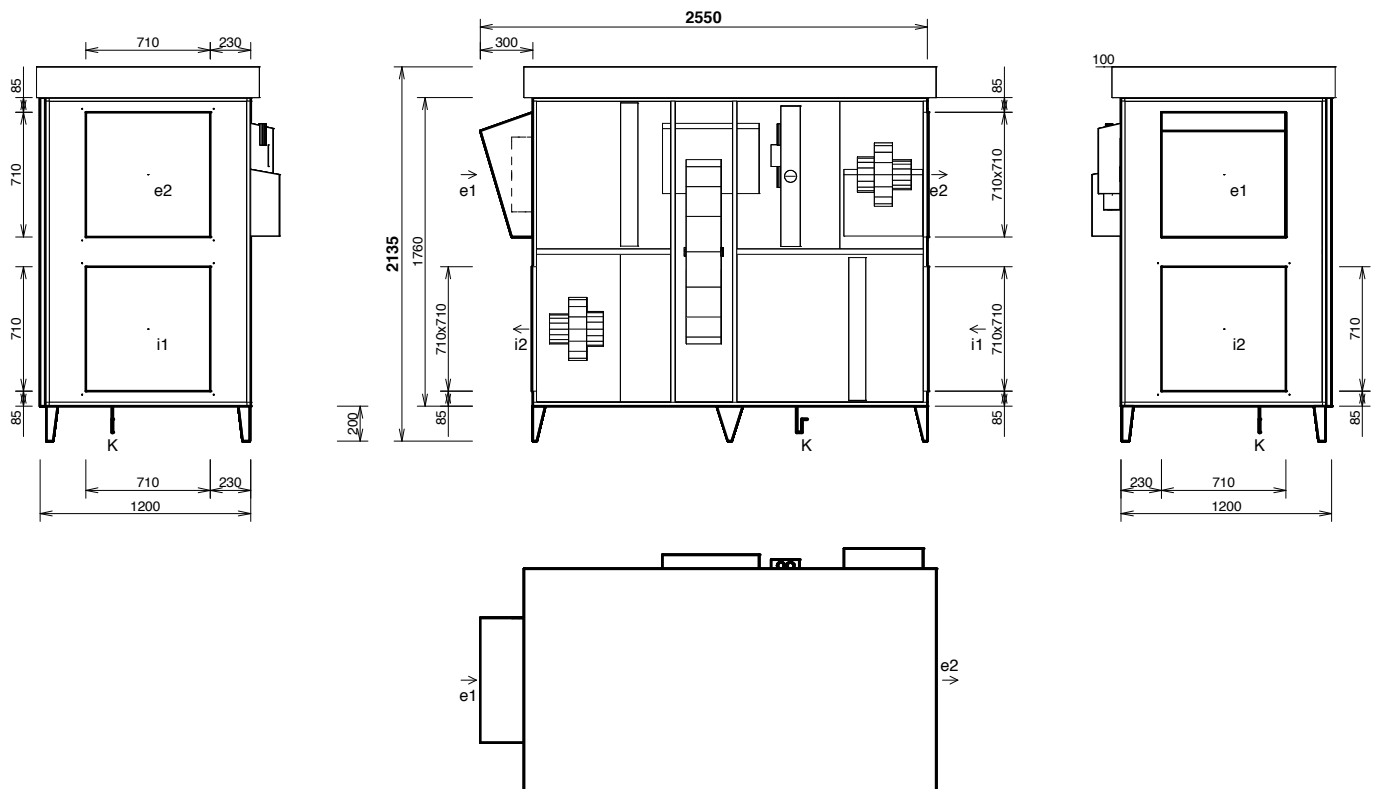

Connections	Type	Dimensions	Optional components
e1	e1- outdoor air (ODA)	710x710mm	Shutoff damper
e2	e2- supply air (SUP)	710x710mm	Flexible connection
i1	i1- extract air (ETA)	710x710mm	Shutoff damper, Flexible connection
i2	i2- exhaust air (EHA)	710x710mm	Flexible connection
K	condensate drain	Ø 32 mm/40 mm	Condensate pump

Notice:

- Unit delivered as 1 piece
- Door is 3 parts
- Diagram is intended only for basic information, binding dimensions receive at device delivery, or on request from the manufacturer
- Bolt holes for duct connection (for one port): 4x M6

Duplexvent Rotary Roof DV5000

Commercial MVHR
with rotary thermal wheel - Outdoor



KEY FEATURES

- Air volume up to 4000 m³/h at 200 Pa according to ErP 2018
- Weather protection hoods and a roof
- Highly efficient, certified by Eurovent rotary heat exchanger, up to 85% thermal efficiency
- Low SFP and energy saving EC fans
- Digital touchscreen or manual controller or BMS
- VAV control compatibility
- Filters: ePM2,5 65 % (F7), ePM10 70 % (M5) or Coarse 60 % (G4)
- Optional equipment: recirculation damper, heating or cooling coils, purge chamber
- Optional constant flow / pressure mode
- 2 year warranty+

PERFORMANCE

Ventilation		Supply Air	Extract Air
Air volume @ 200 Pa	m ³ /h / l/s	4000 / 1111	4000 / 1111
Nominal voltage	V	400	400
Nominal power (at operation point)	kW	0.8	0.8
Fan Speed	min ⁻¹	2152	2125
Max power input	kW	2.5	2.5
Max current	A	3.8	3.8
Fan Type		EC	EC

Note: The figures above have been measured at 4000 m³/h and 200 Pa. Please use the Duplexvent Selection Software to calculate measurements at other performance levels.

AIR FLOW CURVE

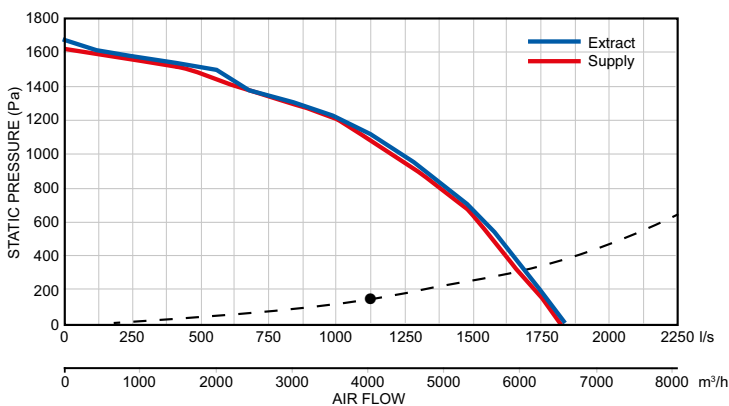

Heat Recovery		Supply Air	Extract Air
Air volume @ 200 Pa	m ³ /h / l/s	4000 / 1111	4000 / 1111
Temperature at inlet	°C	-5	20
Temperature at outlet	°C	14	2
Humidity at inlet	% RH	90	40
Humidity at outlet	% RH	37	95
Heat recovery efficiency winter/summer	% RH	77 / 78	
Humidity recovery efficiency winter/summer	%	41 / 0	
Total heat gain winter/summer	kW	30.8 / 6.3	
Sensible heat gain winter/summer	kW	24.9 / 6.0	
Latent heat gain winter/summer	kW	5.9 / 0	
Heat exchanger speed	RPM	10-13	
Type of heat exchanger		Thermal Rotary Wheel	
Part No.		90000731	

Note: The figures above have been measured at 4000 m³/h and 200 Pa. Please use the Duplexvent Selection Software to calculate measurements at other performance levels.

POWER CONSUMPTION

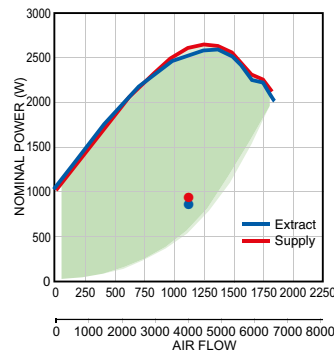

HEAT RECOVERY EFFICIENCY

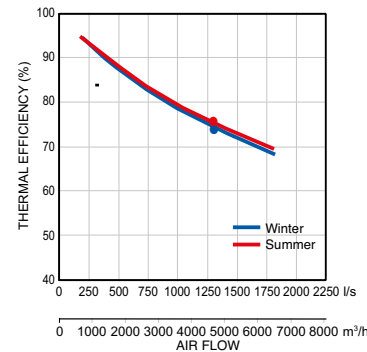

Note: Green area denotes power consumption range. Power consumption depends on system installation.
+ excludes motors. Motor warranty one year from date of purchase.

Sound Power Level L _w	Total	63 Hz	125 Hz	250 Hz	500 Hz	1 kHz	2 kHz	4 kHz	8 kHz
	dB (A)								
Outdoor air e1	62	32	54	58	56	54	50	43	25
Supply air e2	87	59	69	79	83	81	75	69	61
Extract air i1	63	39	56	58	55	54	50	43	<25
Exhaust air i2	87	59	69	79	84	80	75	69	61
Breakout noise	63	42	47	60	58	52	41	35	<25
Sound Pressure Level L _p measured at 3m at inlet e1	42	<25	33	38	35	34	29	<25	<25
Sound Pressure Level L _p measured at 3m	42	<25	27	39	37	32	<25	<25	<25

Note: The figures above have been measured at 4000 m³/h and 200 Pa. Please use the Duplexvent Selection Software to calculate measurements at other performance levels.

Winter Operation:

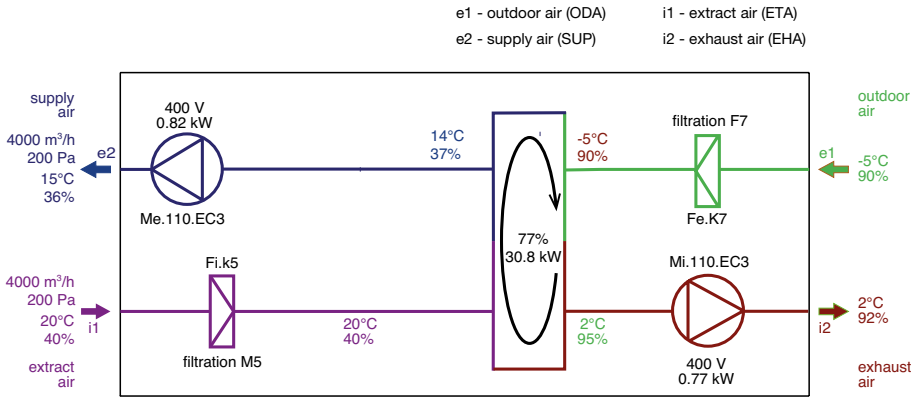

Note: AHU functions diagram. Inlet and outlet location may differ from actual position and port configuration.

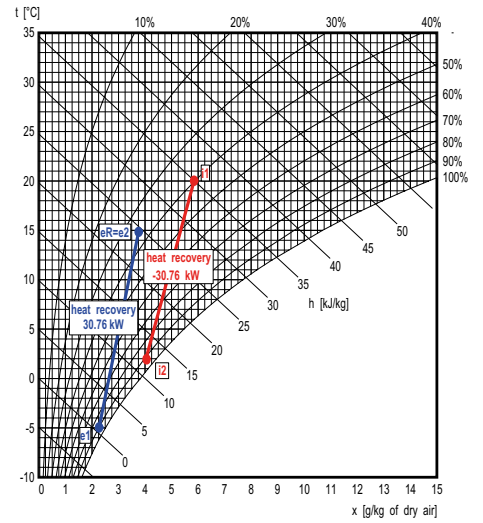

Supply

	Description	t [°C]	RH [%]
e1	Outdoor air	-5.0	90
e2	Supply air	14.7	36

Exhaust

	Description	t [°C]	RH [%]
i1	Extract Air	20.0	40
i2	Exhaust Air	2	92

Summer Operation:

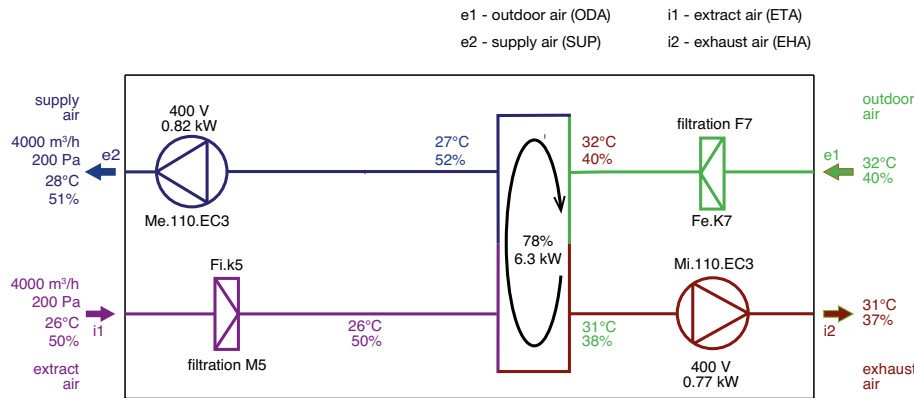

Note: AHU functions diagram. Inlet and outlet location may differ from actual position and port configuration.

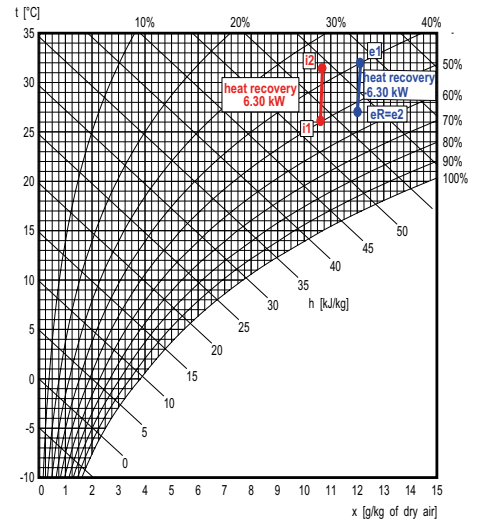

Supply

	Description	t [°C]	RH [%]
e1	Outdoor Air	32.0	40
e2	Supply Air	27.8	51

Exhaust

	Description	t [°C]	RH [%]
i1	Extract Air	26.0	50
i2	Exhaust Air	31.1	37

FILTERS

Filtration	Supply	Extract	Accessories (part of delivery)
Type	Pleated Cartridge		Pfe dirty filter pressure switch for supply air Pfi dirty filter pressure switch for extract air
Filtration class	ePM2,5 65 % (F7)	ePM10 70 % (M5)	
Number of filters	2	2	
Filter cartridge size	750x495x96	750x495x96	

Duplexvent Rotary Roof DV5000

Commercial MVHR
with rotary thermal wheel - Outdoor

OPTIONAL ACCESSORIES

ELECTRIC HEATER

Electric pre-heater		Supply
Air volume	m ³ /h / l/s	4000 / 1111
Maximum heating capacity	kW	13.5
Voltage	V	400
Connection ports	mm	300x600

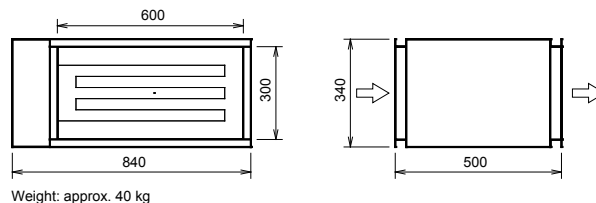

WATER HEATING COIL

Water heating coil		Supply
Heating medium		21% Ethylene glycol
Air volume	m ³ /h / l/s	4000 / 1111
Temperature at inlet (after heat recovery)	°C	14
Temperature at outlet (downstream of the heater)	°C	20
Heating capacity	kW	7.3
Heating medium temperature drop	°C	70 / 50
Medium flow (from source)	l/h	316
Connection dimension (hydraulic kit)		5/4" female

Note: The figures above have been measured at 4000 m³/h and 200 Pa. Please use the Duplexvent Selection Software to calculate measurements at other performance levels.

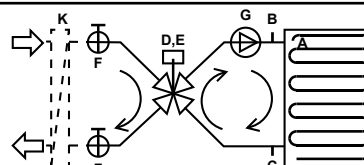

- A Freeze protection thermostat 016-H6929-109-6m
 - B Air vent automatic
 - C Sludge valve plug
 - Hydraulic kit: RE-TPO4. LM24A-SR
 - D Mixing valve
 - E Actuator
 - F Globe valve 1"
 - G Pump
 - Others:
 - K Coil water/ethylene glycol
- 1 - Delivered separately
 2 - Fitted and connected
 3 - Not part of delivery, recommended

HEATING CAPACITY

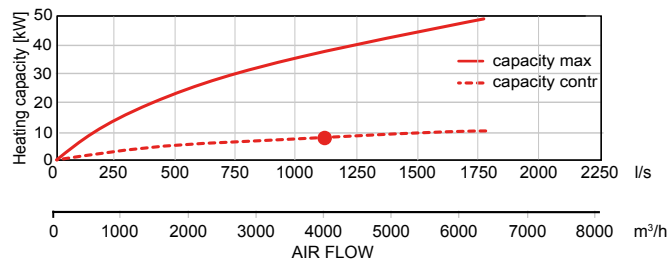

WATER COOLING COIL

Water cooling coil		Supply
Cooling medium		21% Ethylene glycol
Air volume	m ³ /h / l/s	4000 / 1111
Temperature at inlet (after heat recovery)	°C	27
Temperature at outlet (downstream of the cooling coil)	°C	16
Inlet relative humidity (after heat recovery)	% RH	52
Outlet relative humidity (downstream of the cooling coil)	% RH	85
Cooling capacity	kW	21.4
Condensate production	l/h	10
Water temperature drop	°C	6 / 12
Medium flow (at max. capacity)	l/h	3720
Medium-side pressure drop		
in heat exchanger	kPa	26.85
in valve	kPa	13.52
Connection dimension		5/4" female

Note: The figures above have been measured at 4000 m³/h and 200 Pa. Please use the Duplexvent Selection Software to calculate measurements at other performance levels.

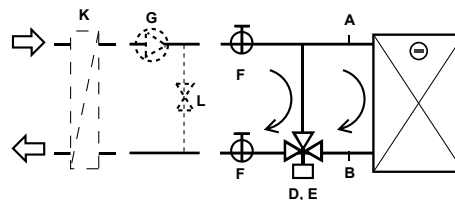

- A Air vent automatic
 - B Sludge valve plug
 - Hydraulic kit: R-CHW3.E.TR 24-SR
 - D 3-way ball valve
 - E Actuator
 - F Globe valve
 - Others:
 - G Pump
 - L Water bypass
 - K Coil water/ethylene glycol
- 1 - Delivered separately
 2 - Fitted and connected
 3 - Not part of delivery

COOLING CAPACITY

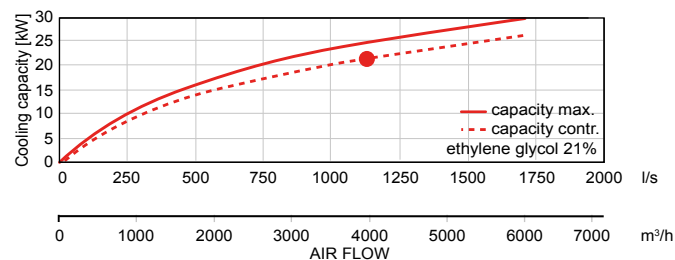

DX COIL

DX coil		Supply
Air volume	m ³ /h / l/s	4000 / 1111
Temperature at inlet (after heat recovery)	°C	27
Temperature at outlet (downstream of the DX coil)	°C	17
Inlet relative humidity (after heat recovery)	% RH	52
Outlet relative humidity (downstream of the DX coil)	% RH	80
Cooling capacity	kW	18.22
Condensate production	l/h	13
Refrigerant type		R410A
Evaporating temperature	°C	10

Note: The figures above have been measured at 4000 m³/h and 200 Pa. Please use the Duplexvent Selection Software to calculate measurements at other performance levels.

COOLING CAPACITY

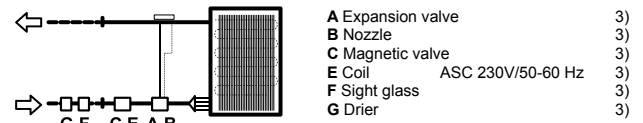
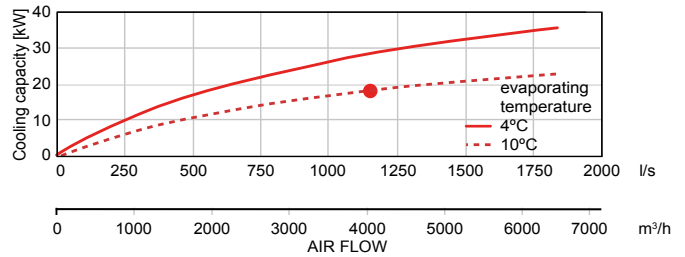

3 Not part of delivery, recommended type mentioned

DIMENSIONS

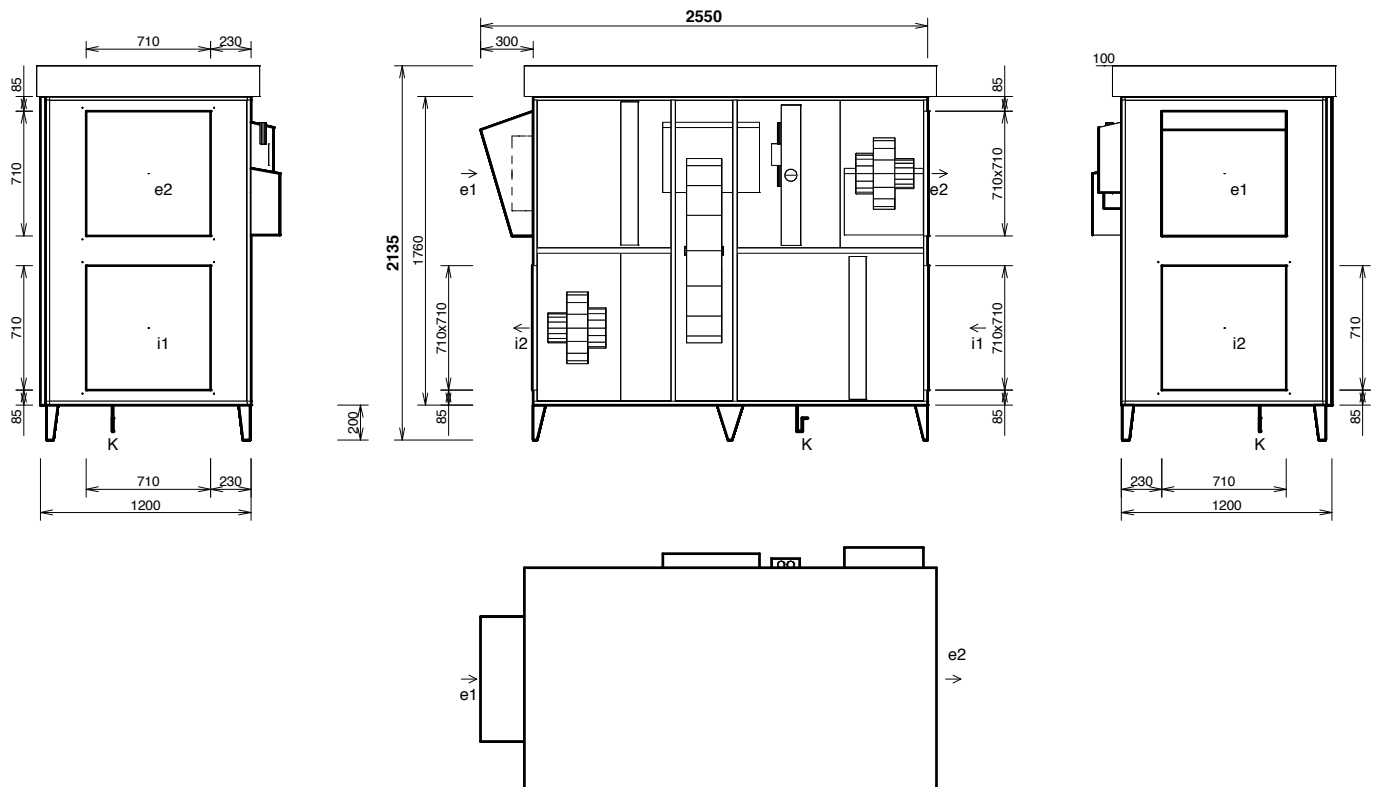

Connections	Type	Dimensions	Optional components
e1	e1- outdoor air (ODA)		Shutoff damper
e2	e2- supply air (SUP)	710x710mm	Flexible connection
i1	i1- extract air (ETA)	710x710mm	Shutoff damper, Flexible connection
i2	i2- exhaust air (EHA)	710x710mm	Flexible connection
K	condensate drain	Ø 32 mm/40 mm	Condensate pump

Notice:

- Diagram is intended only for basic information, binding dimensions receive at device delivery, or on request from the manufacturer
- Bolt holes for duct connection (for one port): 4x M6
- Including base frame heights 200mm

Duplexvent Rotary Roof DV8000

Commercial MVHR
with rotary thermal wheel - Outdoor



PERFORMANCE

Ventilation		Supply Air	Extract Air
Air volume @ 400 Pa	m ³ /h / l/s	7000 / 1944	7000 / 1944
Nominal voltage	V	400	400
Nominal power (at operation point)	kW	2.5	2
Fan Speed	min ⁻¹	2051	1910
Max power input	kW	5.2	5.2
Max current	A	8.4	8.4
Fan Type		EC	EC

Note: The figures above have been measured at 7000 m³/h and 400 Pa. Please use the Duplexvent Selection Software to calculate measurements at other performance levels.

Heat Recovery		Supply Air	Extract Air
Air volume @ 400 Pa	m ³ /h / l/s	7000 / 1944	7000 / 1944
Temperature at inlet	°C	-5	20
Temperature at outlet	°C	14	3
Humidity at inlet	% RH	90	40
Humidity at outlet	% RH	31	100
Heat recovery efficiency winter/summer	%	75 / 73	
Humidity recovery efficiency winter/summer	%	22 / 0	
Total heat gain winter/summer	kW	47.7 / 10.4	
Sensible heat gain winter/summer	kW	43.0 / 10.0	
Latent heat gain winter/summer	kW	4.7 / 0	
Heat exchanger speed	RPM	10-13	
Type of heat exchanger		Thermal Rotary Wheel	
Part No.		90000571	

Note: The figures above have been measured at 7000 m³/h and 400 Pa. Please use the Duplexvent Selection Software to calculate measurements at other performance levels.

Sound Power Level L _w	Total	63 Hz	125 Hz	250 Hz	500 Hz	1 kHz	2 kHz	4 kHz	8 kHz
	dB (A)								
Outdoor air e1	77	47	61	73	72	69	64	56	51
Supply air e2	95	73	79	86	90	91	86	79	71
Extract air i1	77	53	64	73	73	68	63	54	51
Exhaust air i2	94	71	77	84	89	90	85	77	70
Breakout noise	71	45	49	67	64	62	63	58	43
Sound Pressure Level L _p measured at 3m at inlet e1	56	27	41	53	52	48	43	35	30
Sound Pressure Level L _p measured at 3m	50	<25	28	46	44	42	42	38	<25

Note: The figures above have been measured at 7000 m³/h and 400 Pa. Please use the Duplexvent Selection Software to calculate measurements at other performance levels.

KEY FEATURES

- Air volume up to 7000 m³/h at 400 Pa according to ErP 2018
- Weather protection hoods and a roof
- Highly efficient, certified by Eurovent rotary heat exchanger, up to 85% thermal efficiency
- Low SFP and energy saving EC fans
- Digital touchscreen or manual controller or BMS
- VAV control compatibility
- Filters: ePM2,5 65 % (F7), ePM10 70 % (M5) or Coarse 60 % (G4)
- Optional equipment: recirculation damper, heating or cooling coils, purge chamber
- Optional constant flow / pressure mode
- 2 year warranty+

AIR FLOW CURVE

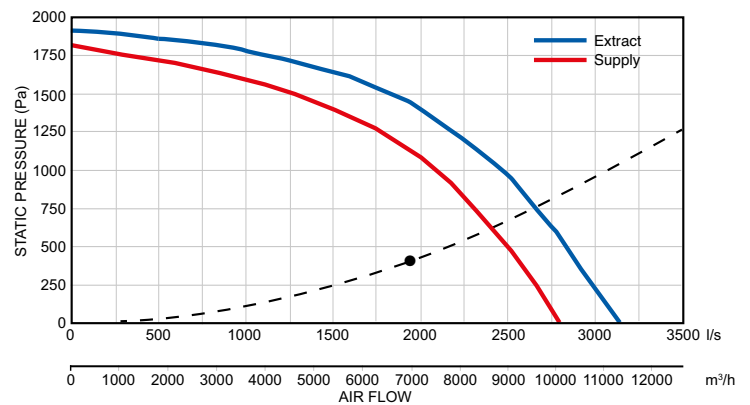

POWER CONSUMPTION

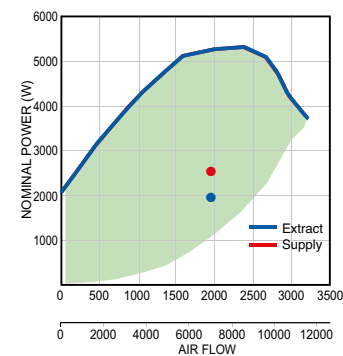

HEAT RECOVERY EFFICIENCY

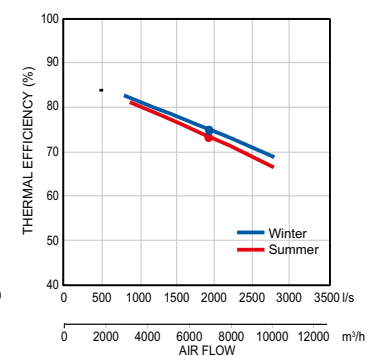

Note: Green area denotes power consumption range. Power consumption depends on system installation.
+ excludes motors. Motor warranty one year from date of purchase.



2018

Winter Operation:

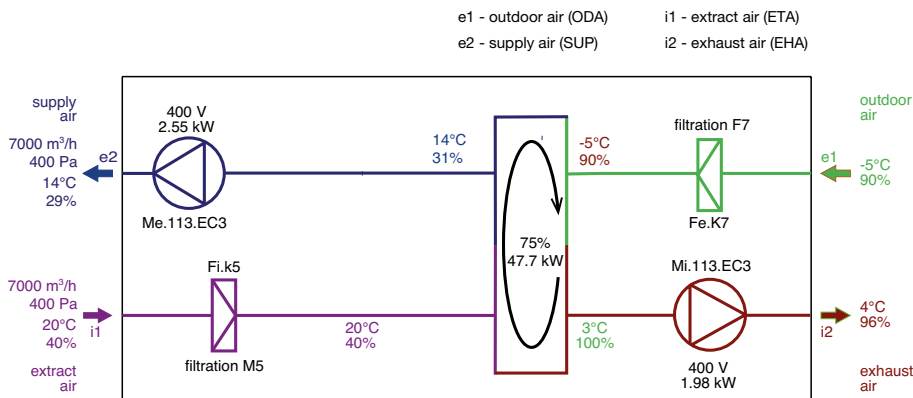

Note: AHU functions diagram. Inlet and outlet location may differ from actual position and port configuration.

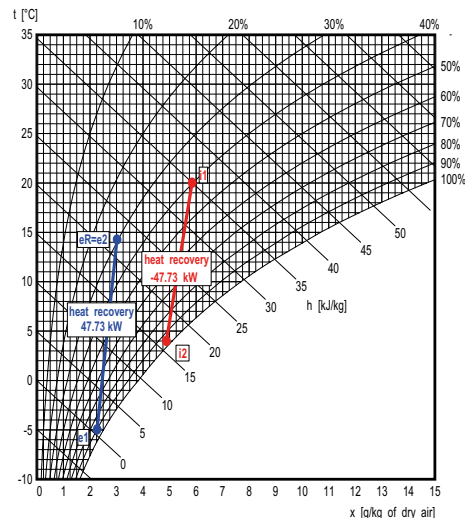

Supply

	Description	t [°C]	RH [%]
e1	Outdoor air	-5.0	90
e2	Supply air	14.5	29

Exhaust

	Description	t [°C]	RH [%]
i1	Extract Air	20.0	40
i2	Exhaust Air	4.1	96

Summer Operation:

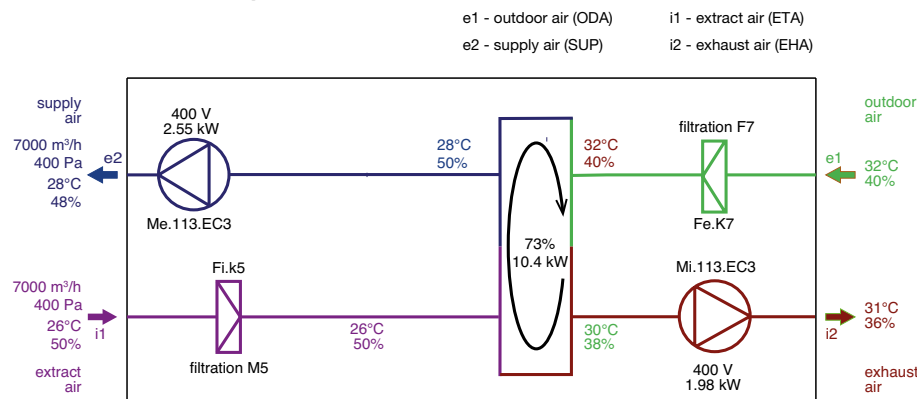

Note: AHU functions diagram. Inlet and outlet location may differ from actual position and port configuration.

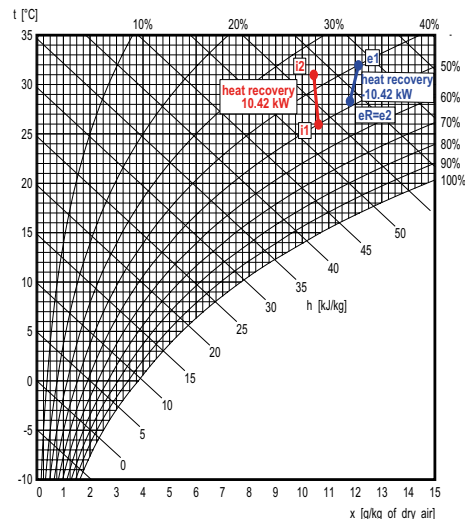

Supply

	Description	t [°C]	RH [%]
e1	Outdoor Air	32.0	40
e2	Supply Air	28.5	48

Exhaust

	Description	t [°C]	RH [%]
i1	Extract Air	26.0	50
i2	Exhaust Air	31	36

FILTERS

Filtration	Supply	Extract	Accessories (part of delivery)
Type	Pleated Cartridge		Pfe dirty filter pressure switch for supply air Pfi dirty filter pressure switch for extract air
Filtration class	ePM2,5 65 % (F7)	ePM10 70 % (M5)	
Number of filters	2	2	
Filter cartridge size	750x495x96	750x495x96	

Duplexvent Rotary Roof DV8000

Commercial MVHR
with rotary thermal wheel - Outdoor

OPTIONAL ACCESSORIES

ELECTRIC HEATER

Electric pre-heater		Supply
Air volume	m ³ /h / l/s	7000 / 1944
Maximum heating capacity	kW	54.0
Voltage	V	400
Connection ports	mm	500x800

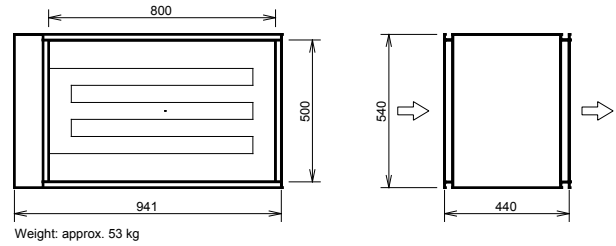

WATER HEATING COIL

Water heating coil		Supply
Heating medium		21% Ethylene glycol
Air volume	m ³ /h / l/s	7000 / 1944
Temperature at inlet (after heat recovery)	°C	14
Temperature at outlet (downstream of the heater)	°C	19
Heating capacity	kW	13.1
Heating medium temperature drop	°C	70 / 50
Medium flow (from source)	l/h	565
Connection dimension (hydraulic kit)		5/4" female

Note: The figures above have been measured at 7000 m³/h and 400 Pa. Please use the Duplexvent Selection Software to calculate measurements at other performance levels.

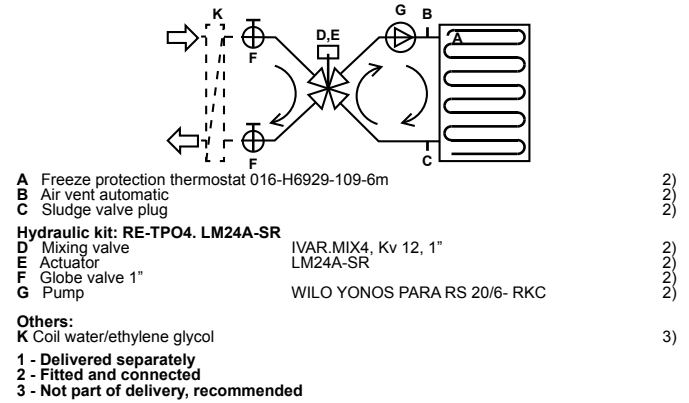

HEATING CAPACITY

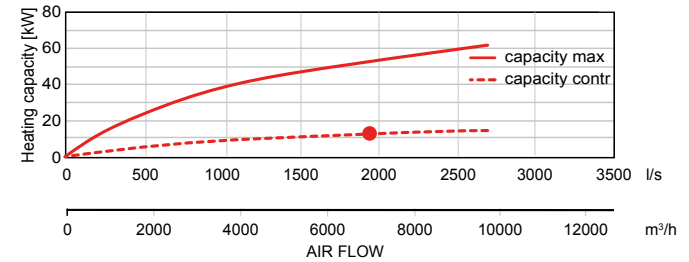

WATER COOLING COIL

Water cooling coil		Supply
Cooling medium		21% Ethylene glycol
Air volume	m ³ /h / l/s	7000 / 1944
Temperature at inlet (after heat recovery)	°C	28
Temperature at outlet (downstream of the cooling coil)	°C	16
Inlet relative humidity (after heat recovery)	% RH	50
Outlet relative humidity (downstream of the cooling coil)	% RH	87
Cooling capacity	kW	37.2
Condensate production	l/h	16
Water temperature drop	°C	6 / 12
Medium flow (at max. capacity)	l/h	5800
Medium-side pressure drop		
in heat exchanger	kPa	30.31
in valve	kPa	32.88
Connection dimension		5/4" female

Note: The figures above have been measured at 7000 m³/h and 400 Pa. Please use the Duplexvent Selection Software to calculate measurements at other performance levels.

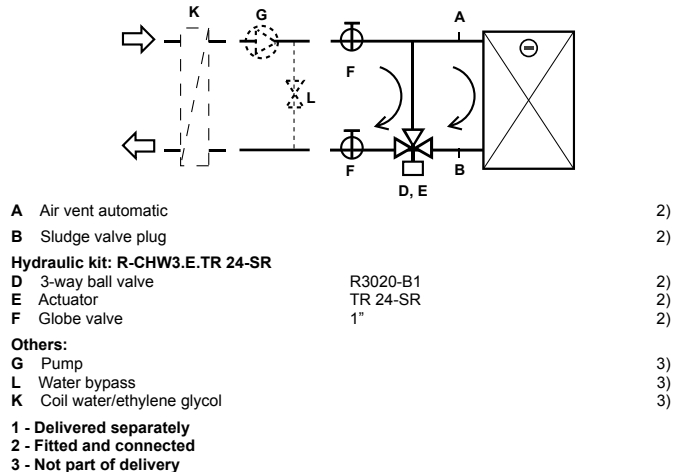

COOLING CAPACITY

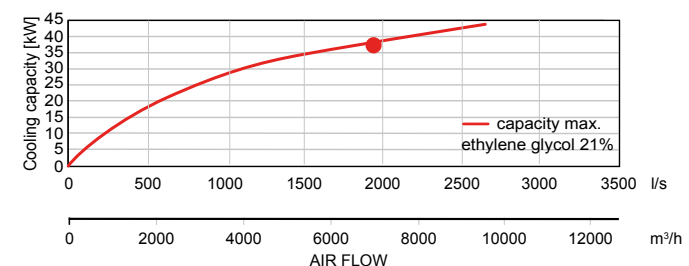

DX COIL

DX coil		Supply
Air volume	m ³ /h / l/s	7000 / 1944
Temperature at inlet (after heat recovery)	°C	28
Temperature at outlet (downstream of the DX coil)	°C	16
Inlet relative humidity (after heat recovery)	% RH	50
Outlet relative humidity (downstream of the DX coil)	% RH	84
Cooling capacity	kW	34.13
Condensate production	l/h	19
Refrigerant type		R410A
Evaporating temperature	°C	5

Note: The figures above have been measured at 7000 m³/h and 400 Pa. Please use the Duplexvent Selection Software to calculate measurements at other performance levels.

COOLING CAPACITY

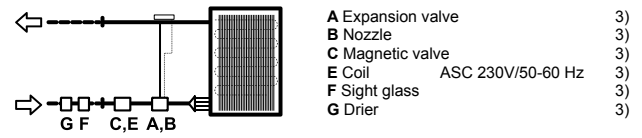
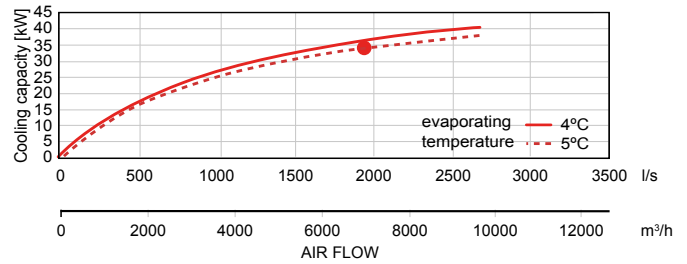

3 Not part of delivery, recommended type mentioned

DIMENSIONS

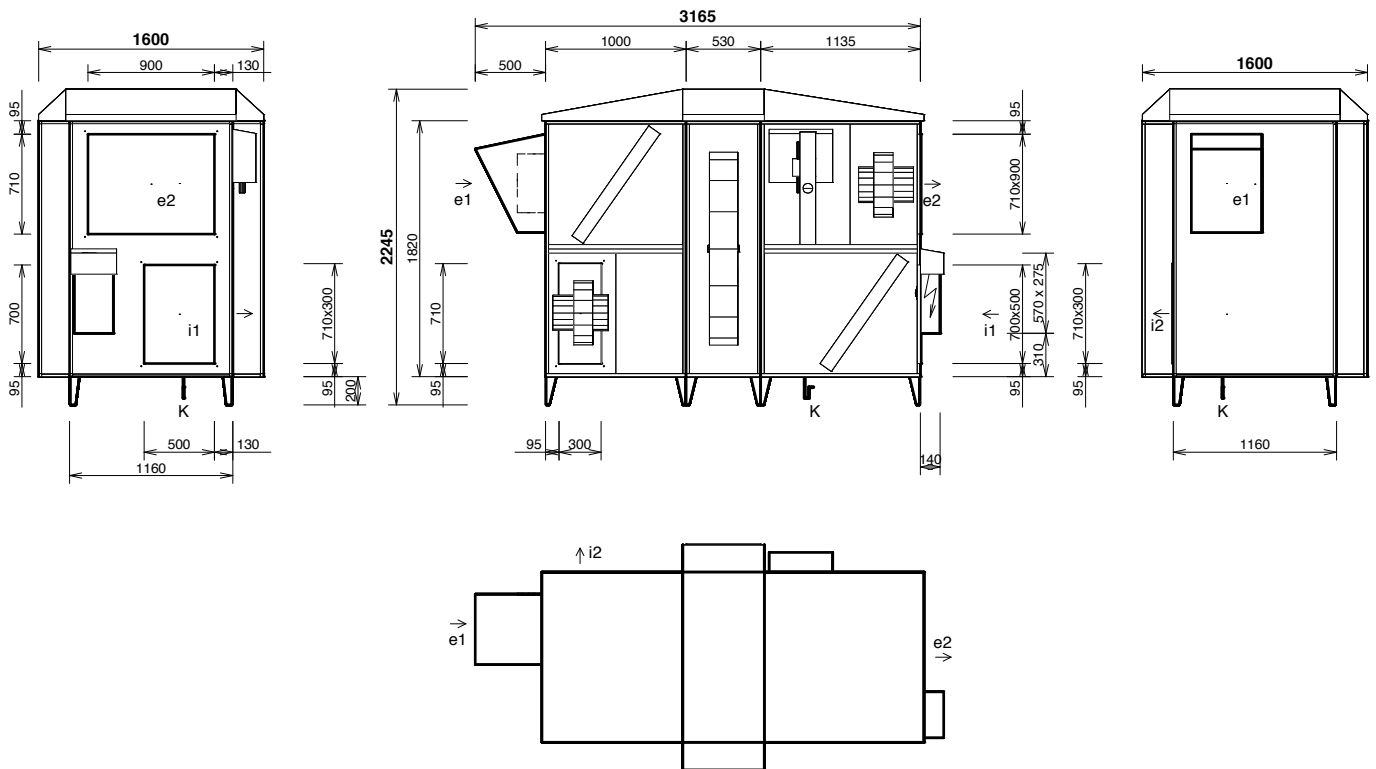

Connections	Type	Dimensions	Optional components
e1	e1- outdoor air (ODA)		Shutoff damper
e2	e2- supply air (SUP)	710x900mm	Flexible connection
i1	i1- extract air (ETA)	700x500mm	Shutoff damper, Flexible connection
i2	i2- exhaust air (EHA)	300x710mm	Flexible connection
K	condensate drain	Ø 32 mm/40 mm	Condensate pump

Notice:

- Unit delivered in 3 parts
- Diagram is intended only for basic information, binding dimensions receive at device delivery, or on request from the manufacturer
- Bolt holes for duct connection (for one port): 4x M6
- Including base frame heights 200mm

Duplexvent Rotary Roof DV12000

Commercial MVHR
with rotary thermal wheel - Outdoor



PERFORMANCE

Ventilation		Supply Air	Extract Air
Air volume @ 400 Pa	m ³ /h / l/s	8000 / 2222	8000 / 2222
Nominal voltage	V	400	400
Nominal power (at operation point)	kW	2.8	2.1
Fan Speed	min ⁻¹	1743	1598
Max power input	kW	5.4	5.4
Max current	A	8.6	8.6
Fan Type		EC	EC

Note: The figures above have been measured at 8000 m³/h and 400 Pa. Please use the Duplexvent Selection Software to calculate measurements at other performance levels.

Heat Recovery		Supply Air	Extract Air
Air volume @ 400 Pa	m ³ /h / l/s	8000 / 2222	8000 / 2222
Temperature at inlet	°C	-5	20
Temperature at outlet	°C	14	3
Humidity at inlet	% RH	90	40
Humidity at outlet	% RH	31	100
Heat recovery efficiency winter/summer	%	76 / 75	
Humidity recovery efficiency winter/summer	%	24 / 0	
Total heat gain winter/summer	kW	55.9 / 12.2	
Sensible heat gain winter/summer	kW	50.1 / 12.0	
Latent heat gain winter/summer	kW	5.8 / 0	
Heat exchanger speed	RPM	10-13	
Type of heat exchanger		Thermal Rotary Wheel	
Part No.		90000572	

Note: The figures above have been measured at 8000 m³/h and 400 Pa. Please use the Duplexvent Selection Software to calculate measurements at other performance levels.

Sound Power Level L _w	Total	dB (A)							
		63 Hz	125 Hz	250 Hz	500 Hz	1 kHz	2 kHz	4 kHz	8 kHz
Outdoor air e1	74	48	63	69	69	67	59	49	38
Supply air e2	96	73	80	85	91	92	86	78	68
Extract air i1	74	53	64	69	69	66	58	47	36
Exhaust air i2	94	72	79	83	90	91	84	77	65
Breakout noise	66	47	55	60	58	60	59	54	40
Sound Pressure Level L _p measured at 3m	53	28	43	48	49	46	39	29	<25
Sound Pressure Level L _p measured at 3m	46	26	35	39	38	40	38	33	<25

Note: The figures above have been measured at 8000 m³/h and 400 Pa. Please use the Duplexvent Selection Software to calculate measurements at other performance levels.

KEY FEATURES

- Air volume up to 8000 m³/h at 400 Pa according to ErP 2018
- Weather protection hoods and a roof
- Highly efficient, certified by Eurovent rotary heat exchanger, up to 85% thermal efficiency
- Low SFP and energy saving EC fans
- Digital touchscreen or manual controller or BMS
- VAV control compatibility
- Filters: ePM2,5 65 % (F7), ePM10 70 % (M5) or Coarse 60 % (G4)
- Optional equipment: recirculation damper, heating or cooling coils, purge chamber
- Optional constant flow / pressure mode
- 2 year warranty+

AIR FLOW CURVE

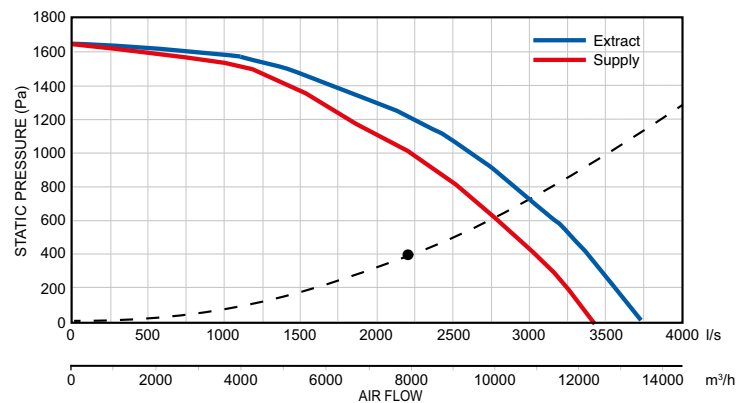

POWER CONSUMPTION

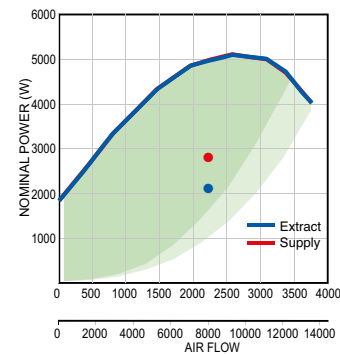

Note: Green area denotes power consumption range. Power consumption depends on system installation.
+ excludes motors. Motor warranty one year from date of purchase.

HEAT RECOVERY EFFICIENCY

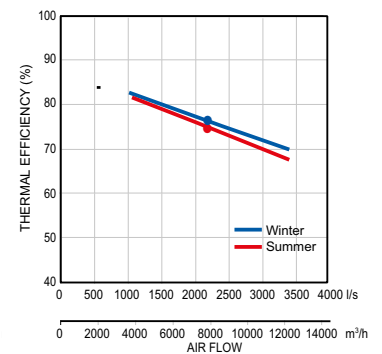

Winter Operation:

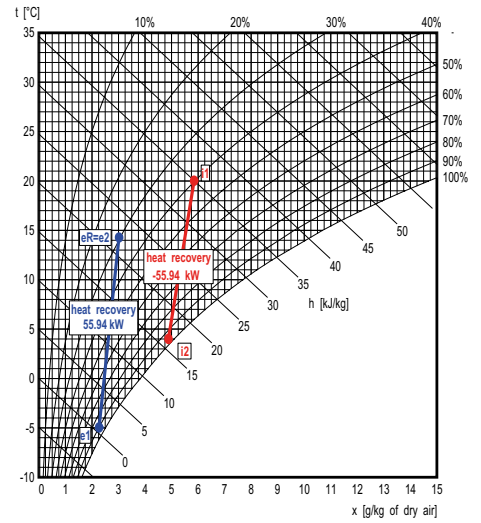
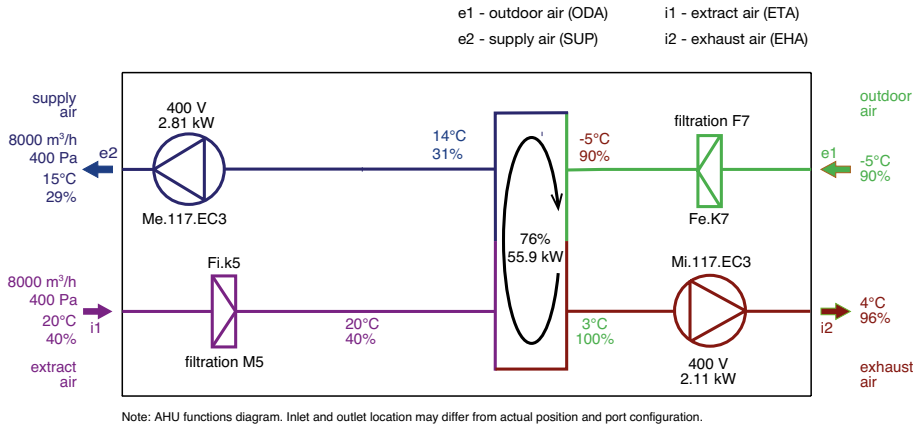

Supply

	Description	t [°C]	RH [%]
e1	Outdoor air	-5.0	90
e2	Supply air	14.4	30

Exhaust

	Description	t [°C]	RH [%]
i1	Extract Air	20.0	40
i2	Exhaust Air	4.1	96

Summer Operation:

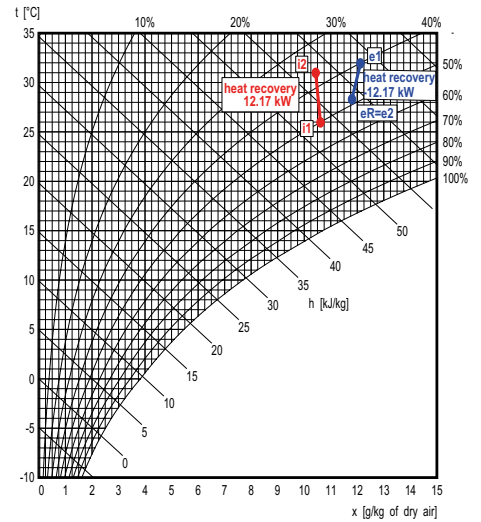
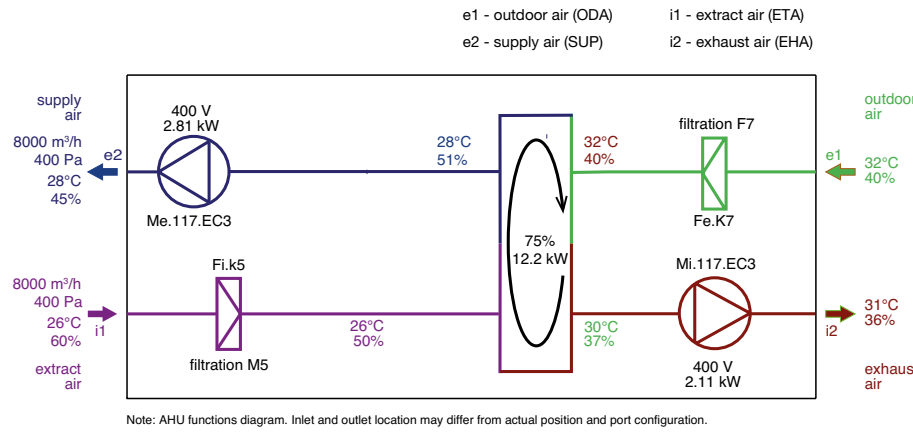

Supply

	Description	t [°C]	RH [%]
e1	Outdoor Air	32.0	40
e2	Supply Air	28.3	48

Exhaust

	Description	t [°C]	RH [%]
i1	Extract Air	26.0	50
i2	Exhaust Air	31.1	36

FILTERS

Filtration	Supply	Extract	Accessories (part of delivery)
Type	Pleated Cartridge		Pfe dirty filter pressure switch for supply air Pfi dirty filter pressure switch for extract air
Filtration class	ePM2,5 65 % (F7)	ePM10 70 % (M5)	
Number of filters	pcs 3	3	
Filter cartridge size	mm 1000x440x96	1000x440x96	

Duplexvent Rotary Roof DV12000

Commercial MVHR
with rotary thermal wheel - Outdoor

OPTIONAL ACCESSORIES

ELECTRIC HEATER

Electric pre-heater		Supply
Air volume	m ³ /h / l/s	8000 / 2222
Maximum heating capacity	kW	54.0
Voltage	V	400
Connection ports	mm	500x800

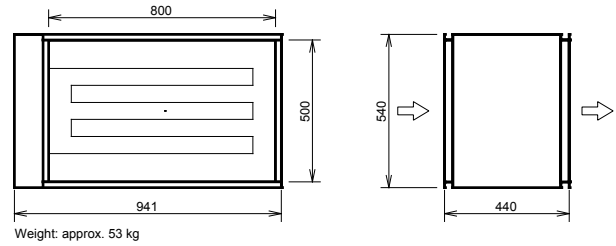

WATER HEATING COIL

Water heating coil		Supply
Heating medium		21% Ethylene glycol
Air volume	m ³ /h / l/s	8000 / 2222
Temperature at inlet (after heat recovery)	°C	14
Temperature at outlet (downstream of the heater)	°C	19
Heating capacity	kW	14.2
Heating medium temperature drop	°C	70 / 50
Medium flow (from source)	l/h	613
Connection dimension (hydraulic kit)		5/4" female

Note: The figures above have been measured at 8000 m³/h and 200 Pa. Please use the Duplexvent Selection Software to calculate measurements at other performance levels.

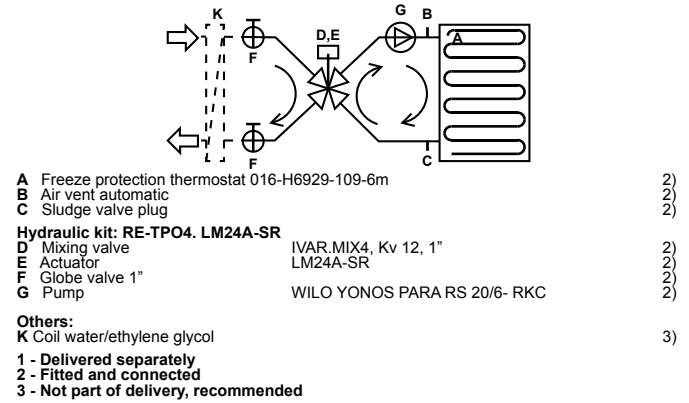

HEATING CAPACITY

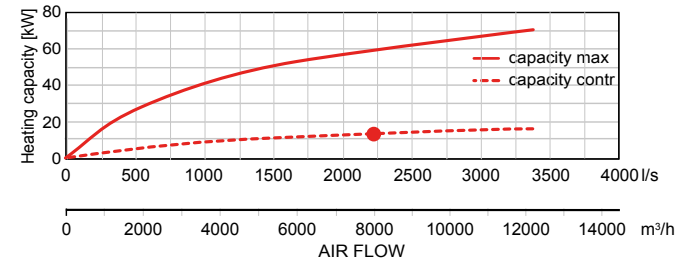

WATER COOLING COIL

Water cooling coil		Supply
Cooling medium		21% Ethylene glycol
Air volume	m ³ /h / l/s	8000 / 2222
Temperature at inlet (after heat recovery)	°C	28
Temperature at outlet (downstream of the cooling coil)	°C	17
Inlet relative humidity (after heat recovery)	% RH	51
Outlet relative humidity (downstream of the cooling coil)	% RH	88
Cooling capacity	kW	39.0
Condensate production	l/h	15
Water temperature drop	°C	6 / 12
Medium flow (at max. capacity)	l/h	5880
Medium-side pressure drop		
in heat exchanger	kPa	12.14
in valve	kPa	33.78
Connection dimension		5/4" female

Note: The figures above have been measured at 8000 m³/h and 400 Pa. Please use the Duplexvent Selection Software to calculate measurements at other performance levels.

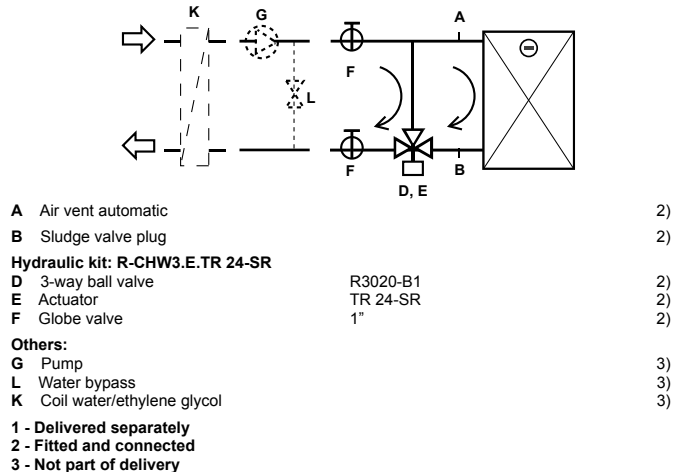

COOLING CAPACITY

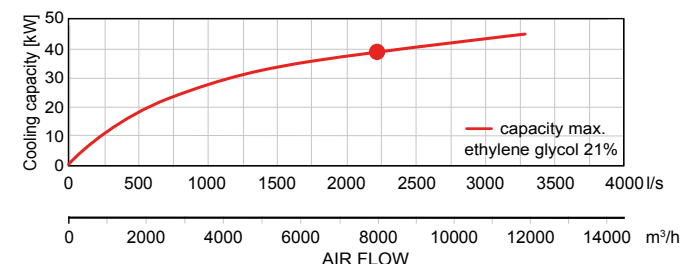

DX COIL

DX coil		Supply
Air volume	m ³ /h / l/s	8000 / 2222
Temperature at inlet (after heat recovery)	°C	28
Temperature at outlet (downstream of the DX coil)	°C	16
Inlet relative humidity (after heat recovery)	% RH	51
Outlet relative humidity (downstream of the DX coil)	% RH	78
Cooling capacity	kW	36.92
Condensate production	l/h	26
Refrigerant type		R410A
Evaporating temperature	°C	8

Note: The figures above have been measured at 8000 m³/h and 400 Pa. Please use the Duplexvent Selection Software to calculate measurements at other performance levels.

COOLING CAPACITY

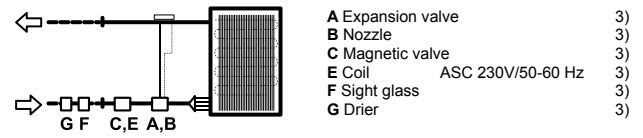
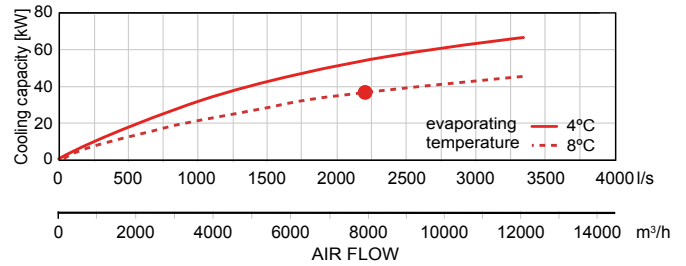

3 Not part of delivery, recommended type mentioned

DIMENSIONS

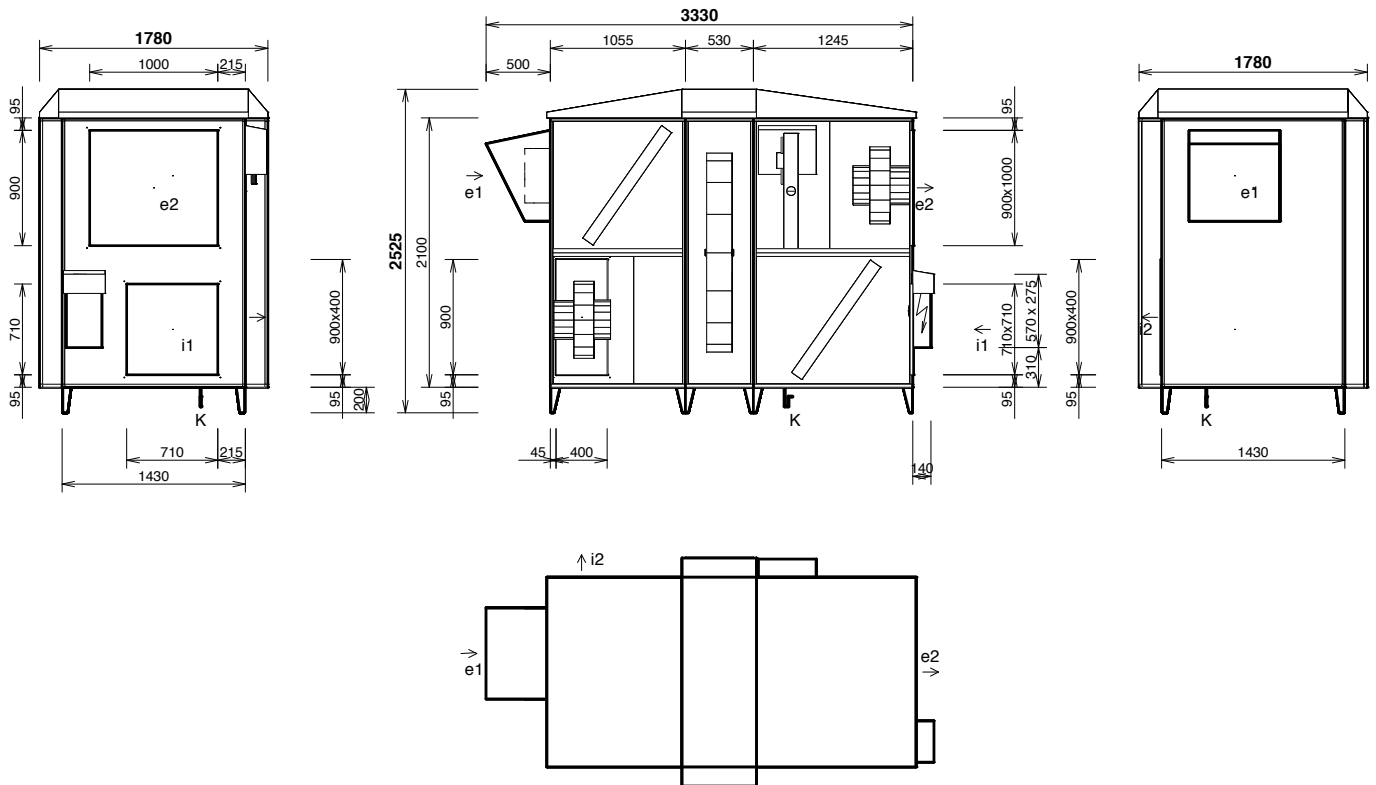

Connections	Type	Dimensions	Optional components
e1	e1- outdoor air (ODA)		Shutoff damper
e2	e2- supply air (SUP)	900x1000mm	Flexible connection
i1	i1- extract air (ETA)	710x710mm	Shutoff damper, Flexible connection
i2	i2- exhaust air (EHA)	400x900mm	Flexible connection
K	condensate drain	Ø 32 mm/40 mm	Condensate pump

Notice:

- Unit delivered in 3 parts
- Diagram is intended only for basic information, binding dimensions receive at device delivery, or on request from the manufacturer
- Bolt holes for duct connection (for one port): 4x M6
- Including base frame heights 200mm

Duplexvent Rotary Roof DV15000

Commercial MVHR
with rotary thermal wheel - Outdoor



PERFORMANCE

Ventilation		Supply Air	Extract Air
Air volume @ 400 Pa	m ³ /h / l/s	10000 / 2778	10000 / 2778
Nominal voltage	V	400	400
Nominal power (at operation point)	kW	4	2.6
Fan Speed	min ⁻¹	1624	1418
Max power input	kW	5.4	5.4
Max current	A	9.4	9.4
Fan Type		EC	EC

Note: The figures above have been measured at 10000 m³/h and 400 Pa. Please use the Duplexvent Selection Software to calculate measurements at other performance levels.

Heat Recovery		Supply Air	Extract Air
Air volume @ 400 Pa	m ³ /h / l/s	10000 / 2778	10000 / 2778
Temperature at inlet	°C	-5	20
Temperature at outlet	°C	14	3
Humidity at inlet	% RH	90	40
Humidity at outlet	% RH	31	100
Heat recovery efficiency winter/summer	%	76 / 74	
Humidity recovery efficiency winter/summer	%	23 / 0	
Total heat gain winter/summer	kW	69.2 / 15.1	
Sensible heat gain winter/summer	kW	62.1 / 15.0	
Latent heat gain winter/summer	kW	7.0 / 0	
Heat exchanger speed	RPM	10-13	
Type of heat exchanger		Thermal Rotary Wheel	
Part No.		90000573	

Note: The figures above have been measured at 10000 m³/h and 400 Pa. Please use the Duplexvent Selection Software to calculate measurements at other performance levels.

Sound Power Level L _w	Total	63 Hz	125 Hz	250 Hz	500 Hz	1 kHz	2 kHz	4 kHz	8 kHz
	dB (A)								
Outdoor air e1	75	52	65	71	70	67	65	56	46
Supply air e2	95	72	80	84	91	91	83	72	57
Extract air i1	73	56	65	69	68	64	61	51	42
Exhaust air i2	92	70	77	82	88	88	81	68	53
Breakout noise	68	46	59	61	61	62	62	57	44
Sound Pressure Level L _p measured at 3m	55	32	44	51	49	46	45	35	25
Sound Pressure Level L _p measured at 3m	48	26	38	40	40	41	42	36	<25

Note: The figures above have been measured at 10000 m³/h and 400 Pa. Please use the Duplexvent Selection Software to calculate measurements at other performance levels.

KEY FEATURES

- Air volume up to 10000 m³/h at 400 Pa according to ErP 2018
- Weather protection hoods and a roof
- Highly efficient, certified by Eurovent rotary heat exchanger, up to 85% thermal efficiency
- Low SFP and energy saving EC fans
- Digital touchscreen or manual controller or BMS
- VAV control compatibility
- Filters: ePM2,5 65 % (F7), ePM10 70 % (M5) or Coarse 60 % (G4)
- Optional equipment: recirculation damper, heating or cooling coils, purge chamber
- Optional constant flow / pressure mode
- 2 year warranty+

AIR FLOW CURVE

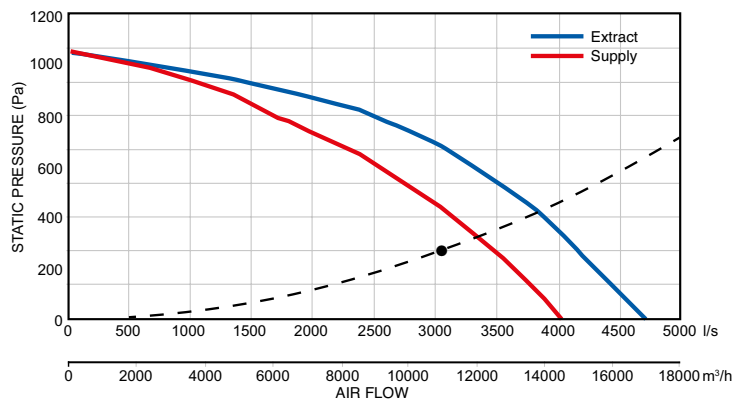

POWER CONSUMPTION

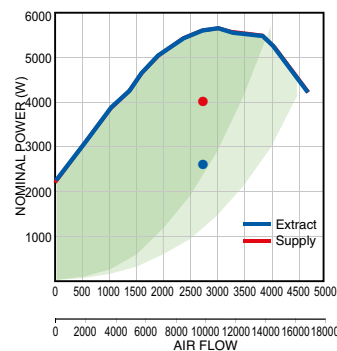

Note: Green area denotes power consumption range. Power consumption depends on system installation.
+ excludes motors. Motor warranty one year from date of purchase.

HEAT RECOVERY EFFICIENCY

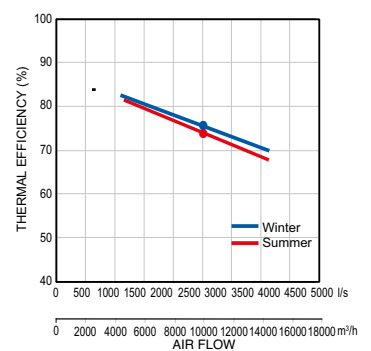

Winter Operation:

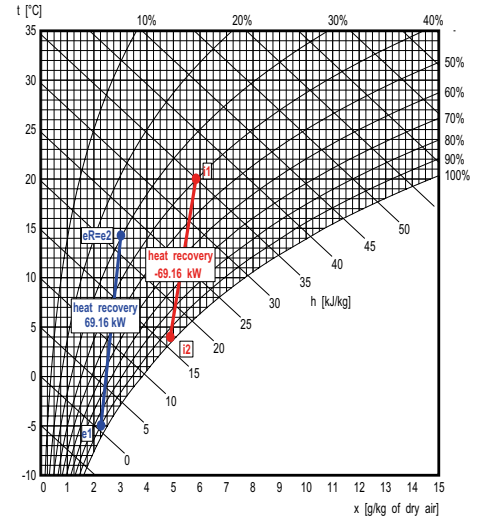
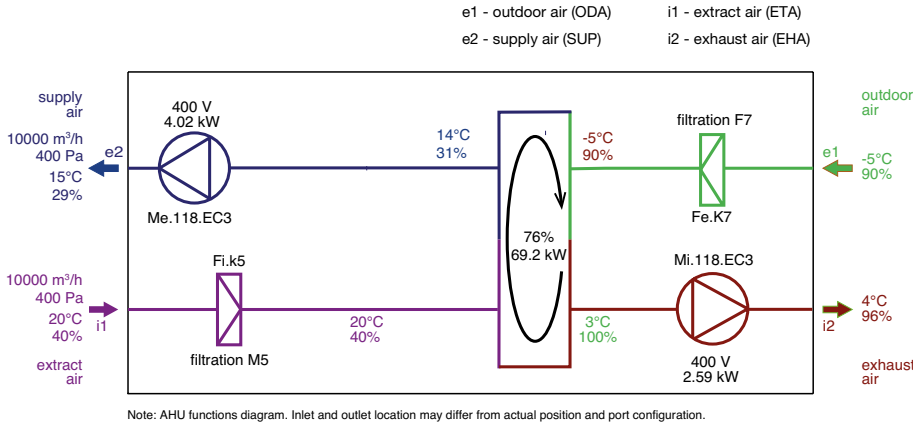

Supply

Description	t [°C]	RH [%]
e1 Outdoor air	-5.0	90
e2 Supply air	14.8	29

Exhaust

Description	t [°C]	RH [%]
i1 Extract Air	20.0	40
i2 Exhaust Air	3.9	96

Summer Operation:

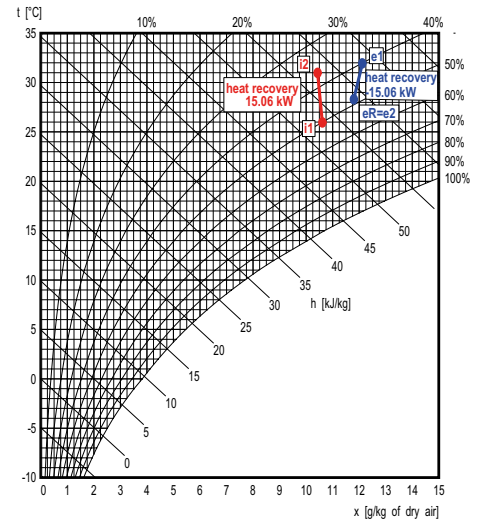
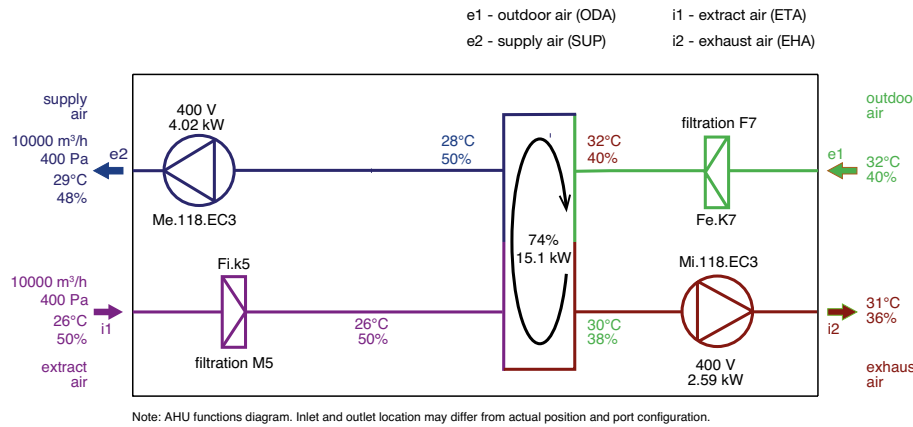

Supply

Description	t [°C]	RH [%]
e1 Outdoor Air	32.0	40
e2 Supply Air	28.5	48

Exhaust

Description	t [°C]	RH [%]
i1 Extract Air	26.0	50
i2 Exhaust Air	31.0	36

FILTERS

Filtration Type	Supply	Extract	Accessories (part of delivery)
	Pleated Cartridge		
Filtration class	ePM2,5 65 % (F7)	ePM10 70 % (M5)	Pfe dirty filter pressure switch for supply air
Number of filters	3	3	Pfi dirty filter pressure switch for extract air
Filter cartridge size	900x533x96	900x533x96	

Duplexvent Rotary Roof DV15000

Commercial MVHR
with rotary thermal wheel - Outdoor

OPTIONAL ACCESSORIES

ELECTRIC HEATER

Electric pre-heater		Supply
Air volume	m ³ /h / l/s	10000 / 2778
Maximum heating capacity	kW	54.0
Voltage	V	400
Connection ports	mm	500x800

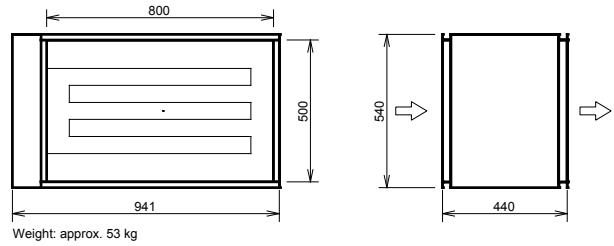

WATER HEATING COIL

Water heating coil		Supply
Heating medium		21% Ethylene glycol
Air volume	m ³ /h / l/s	10000 / 2778
Temperature at inlet (after heat recovery)	°C	14
Temperature at outlet (downstream of the heater)	°C	19
Heating capacity	kW	18
Heating medium temperature drop	°C	70 / 50
Medium flow (from source)	l/h	776
Connection dimension (hydraulic kit)		5/4" female

Note: The figures above have been measured at 10000 m³/h and 400 Pa. Please use the Duplexvent Selection Software to calculate measurements at other performance levels.

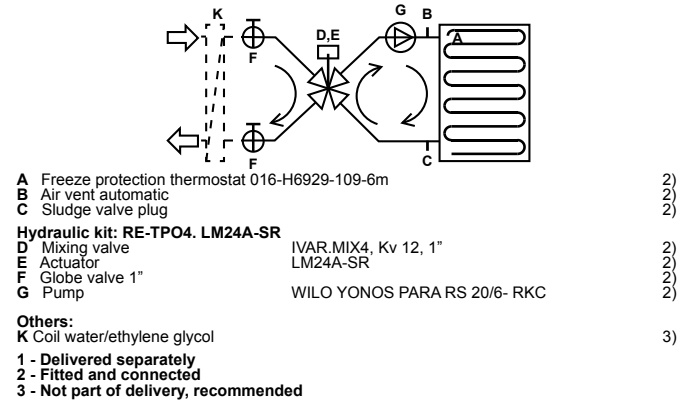

HEATING CAPACITY

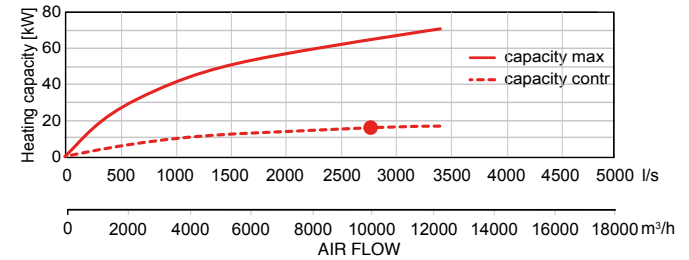

WATER COOLING COIL

Water cooling coil		Supply
Cooling medium		21% Ethylene glycol
Air volume	m ³ /h / l/s	10000 / 2778
Temperature at inlet (after heat recovery)	°C	28
Temperature at outlet (downstream of the cooling coil)	°C	16
Inlet relative humidity (after heat recovery)	% RH	50
Outlet relative humidity (downstream of the cooling coil)	% RH	86
Cooling capacity	kW	55.2
Condensate production	l/h	25
Water temperature drop	°C	6 / 12
Medium flow (at max. capacity)	l/h	8350
Medium-side pressure drop		
in heat exchanger	kPa	33.08
in valve	kPa	68.11
Connection dimension		5/4" female

Note: The figures above have been measured at 10000 m³/h and 400 Pa. Please use the Duplexvent Selection Software to calculate measurements at other performance levels.

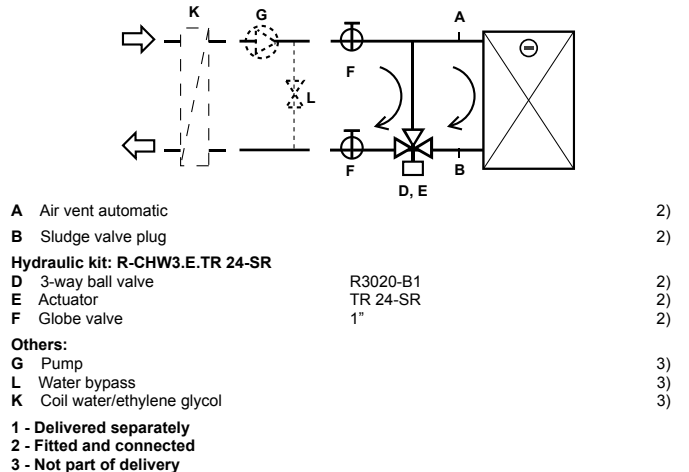

COOLING CAPACITY

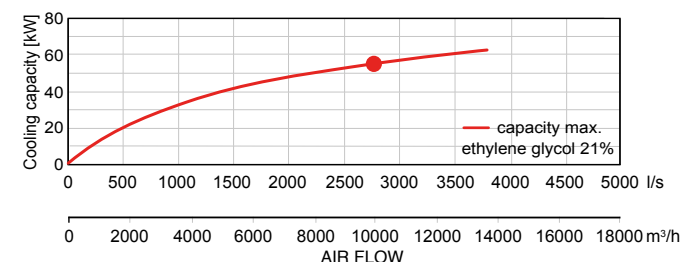

DX COIL

DX coil		Supply
Air volume	m ³ /h / l/s	10000 / 2778
Temperature at inlet (after heat recovery)	°C	28
Temperature at outlet (downstream of the DX coil)	°C	16
Inlet relative humidity (after heat recovery)	% RH	50
Outlet relative humidity (downstream of the DX coil)	% RH	78
Cooling capacity	kW	49.57
Condensate production	l/h	36
Refrigerant type		R410A
Evaporating temperature	°C	8

Note: The figures above have been measured at 10000 m³/h and 400 Pa. Please use the Duplexvent Selection Software to calculate measurements at other performance levels.

COOLING CAPACITY

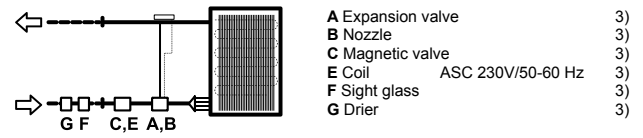
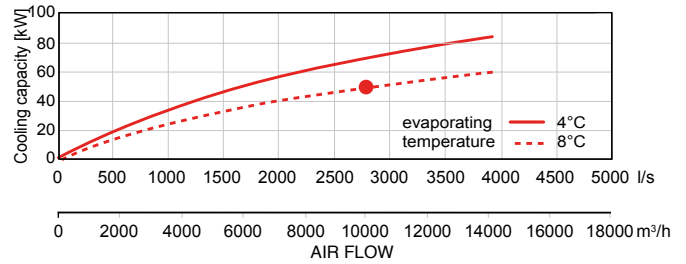

3 Not part of delivery, recommended type mentioned

DIMENSIONS

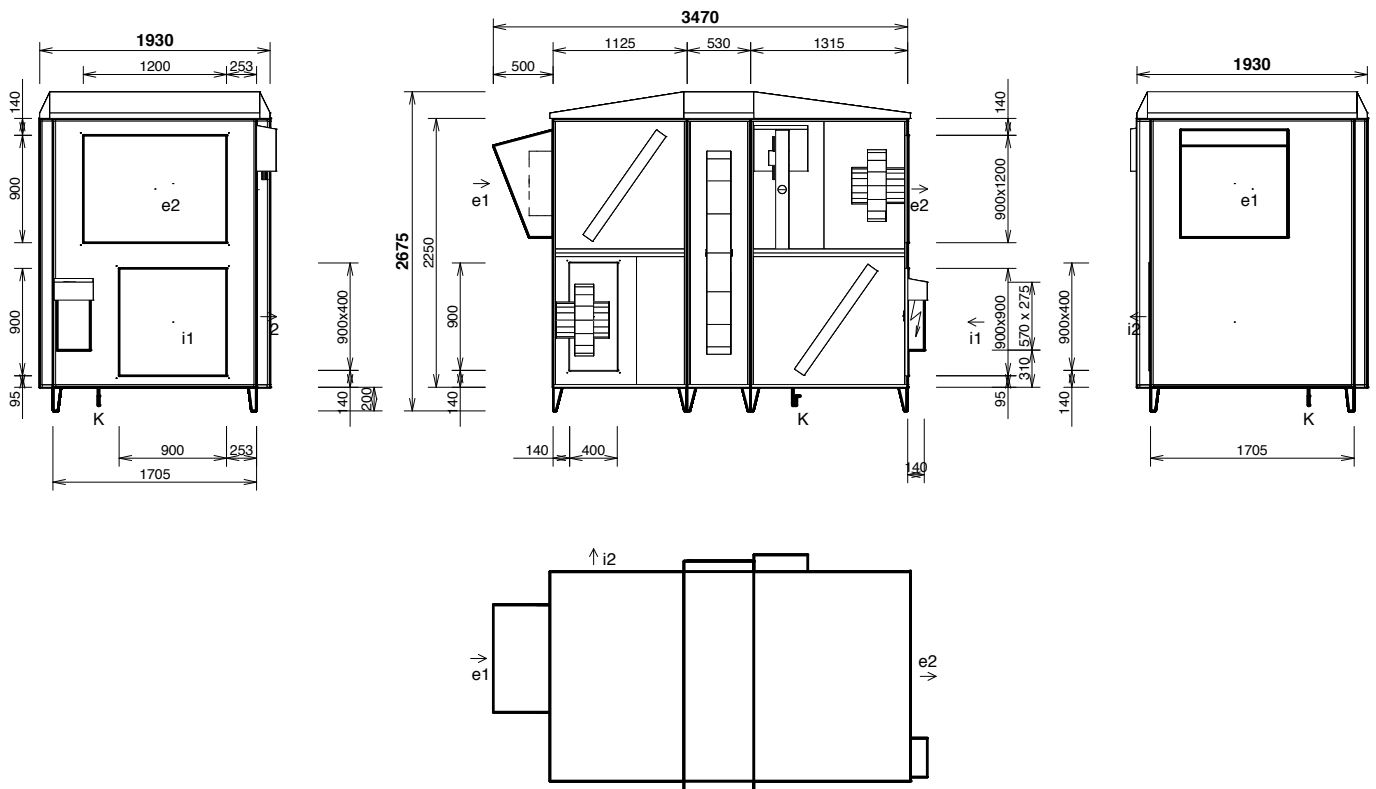

Connections	Type	Dimensions	Optional components
e1	e1- outdoor air (ODA)		Shutoff damper
e2	e2- supply air (SUP)	900x1200mm	Flexible connection
i1	i1- extract air (ETA)	900x900mm	Shutoff damper, Flexible connection
i2	i2- exhaust air (EHA)	400x900mm	Flexible connection
K	condensate drain	Ø 32 mm/40 mm	Condensate pump

Notice:

- Unit delivered in 3 parts
- Diagram is intended only for basic information, binding dimensions receive at device delivery, or on request from the manufacturer
- Bolt holes for duct connection (for one port): 4x M6
- Including base frame heights 200mm

Duplexvent - Advanced Functionality and Control

WEB CONTROL SYSTEM

Duplexvent Commercial Heat Recovery units are delivered with a choice of control options which enables complete functionality of the Flexi, Rotary and Multi eco units.

- Advanced control with digital display
- 100% adjustable EC fan control
- Automatic 100% bypass control for free cooling
- Daily / Weekly programme setting
- Filter monitoring via pressure sensors
- BMS connection (Modbus as standard, BACnet or KNX optional)
- Internet connection with user and service interfaces
- Frost protection facility (heater assisted)
- Outputs for electric / water heater and DX / water cooler
- Zonal ventilation control (winter / summer)
- Constant flow / pressure control
- Temperature control (based on extract or supply air) via 5 built-in temperature sensors
- On-demand ventilation via CO₂, humidity and air quality sensors

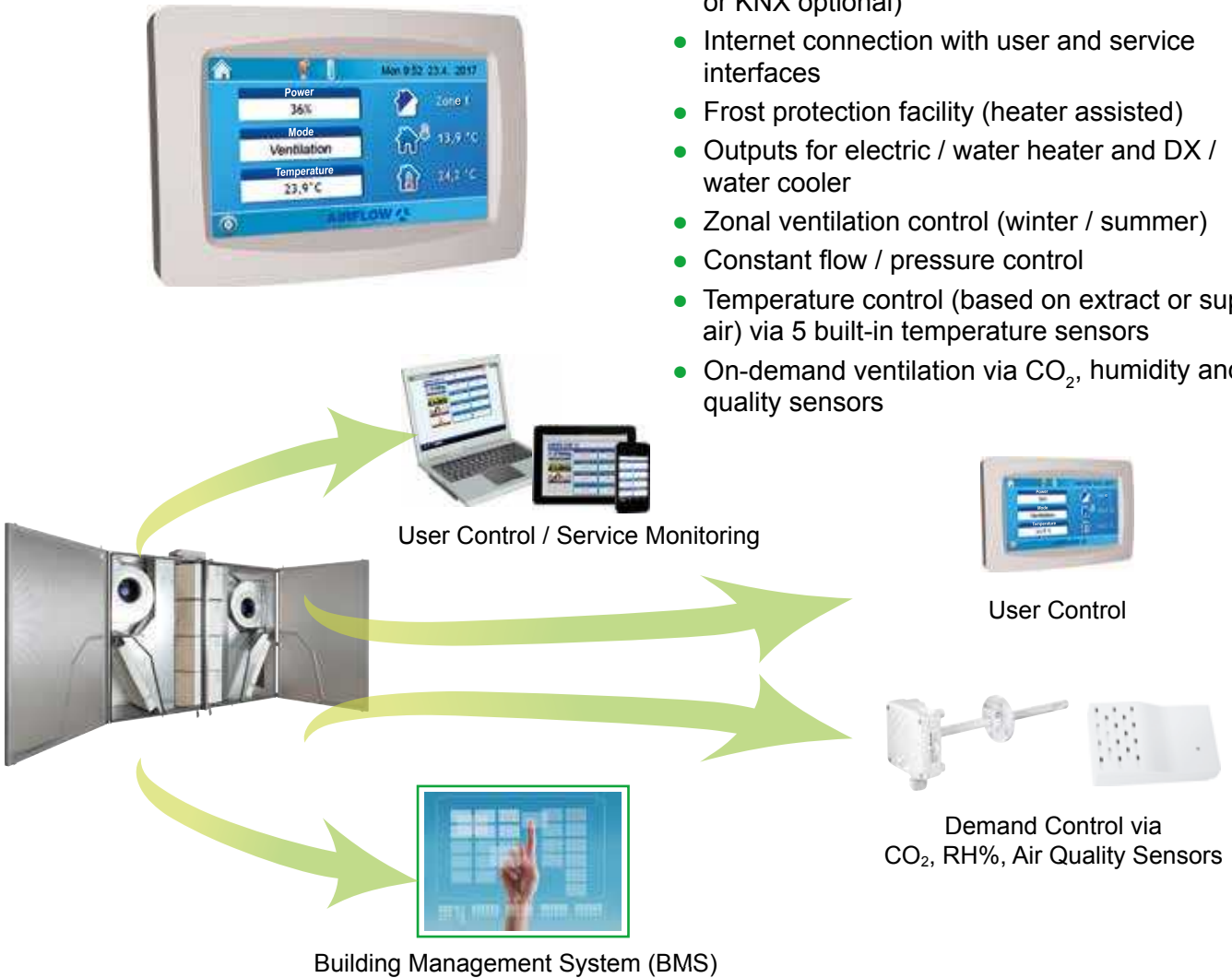

INTERNET CONNECTION

Duplexvent commercial units incorporate an Internet server that uses Modbus TCP/IP protocol to provide a connection between the ventilation unit and the internet via a standard plug and play ethernet cable.

This allows you to monitor and control the unit from a laptop via the internet or a local area network. The unit can also be monitored remotely by technical service which saves time and cost on service processes.



Duplexvent - Selection Software



AHUs Selection Software



Visit: airflow.com/selection-software

Our advanced and user friendly Duplexvent Selection Software makes it possible to select the most suitable product in just a few simple steps.

This freely available online software* gives a quick survey of the right choice of product and easy access to relevant technical information.

After choosing the unit and accessories, you can select the exact specification for your project.

Technical specifications, air flow performance graphs, energy calculations, sound data and dimension drawings are all produced using the software.

QUICK AND EASY SELECTION

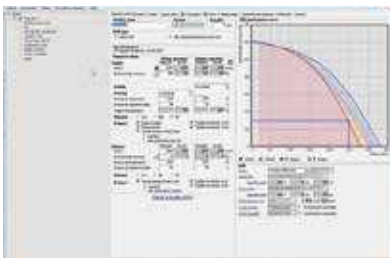

Operation:

- Input of technical parameters such as air volume, static pressure, temperature etc.
- Input of unit functions such as heating, cooling, air circulation, bypass etc.
- Automatic selection of the suitable ventilation unit



Software Outputs:

- Complete technical documentation including air path and h-x diagrams
- Specification of the selected units and components with part numbers and prices



Unit Construction:

- Selection of unit configuration and spigot positions for the specified installation
- Detailed dimensions of the ventilation unit including the spigot size and maintenance space



- Electrical wiring diagram with detailed information about supply voltage, rated current of the fans, fuses, cable connections etc.
- Data can be exported as doc, pdf or dxf (Autocad) format
- Product catalogue pages

*The selection software, which is updated every 6 months, can be found at airflow.com/mvhr-duplexvent-software

CLEAN AIR THINKING



Indoor environment air quality



Ventilation with Heat Recovery

Susurro

Susurro decentralised heat recovery units are ideal for installation in classrooms and offices and improving the indoor air quality of the occupied space whilst reducing the energy consumption of the room. These units use highly efficient heat exchangers to recover up to 90% of the heat that would otherwise be lost and return it to the room.

Thanks to their virtually inaudible operation and excellent ventilation characteristics, all units

in the Susurro range fully comply with BB93 and BB101 for both new-build and refurbished schoolrooms. By complying with BB93 and BB101, Susurro sets the standard in providing an indoor air environment that improves concentration and the occupant's health.

SUSURRO AND SUSURRO DEZAJNO

Susurro is a range of high-quality decentralised heat recovery units that meet the requirements of modern schools and offices. These high quality units, thanks to its extremely efficient heat exchanger and air filtration system, reduce the energy consumption and improve the indoor air quality in the rooms in which they are installed.

Susurro units benefit from advanced electronics technology and high-quality components while Susurro Dezajno model achieves identical performance having the following extra advantages such as angled supply air grille for an enhanced Coanda effect, finished-look side panels and minimalist design.

All units can automatically adjust to changes in occupancy and ventilation demands thanks to its integral CO₂ sensor. The sensor found in the Susurro can detect CO₂ levels from only 370 ppm and enables the Susurro to automatically increase its ventilation rate when CO₂ levels rise due to increased occupancy or room usage.

The compact design and low installation height of all Susurro units allows building managers and architects to maximise

space within the room. Furthermore, the tubular outlet of the unit ensures optimal air flow at all times.

Additional benefits of the Susurro include quiet and low energy Electronically Commutated (EC) fans, integration with Building Management Systems through the Modbus and built-in frost protection and automatic, 100% summer bypass facilities. The unit's performance can be further enhanced thanks to the availability of optional electric pre- and post-heaters.

Servicing is made easier, as important unit information can be easily downloaded on to a compatible mobile device thanks to Susurro's Near Field Communication (NFC) facility.

With the digital touchscreen controller, Susurro can be quickly tailored to suit the specific needs of the user. Weekly and Monthly scheduling can be set with a few taps, guaranteeing that the air quality remains fresh at all times when it is occupied whilst lowering the flow rate of the unit when the room is not in use.

Susurro

Ceiling mounted heat recovery unit for classrooms, offices and conference rooms



INDOOR ENVIRONMENT AIR QUALITY

Clean fresh air is vital for our wellbeing at home, school or work. However, it is not easy to ensure sufficient and effective ventilation. Ideally, the air in the rooms occupied should be exchanged every 2 hours.

Over 65% of those interviewed as part of a BESA study, stated that opening a window is their main form of ventilation. However, opening a window by particularly busy roads simply floods the room of toxic gases and noise which will affect the health, concentration and well-being of those inside.

INDOOR ENVIRONMENT QUALITY

Did you know that people spend 90% of their lives indoors? This fact has an immense impact on our health and wellbeing. There are many indoor effects that adversely affect us, above all: temperature, humidity, CO₂ level and inadequate ventilation.

NEGATIVE EFFECTS OF STAYING IN POORLY VENTILATED AREAS:

- Fatigue
- Headache
- Poor concentration
- Allergies
- Compromised immune system

Effects of CO₂ on the human body

Approx. 350 ppm	Comparable to outdoor environment
Up to 1,000 ppm	Recommended optimum indoor CO ₂ level
1,200-1,500 ppm	Recommended maximum indoor CO ₂ level
1,000-2,000 ppm	Onset of the symptoms of fatigue and lower concentration
2,000-5,000 ppm	Possible onset of headache
5,000 ppm	Max. safe concentration without health hazards
> 5,000 ppm	Nausea and increased pulse rate
> 15,000 ppm	Breathing difficulties
> 40,000 ppm	Possible loss of consciousness

SCHOOL INDOOR AIR QUALITY

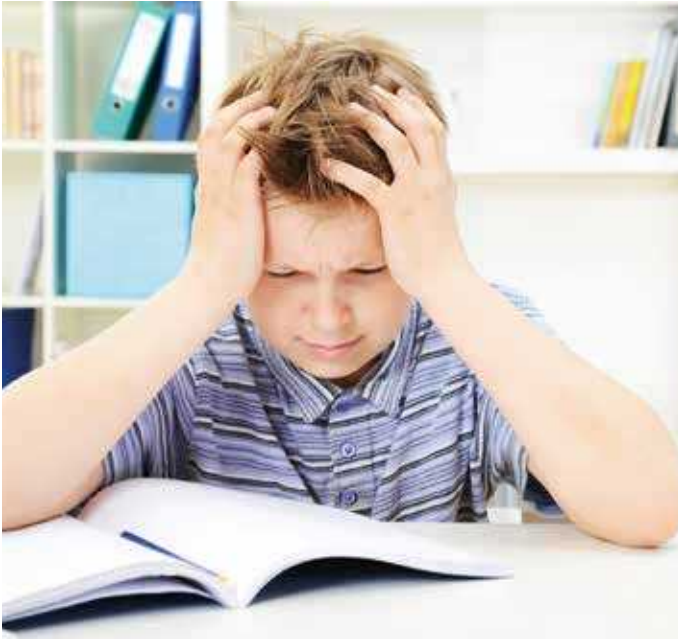

Indoor air quality has been found to negatively impact concentration and productivity levels within offices and classrooms. This issue is a particular problem in the UK, as 1000's of schools are situated in areas with illegal air pollution levels.

Children stay in classrooms for long periods of time, however classrooms often have insufficient ventilation that negatively impacts the child's concentration levels and ability to learn. In order to combat air pollution in schools, the government introduced Building Bulletin 101(BB101): Guidelines on Ventilation, Thermal Comfort and Indoor Air Quality in Schools.

INDOOR ENVIRONMENT QUALITY

Did you know that it can be difficult to concentrate in a stuffy classroom? But in a properly ventilated classroom, children work faster and are better at solving tasks.

If you want to do better on an exam it's well worth getting some fresh air into the classroom first!

NEGATIVE EFFECTS OF INSUFFICIENT FRESH AIR IN CLASSROOMS:

- Fatigue
- Poor concentration
- Compromised ability to perceive new information
- Demotivation of children

CO₂ concentrations measured during lessons

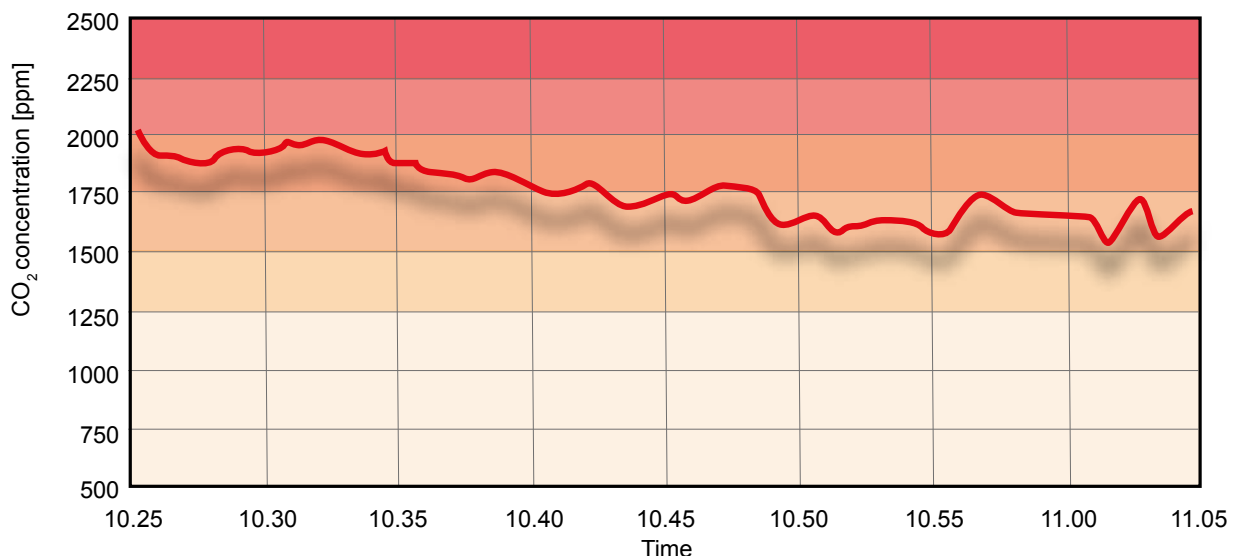

Total air volume: 250 m³
Pupils in classroom: 30

Windows: tripled glass
Indoor temperature: 22.3 °C

Outdoor temperature: 27 °C,
sunny weather

Windows were closed. Ventilation
was ensured by opening doors.

Susurro

Ceiling mounted heat recovery unit for classrooms, offices and conference rooms

TYPICAL APPLICATIONS

Susurro is the ideal unit for educational and professional premises including:



- **Classrooms & Special Educational Needs Facilities**

Ensure an indoor air environment that aids learning



- **Nurseries**
Protect the health of young children



- **Offices**
Promote productivity within the workplace with fresh, filtered indoor air



- **Dining Rooms**
Prevent the build-up of damp and mould



- **Lecture Theatres**
Improving the air without distractions



- **Waiting rooms**
Provide a comfortable indoor air environment



- **Libraries**
Aid concentration with discrete ventilation



- **Sports Halls**
Enjoy temperate, healthy indoor air at all times



- **Seminar Rooms**
Offering the ideal air environment for learning and discussion



- **Board Rooms**
Fresh air gives you the ideal environment to make business decisions

Susurro

Heat Recovery Ventilation

MODELS AVAILABLE

Susurro range includes two casing designs: **Susurro** and **Susurro Dezajno** with a stylish supply air grille and concealed fixings. The advanced electronics technology and high-quality components are identical in both models available.

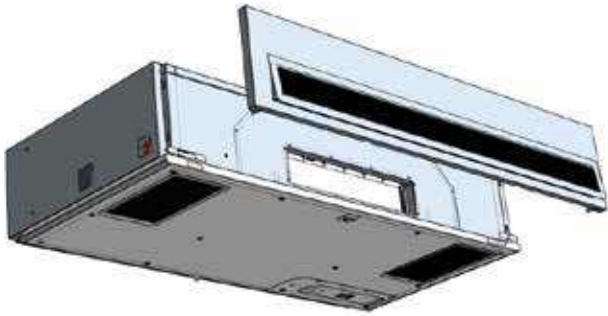

- The same grille opening for both versions
- Angled supply air grille, so the air flow is directed slightly upwards for a greater Coanda effect
- Finished-look side panels
- Minimalist design with honeycomb stylish elements for a laminar air flow

The Susurro decentralised ventilation units with heat recovery offer the ideal solution for different requirements – both in new and existing buildings. The compact design and simple installation without an air distribution system also prove that Susurro is the perfect ventilation unit for renovation projects.

Two models available (Susurro and Susurro Dezajno),

Three unit sizes available for air flow rates up to 400, 700 and 1000 m³/h (111, 194 and 278 l/s)

One standard configuration available for each size unit (no pre-heater or post-heater coils)

Seven different configurations available for each size unit:

1. Unit equipped with electric post-heater
2. Unit equipped with water post-heater
3. Unit equipped with change-over (C/O) 3-row coil post-heater (for heating and cooling)
4. Unit equipped with electric pre-heater
5. Unit equipped with electric pre-heater and electric post-heater
6. Unit equipped with electric pre-heater and water post-heater
7. Unit equipped with electric pre-heater and change-over (C/O) 3-row coil post-heater (for heating and cooling)

Susurro



Susurro Dezajno



Susurro

Heat Recovery Ventilation

KEY COMPONENTS

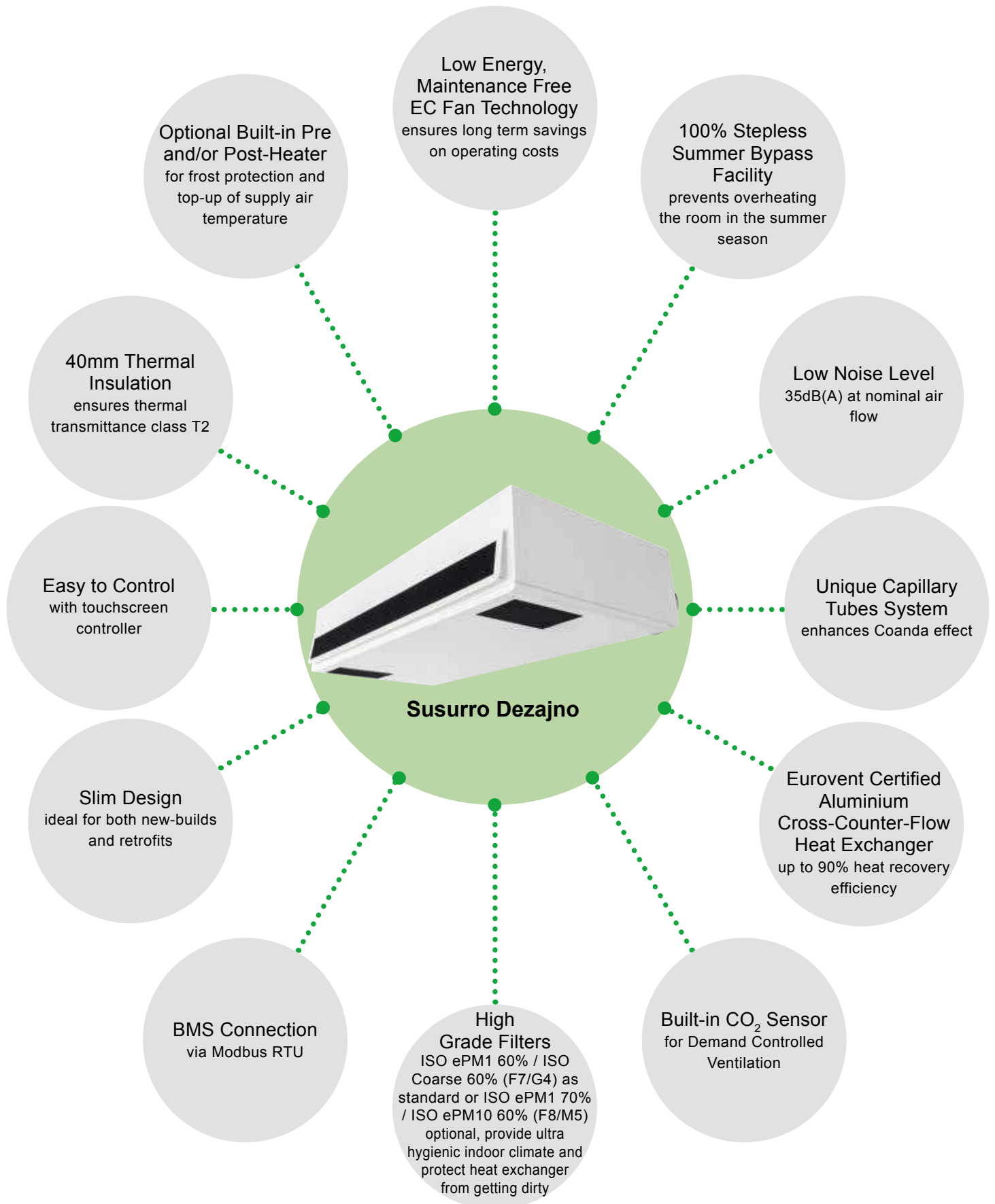

Susurro

Ceiling mounted heat recovery unit for classrooms, offices and conference rooms



BENEFITS OF THE CO₂ SENSOR

The Susurro's integral CO₂ sensor actively monitors the indoor air quality inside the room or office and enables Susurro to automatically adjust its ventilation based on occupant demand; maintaining a healthy, fresh indoor air environment without the occupants having to open a window.

By maintaining healthy CO₂ levels, Susurro improves concentration and productivity levels of students and employees, lowers occupant fatigue, decreases the risk of long-term health issues and reduces the number of days lost due to illness.

WHY IS INDOOR AIR QUALITY (IAQ) IMPORTANT?

The UK has the highest rate of asthma sufferers in Europe and the effects are worsened due to air pollution. The air pollution in the UK is so bad, that the UK government has been repeatedly taken to court over its failure to properly address the issue. But the issue isn't restricted to busy cities and industrial areas.

We spend up to 90% of our time indoors but indoor air pollution can be up to 50 times worse than outdoors and

can contain up to 900 different chemicals and pollutants.

Indoor air pollution can cause and worsen respiratory issues such as lung cancer, heart disease and even cause strokes. Ensuring adequate ventilation takes place within the built environment is one of the methods to minimise the health risks of indoor air pollution.

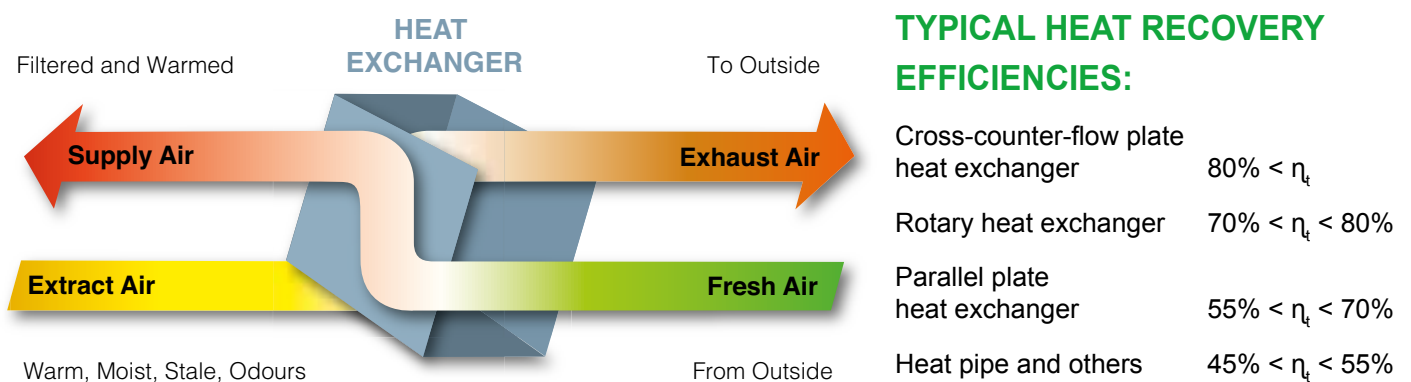

TYPICAL HEAT RECOVERY EFFICIENCIES:

Cross-counter-flow plate heat exchanger	80% < η_t
Rotary heat exchanger	70% < η_t < 80%
Parallel plate heat exchanger	55% < η_t < 70%
Heat pipe and others	45% < η_t < 55%

CROSS-COUNTER-FLOW HEAT EXCHANGER

Susurro use highly efficient cross-counter-flow heat exchangers to recover up to 90% of the heat from the extracted air. Susurro heat exchangers are tested in accordance with EN308 standards and have Eurovent certification.



Incoming fresh air is warmed by the heat from the extract air in the heat exchanger. However, the two air streams do not mix. Cross-counter-flow heat exchangers achieve the highest thermal efficiency thanks to their increased surface area. This helps to reduce heating bills and accelerates return on the investment.

COANDA EFFECT

The Coanda effect occurs when the fresh inlet air runs along the ceiling before slowly descending into the room.

The Coanda effect causes the incoming air stream to stick to the ceiling. The incoming air is supplied at a high velocity into the room; ensuring effective mixing of the incoming air and the ambient room air. Mixing the ambient air with the supplied air ensures high quality air throughout the room. The result of the Coanda effect is a draught-free zone below ceiling height.

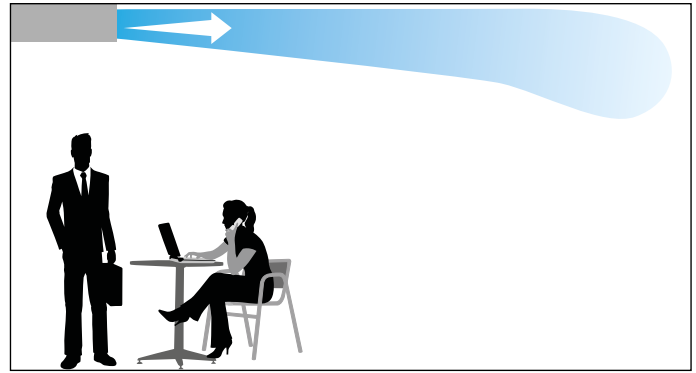

The ceiling-mounted units all ventilate using the mixing principle where fresh air is supplied into the room near the ceiling using the Coanda effect.

NOISE

Modern life has become loud, with people bombarded with noise on an almost constant basis from a variety of sources. Excessive noise impacts concentration levels, reduces productivity and affects your hearing.

To ensure that schools maintain an environment that encourages learning and helps students concentrate, a Building Bulletin was introduced. Building Bulletin 93 (BB93): Acoustic Design of Schools – Performance Standards lays out the acoustic criteria that appliances used in schools, including ventilation units, must adhere to.

Ventilation units in new build properties must not be louder than 35 dB(A) during normal periods and no louder than 40 dB(A) during summer bypass or boost modes in classrooms. Susurro meets this criteria for both new builds and refurbishments, with a virtually inaudible every day running rate of 35 dB(A); creating a healthy indoor air environment that aids concentration in lessons.

The Susurro also meets the sound criteria for rooms used for students with Special Educational Needs (SEN) outlined in BB93.

EC MOTORS

Susurro units are fitted with low energy, low maintenance Electronically Commutated (EC) fans. An EC fan is a brushless DC motor with intelligent integrated control, which enables the fan speed to be kept at the optimal level, ensuring maximum fan efficiency at all times.

Other advantages of EC fans are:

- Increased reliability and lifetime of the motor - reducing service costs
- Low power consumption reduces operating costs
- Stepless for easier control
- Low SFP values
- Silent operation
- More compact compared to an AC motor



Susurro

Ceiling mounted heat recovery unit for classrooms, offices and conference rooms

CORRECT PLACING

To get the full benefits, Susurro must be located according to the physical geometry of the room.

1

Two smaller units can be appropriate for a long, narrow room, where the throw length is too short longitudinally, yet too long laterally.

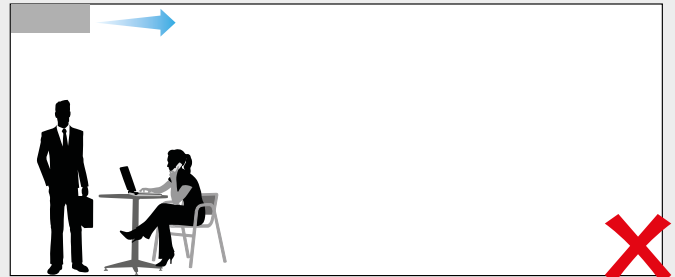
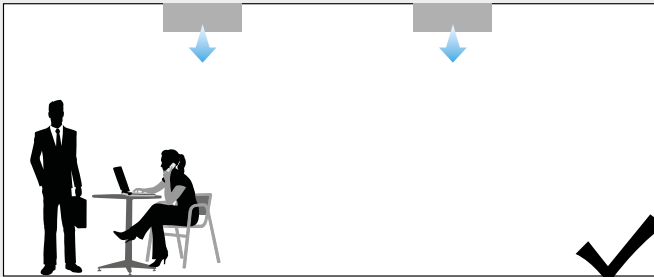

2

In a room with high or sloping ceilings, the units should be installed as high up as possible

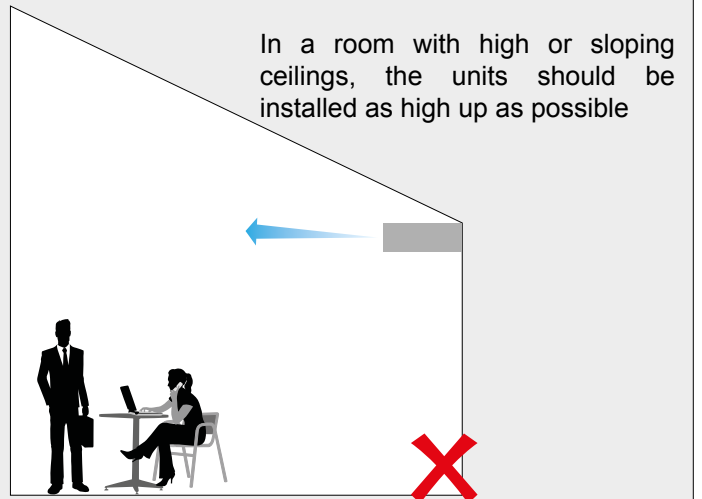
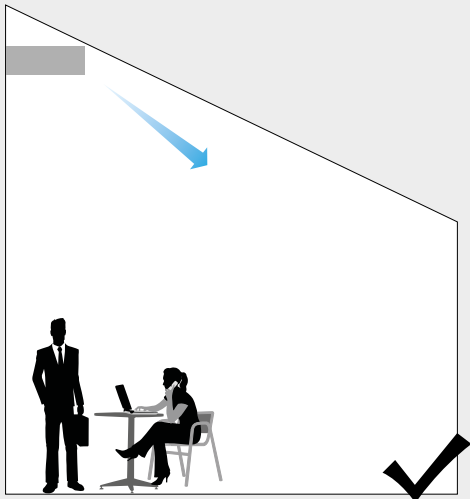

3

To achieve the most efficient supply conditions, objects, such as light fittings installed directly in the ceiling, should be avoided. Light fittings should be lowered so that the inlet has free access to the room.

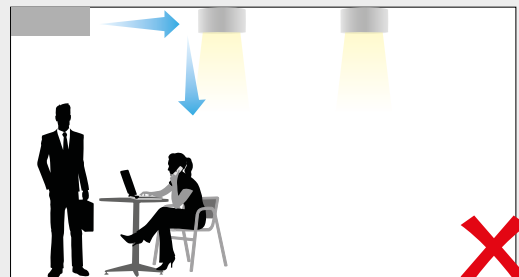
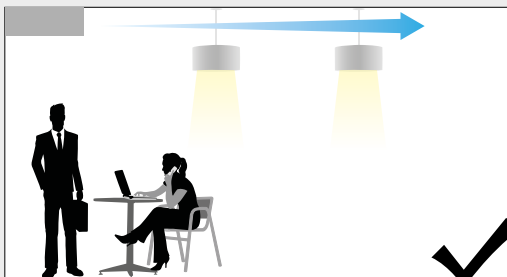

AIR FILTERS

Susurro are fitted with Coarse 60% (G4) and ePM1 60% (F7) air filters as standard. The ePM1 60% (F7) filter is fitted on the supply side of the unit before the air can enter the heat recovery core. The ePM1 60% (F7) filter prevents particulate matter as small as black carbon, typically created from diesel exhausts, from entering the built environment; protecting the health and well-being of the occupants inside and the long-term health of the unit.

A Coarse 60% (G4) filter is fitted at the extract side of the unit before the air can enter the heat exchanger. This type of filter prevents larger debris such as carpet fibres, hair and insects from entering and damaging the unit.

Susurro have the option to be fitted with ePM10 60% (M5) and ePM1 70% (F8) air filters. M5 ePM10 60% (M5) filters are beneficial where cement particles are present in the air. F8 ePM1 70% (F8) air filters are similar to an ePM1 60% (F7) filter but protect the occupants by preventing smoke, such as tobacco and oil, from entering the dwelling via the ventilation system. These filters are ideal for buildings that are situated near busy industrial areas or experience a lot of commercial traffic.

INDOOR AIR QUALITY IN SCHOOLS



The UK government introduced Building Bulletin 101 (BB101): Guidelines on Ventilation, Thermal Comfort and Indoor Air Quality in Schools to ensure that when schools are built and renovated, they provide a healthy indoor air environment for students. The document sets out regulations, standards and guidance on ventilation, thermal comfort and indoor air quality for school buildings.

The guidelines provide an introduction and describe the factors that affect the design of the indoor environment of schools (Section 1). Section 2 describes the regulatory framework for schools. It gives the recommended DfE performance standards for compliance with UK regulations. Section 3 provides a summary of regulations and recommended performance standards for school designers. Sections 4 to 5 provide detailed non-statutory guidance on how to design schools to achieve adequate performance for ventilation, indoor air quality and thermal comfort.

SUMMER BYPASS

All Mechanical Ventilation with Heat Recovery Systems must come with a bypass facility in order to comply with the ErP Ecodesign Directive. Bypass facilities in MVHR units are used to minimise overheating within the built environment and work by preventing heat recovery taking when the air temperature is too high.

Susurro uses an automatic, 100% summer bypass facility to prevent heat recovery from taking place during the hot summer months; minimising overheating within the classroom or office.

An automatic, 100% bypass facility works by isolating the heat exchanger by the use of a flap, which prevents the supply air reaching the heat exchanger. The supply air instead bypasses the heat exchanger and is merely filtered before entering the occupied area.

By utilising a 100% summer bypass, Susurro prevents unnecessary heat recovery taking place and risk of overheating.

Susurro

Ceiling mounted heat recovery unit for classrooms, offices and conference rooms

DECENTRALISED VENTILATION

An optimum indoor environment can be maintained through decentralised ventilation when supply air and exhaust air are managed with a suitable heat recovery unit.

VENTILATE INDIVIDUAL ROOMS AS NECESSARY

- Suitable for providing ventilation in a single larger room (classroom, meeting room, open office)
- The system can be installed in existing buildings without having to design a detailed ventilation system
- No air ducts
- High flexibility

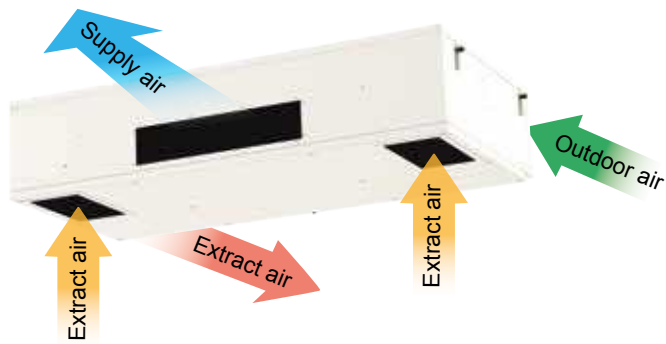

DECENTRALISED VENTILATION WITH HEAT RECOVERY UNIT

The Susurro heat recovery unit is designed for decentralised ventilation. It provides an ideal solution in both new and existing buildings. Its minimum noise level makes it a perfect choice for schools, offices and conference rooms.

- 3 sizes with air flow rates of **400, 700 and 1,000 m³/h**
- High heat recovery efficiency up to **90%**
- Ultra-quiet operation – **35 dB(A)**
- Integrated **CO₂ sensor**
- Energy-efficient **EC motors**



DECENTRALISED VENTILATION	Advantage +
Only openings in the perimeter wall are required for ducts	+
Heat recovery efficiency	= 90%
Minimum cost of assembly; suitable for existing buildings	+
Easy access by maintenance staff	+

FIRST CLASS CHOICE:

- Continuous supply of fresh air
- Optimum CO₂ levels
- Minimum noise level
- High heat recovery efficiency up to **90%**
- Energy saving
- Helps people with allergies and breathing difficulties
- Prevention of mould
- Prevention of fatigue and headaches that are caused by CO₂
- Elimination of outside noise due to open windows
- Suitable even for older buildings
- Easy to install
- NFC technology
- Complies with BB101 2017- Guidelines on ventilation, thermal comfort and indoor air quality in schools

The Susurro units by Airflow feature a new generation of efficient, energy-saving and ultra quiet technologies that ensure the highest quality of indoor environments and are ideal for classrooms and offices.



Susurro

Ceiling mounted heat recovery unit for classrooms, offices and conference rooms



KEY FEATURES

Decentralised heat recovery ventilation

- Two versions available: Susurro and Susurro Dezajno
- Compliant with BB101 2017 and BB93 2015
- NFC technology
- Up to 90% heat recovery efficiency
- Low energy EC fans
- Low noise level (35dB (A) at nominal air flow)
- Excellent thermal insulation (thermal transmittance class T2)
- Automatic 100% bypass
- Built-in CO₂ sensor
- Optional built-in pre or post heater
- Tubular system for optimal laminar air flow
- Slim design with low installation height for efficient space usage
- Digital touch-screen controller
- 3 year warranty

SUSURRO

The Susurro are highly efficient MVHR units designed for classroom and office use. They have an ambient temperature range of +5°C up to 40°C and provide fresh, healthy air, free from dust, chemicals and other pollutants to the occupied room. If the outdoor air temperature drops below freezing, the unit's optional pre-heater activates to warm the incoming air in order to prevent damage to the heat exchanger.

Susurro offers completely automated controls, which optimise the unit's operation in order to achieve maximum energy efficiency and minimal heat losses. It is important to ensure that the design and installation of any ventilation system using Susurro is carried out by a competent HVAC designer and installer.

The Susurro Dezajno models offer an aesthetically pleasing design and due to their unique tubular outlet, they further enhance the Coanda effect of the unit.

1	Tubular outlet
2	Main switch
3	Outside fresh air duct with spring loaded damper
4	Outside exhaust air duct with spring loaded damper
5	Tubular inlet
6	Condensate drain

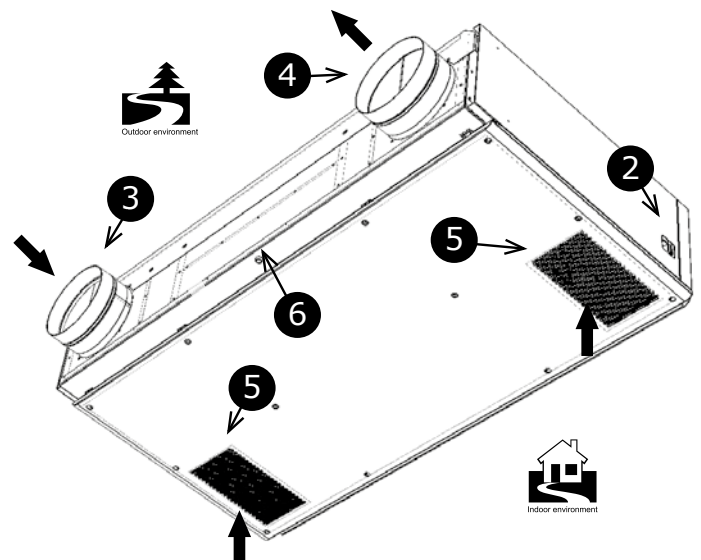
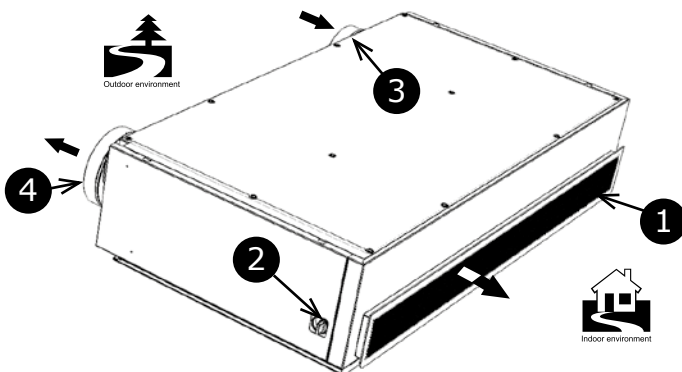

OPERATIONAL DIAGRAM

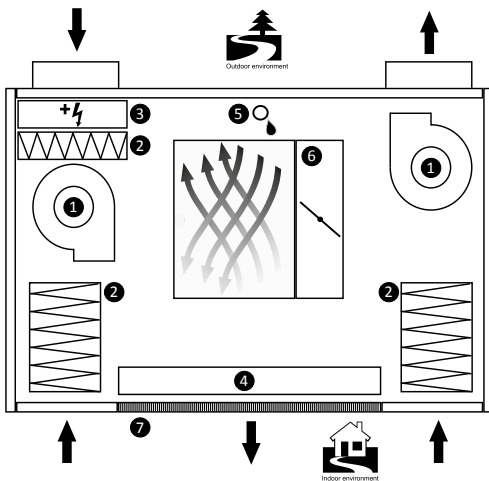

1	Fan
2	Filter
3	Preheater (optional)
4	Afterheater (optional)
5	Condensate drain
6	Heat exchanger with by-pass damper
7	Tubular outlet

PERFORMANCE TABLE

Duplexvent Susurro		400	700	1000
Max air flow at 0Pa	m ³ /h / l/s	500 / 139	850 / 236	1200 / 333
Heat recovery efficiency ¹	%	Up to 90	Up to 90	Up to 85
Fan type		EC		
Summer bypass		100% automatic		
Integral CO ₂ sensor	ppm	370 - 2000	370 - 2000	370 - 2000
Connection to BMS		Modbus RTU		
Sound pressure level at 3m ²	dB(A)	25.8	26.1	26.4
Spigot diameter	mm	250	315	315
Condensate discharge	mm	22		
Electrical supply		230V / 1ph / 50Hz		
Casing insulation	mm	40		
Filter class - ISO 16890 compliant		ePM1 60% (F7) at supply, Coarse 60% (G4) at extract		
Weight ³	kg	92	126	149
Max power input	kW	0.34	0.70	0.70
Heating output of built-in electric pre-heater (optional)	kW	1.50	2.00	3.00
Heating output of built-in electric post-heater (optional)	kW	1.50	2.25	3.00
Heating output of built-in water post-heater (optional) ⁴	kW	4.61	6.56	9.40
Part No:		90000915*	90000921*	90000927*

1. According to air volume
 2. For working points: Susurro 400
 - 415m³/h at 0Pa, Susurro 700
 - 747m³/h at 0Pa, Susurro 1000
 - 1018m³/h at 0Pa
 3. Depending on equipment
 4. For water temperature 90/70°C
 and inlet air temperature 10°C
 *These units are standard; however,
 they can be customised according to
 certain requirements (e.g. with electric
 preheater, with electric postheater,
 with water postheater, with electric pre
 and postheater, with electric preheater
 and water postheater etc.)

DIMENSIONS

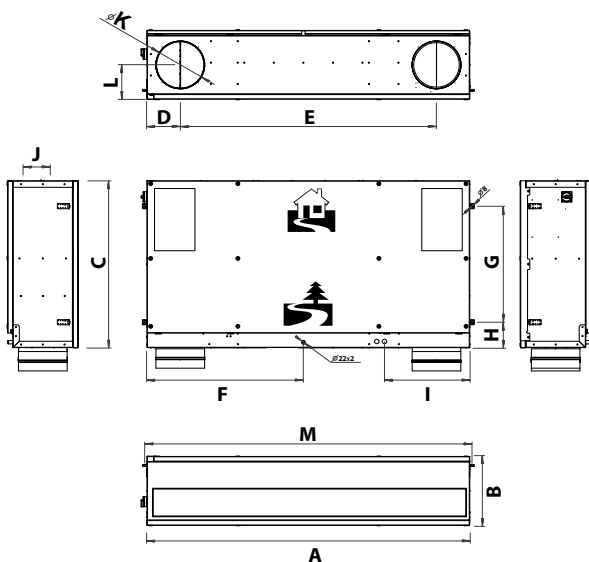

Susurro		A	B	C	D	E	F	G
Susurro 400	mm	1806	397	942	183	1408	875	689
Susurro 700	mm	2076	452	1098	212	1648	1006	763
Susurro 1000	mm	2406	573	1263	241	1920	1203	962

Susurro		H	I	J	K	L	M
Susurro 400	mm	108	503	144	250	197	1835
Susurro 700	mm	167	548	146	315	228	2105
Susurro 1000	mm	150	604	140	315	287	2435

Susurro Dezajno		A	B	C	D	E	F	G
Susurro 400	mm	1870	394	965	214	1408	908	689
Susurro 700	mm	2141	455	1116	247	1648	1039	763
Susurro 1000	mm	2470	575	1281	275	1920	1235	962

Susurro Dezajno		H	I	J	K	L	M
Susurro 400	mm	165	535	177	250	197	1835
Susurro 700	mm	185	581	224	315	228	2105
Susurro 1000	mm	150	637	224	315	287	2435

Susurro

Ceiling mounted heat recovery unit for classrooms, offices and conference rooms

PERFORMANCE

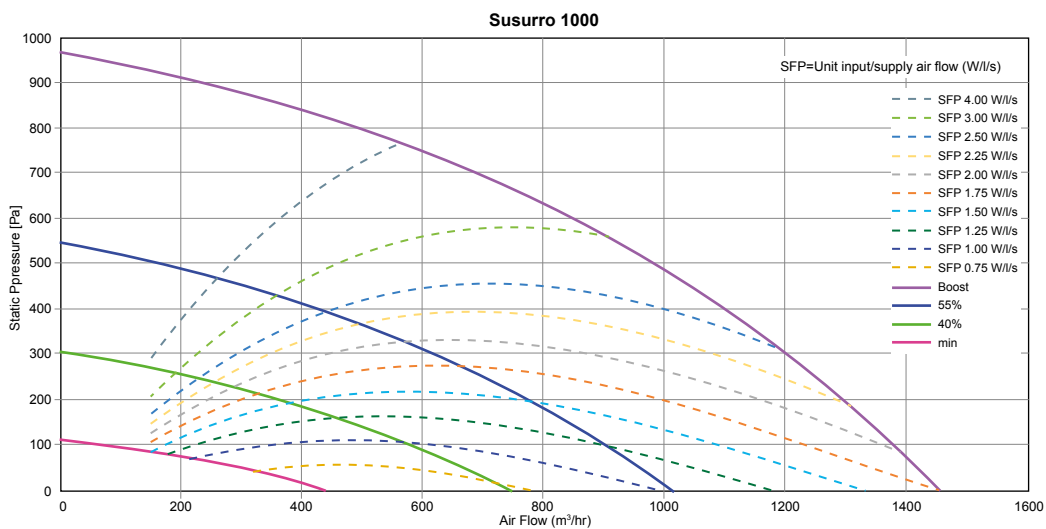
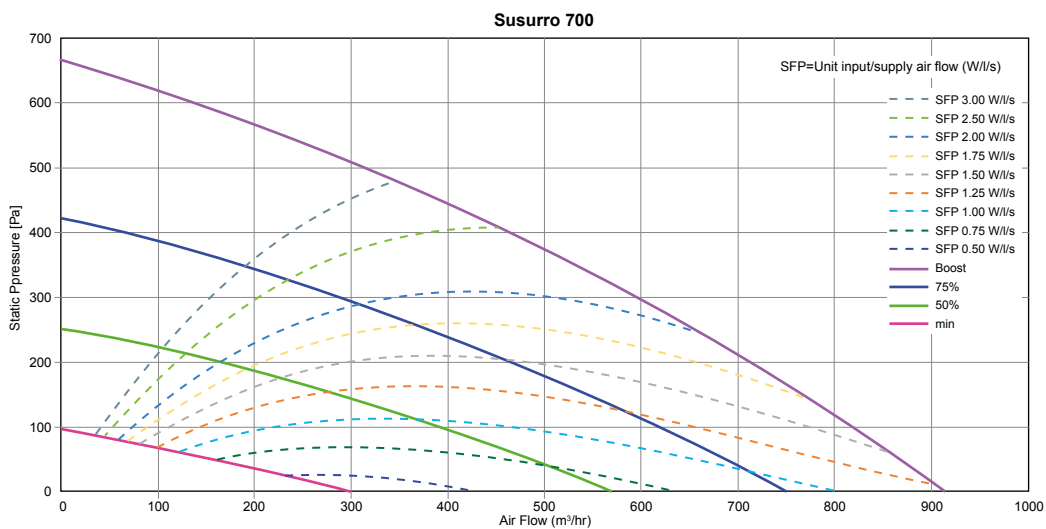
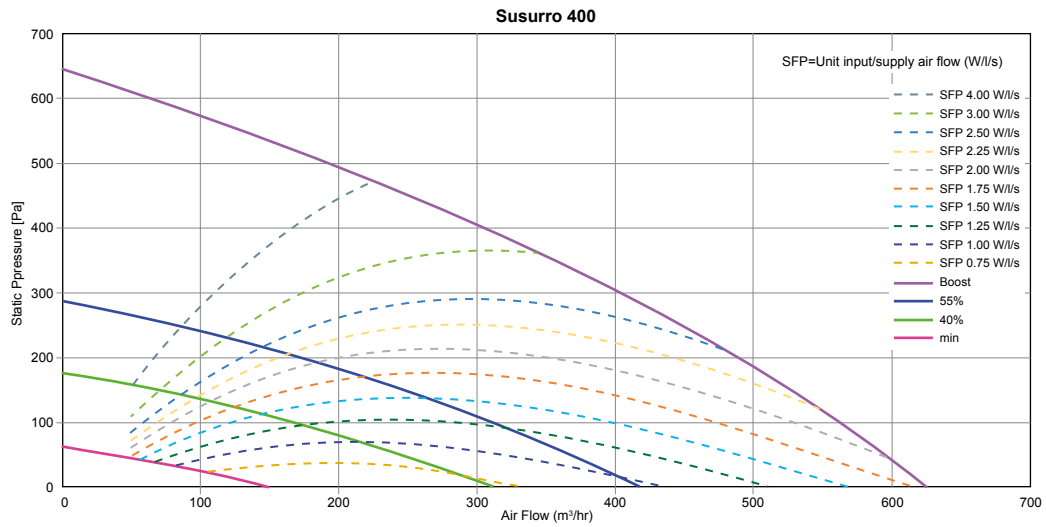

THERMAL EFFICIENCY

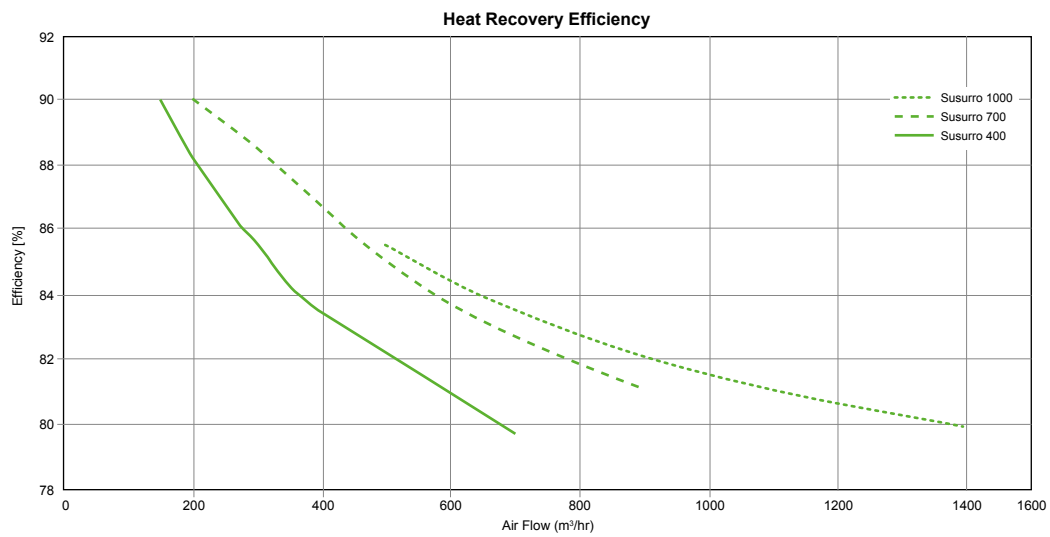

ROOM CAPABILITY (COANDA EFFECT)

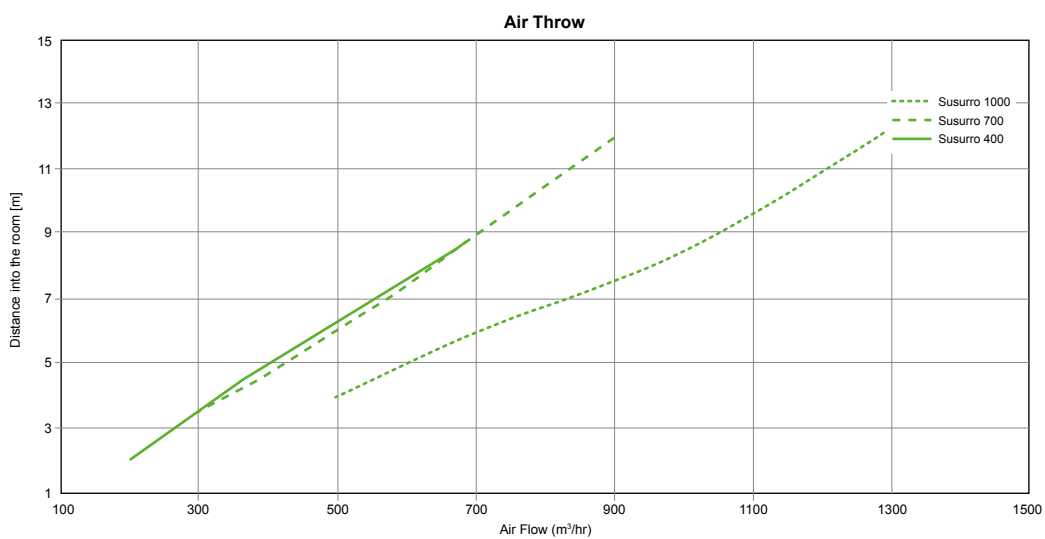

Susurro

Ceiling mounted heat recovery unit for classrooms, offices and conference rooms

ELECTRICAL PARAMETERS OF THE UNITS

Model	Phase	Voltage	Frequency	Rated Input	Total Current	Weight
	Ph	V	Hz	W	A	kg
Standard Models						
Susurro 400	1	230	50	340	2.70	92
Susurro 700	1	230	50	340	2.70	126
Susurro 1000	1	230	50	700	5.00	149
With Electric Pre-Heater Only						
Susurro 400 EPRH	1	230	50	1840	9.22	93
Susurro 700 EPRH	1	230	50	2340	11.40	127
Susurro 1000 EPRH	3	400	50	3770	7.50	150
With Electric Post-Heater Only						
Susurro 400 EPOH	1	230	50	1840	9.22	93
Susurro 700 EPOH	1	230	50	2590	12.48	127
Susurro 1000 EPOH	3	400	50	3770	9.33	150
With Water Post-Heater Only						
Susurro 400 WPOH	1	230	50	340	2.70	93
Susurro 700 WPOH	1	230	50	340	2.70	127
Susurro 1000 WPOH	1	230	50	700	5.00	150
With Electric Pre and Post Heater						
Susurro 400 EPRH-EPOH	1	230	50	3340	15.74	94
Susurro 700 EPRH-EPOH	3	400	50	4590	9.78	128
Susurro 1000 EPRH-EPOH	3	400	50	6770	11.83	151
With Electric Pre-Heater and Water Post-Heater						
Susurro 400 EPRH-WPOH	1	230	50	1840	9.22	94
Susurro 700 EPRH-WPOH	1	230	50	2340	11.40	128
Susurro 1000 EPRH-WPOH	3	400	50	3770	7.50	151

SOUND PARAMETERS

Susurro 400

Fan speed	Pressure [Pa]	Air flow [m³/h]	Sound power level per frequency band								Overall		
			63Hz	125Hz	250Hz	500Hz	1kHz	2kHz	4kHz	8kHz	Sound power L _{WA} [dB]	Sound pressure at 1m L _{PA} [dB]	Sound pressure at 3m L _{PA} [dB]
min	0	169	31.0	37.1	29.2	26.3	26.3	25.5	26.5	25.0	39.6	26.9	17.7
40%	0	316	31.4	39.7	38.2	32.4	30.8	27.1	24.9	24.7	43.2	30.5	21.4
55%	0	415	36.1	43.1	44.0	36.8	34.5	30.1	25.8	25.1	47.7	35.0	25.8
Boost	0	500	41.3	46.7	48.6	40.7	38.0	33.6	27.6	26.0	51.8	39.1	29.9

SOUND PARAMETERS (continued)

Susurro 700

Fan speed	Pressure [Pa]	Air flow [m³/h]	Sound power level per frequency band								Overall		
			63Hz	125Hz	250Hz	500Hz	1kHz	2kHz	4kHz	8kHz	Sound power L _{WA} [dB]	Sound pressure at 1m L _{PA} [dB]	Sound pressure at 3m L _{PA} [dB]
min	0	307	19.1	31.7	35.4	29.7	22.4	21.9	28.1	27.0	38.7	25.4	16.6
50%	0	561	33.9	37.9	36.5	33.1	31.9	29.6	27.4	25.9	42.6	29.4	20.5
75%	0	747	39.2	41.9	43.4	39.1	38.6	36.0	29.0	26.3	48.2	34.9	26.1
Boost	0	850	42.0	45.2	48.5	43.7	42.5	40.0	31.5	27.1	52.3	39.1	30.2

Susurro 1000

Fan speed	Pressure [Pa]	Air flow [m³/h]	Sound power level per frequency band								Overall		
			63Hz	125Hz	250Hz	500Hz	1kHz	2kHz	4kHz	8kHz	Sound power L _{WA} [dB]	Sound pressure at 1m L _{PA} [dB]	Sound pressure at 3m L _{PA} [dB]
min	0	499	24.9	35.6	28.4	25.5	24.5	19.7	12.4	10.5	37.3	23.4	14.9
40%	0	772	29.3	38.9	37.3	34.1	35.6	29.4	23.8	21.6	43.2	29.3	20.9
55%	0	1018	37.2	42.3	43.7	40.2	41.4	36.2	31.3	27.7	48.8	34.9	26.4
Boost	0	1200	43,5	45,5	47,6	44,3	44,5	41,1	36,1	30,3	52,7	39,1	30,4

CHARACTERISTICS OF ELECTRIC PRE-HEATER

Model	Phase	Voltage	Frequency	Rated Input	Total Current
	Ph	V	Hz	W	A
Susurro 400	1	230	50	1500	6.52
Susurro 700	1	230	50	2000	8.70
Susurro 1000	2	400	50	3000	7.50

CHARACTERISTICS OF ELECTRIC POST-HEATER

Model	Phase	Voltage	Frequency	Rated Input	Total Current
	Ph	V	Hz	W	A
Susurro 400	1	230	50	1500	6.52
Susurro 700	1	230	50	2250	9.78
Susurro 1000	3	400	50	3000	4.33

CHARACTERISTICS OF WATER HEATING COIL

Model	Rated Input	Water Pressure Loss	Air Pressure Loss	Water Flow	Connection Diameter
	kW	kPa	Pa	l / sec / m³/h	inches
Susurro 400	4.61	5.59	7.26	0.06 / 0.2	0.5
Susurro 700	6.56	10.3	19.13	0.08 / 0.29	0.5
Susurro 1000	9.40	4.32	14.42	0.11 / 0.41	0.5

For water temperature gradient 90/70°C and inlet air temperature 10°C

Susurro

Ceiling mounted heat recovery unit for classrooms, offices and conference rooms

CONTROLS

Check the status and adjust your Susurro with a few taps from the digital controller



Adjust the flow rate of your Susurro

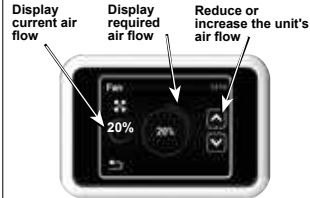

Adjust the required temperature of the room

Display current temperature (at selected sensor) Display required temperature Reduce or increase required temperature



Set the temperature at which the summer bypass activates

Setting the minimum temperature that allows to open the bypass (0-20°C)



Adjust the ventilation rate based on occupancy levels

Set the time interval after which the mode is activated when the PIR sensor is activated (input terminals 15/16)



Setting the required flow

Schedule the unit's ventilation profiles with weekly and annual calendars



Protect the long-term performance of your Susurro with filter change notifications



Download key product information with NFC technology



In the NFC menu you can display the information after placing an NFC compatible mobile device.



TOUCHSCREEN CONTROL PANEL

Susurro's control panel is intuitive and easy to use. The coloured display provides detailed information about unit's operation parameters and enables precise control.



BUILDING AUTOMATION

You can connect Susurro to Building Automation Systems through the Modbus.



CARBON DIOXIDE SENSOR

Susurro units are equipped with a CO₂ sensor as standard, which automates the ventilation process. The ventilation rate is automatically increased when the carbon dioxide levels rise. This helps to maintain an oxygen rich, healthy indoor air environment even if the room is full of people.



ADDITIONAL SENSORS

Susurro units can be also equipped with an optional external humidity, motion or air quality sensors to enable fan speed control based on relative humidity, occupancy or air pollutants level.



HEATERS

Optional electric pre/post-heaters and water post-heaters can be equipped to Susurro to top up the supply air temperature and protect the unit's heat exchanger from frost.



ADDITIONAL SWITCHES

You can use external switches to control Susurro. For example, you can use a switch to manually boost the level of ventilation when required.

Susurro has a Near-Field Communication (NFC) facility that enables the user, by holding a compatible smartphone near the unit, to download the product datasheet and directly contact Airflow when undertaking maintenance of the unit.



Susurro

Ceiling mounted heat recovery unit for classrooms, offices and conference rooms

CONTROLS

The Susurro advanced operating system is intuitive and easily operated via freely definably air volume ensuring excellent air quality. The ventilation is demand-controlled and continuously variable via sensors or different weekly and daily programmes. The modern LCD touchscreen controller has a clear large display and user-friendly controls for the individual operations and thorough information on all operating statuses and ventilation modes.

This control system benefits from a number of functions available, such as e.g. timer, bypass control, night cooling, basic ventilation, CO₂ or RH - humidity-dependent air volume control and it is also building automation system-compatible and thus optimally ready for smart ventilation control.

SUSURRO CONTROLS MAIN BENEFITS:



FREE-COOLING MODE

Night cooling ventilation is ideal in the hot summer months. If this mode is active and all selected conditions are met, this results in the complete opening of the summer bypass for directing cooler air into the room (heat recovery process does not take place).



POST-HEATING

The optional integrated electrical or water post-heating coils ensure that the supply air is at a comfortable requested temperature when it flows into the room, even at negative temperatures. This feature provides a relaxing feel-good climate, even during the coldest winters.



BOOST FUNCTION

Susurro units run at maximum fan speed for a pre-set period.



OCCUPANCY MODE

This mode works the same as a time delay function to ensure that the units continue to operate for a pre-set period after people have left the room. Setting the time interval for which the mode will be active after the PIR sensor is activated in the 1-60 minutes range.



Main control functions

Touch control
Stepless fans (0-10V)
Stepless afterheating (internal electrical)
Stepless automatic regulation of preheating
Integrated timer (daily, weekly)
Optional connection of sensors: CO ₂ , RH, VOC (0-10V)
Stepless Bypass (temperature control: free cooling, antifreeze protection)
Offset fan adjustment (over-pressure and under-pressure)
Indication of filter clogging
CAV (Constant Air Volume) and DCV (Demand Controlled Ventilation) ventilation modes available
BOOST function - intensive air flow at maximum power for a set period
Freecooling functions - night ventilation (cooling)
Occupancy function - reducing ventilation according to the PIR sensor
BMS - connection via Modbus RTU / TCP, BACnet

Susurro

Continuous development and improvement

Susurro Dezajno



As an option, the Susurro range is available with a built-in electric preheater; electric, water or change-over (C/O) 3-row water coil post heater.

The change-over (C/O) 3-row coil power for heating and cooling can be seen in the following table.

Unit s size	Heating power	Cooling power
Susurro 400	4.17	2.88
Susurro 700	6.26	4.26
Susurro 1000	8.74	5.73

The change-over 3-row coil is a cooling coil using cold water, which can also be used as a heating coil by increasing the water temperature according to the demand temperature. The change-over working principle is to switch the demand supply between hot and chilled water transferring this energy into the air stream using the unit. Therefore, it improves the temperature control and facilitates the heat recovery unit to switch between higher or lower supply temperatures.

CHARACTERISTICS OF CHANGE-OVER COIL (C/O)

For water temperature gradient 60/40 and inlet air temperature 10°C



Model	Rated Input	Water Pressure Loss	Air Pressure Loss	Water Flow	Connection Diameter
	kW	kPa	Pa	l/sec / m³/h	inches
Susurro 400	4.28	0.49	19	0.05 / 0.19	0.75
Susurro 700	6.41	0.98	49	0.07 / 0.28	0.75
Susurro 1000	8.95	0.59	38	0.10 / 0.39	0.75

Correction coefficient of the powers of the hot water coil*

Air inlet emperature [°C]	Water temperature gradient			
	60/40	55/50	45/40	35/30
0	1.32	1.51	1.21	0.9
5	1.16	1.34	1.05	0.75
10	1	1.18	0.89	0.6
15	0.84	1.02	0.74	0.45
20	0.69	0.87	0.59	0.3

* To apply to the C/O coil rated input power



CHARACTERISTICS OF CHANGE-OVER COIL (C/O)

For water temperature gradient 7/12 and inlet air temperature 25°C

Model	Rated Input	Water Pressure Loss	Air Pressure Loss	Water Flow	Connection Diameter
	kW	kPa	Pa	l/sec / m³/h	inches
Susurro 400	2.84	3.34	20	0.13 / 0.49	0.75
Susurro 700	4.21	6.77	55	0.20 / 0.72	0.75
Susurro 1000	5.66	3.73	42	0.27 / 0.97	0.75

Correction coefficient of the powers of the hot water coil*

Air inlet emperature [°C]	Water temperature gradient		
	7/12	6/11	5/10
20	0.42	0.52	0.61
25	1	1.1	1.19
30	1.69	1.78	1.88

* To apply to the C/O coil rated input power

Susurro

More options when choosing the heat recovery core type

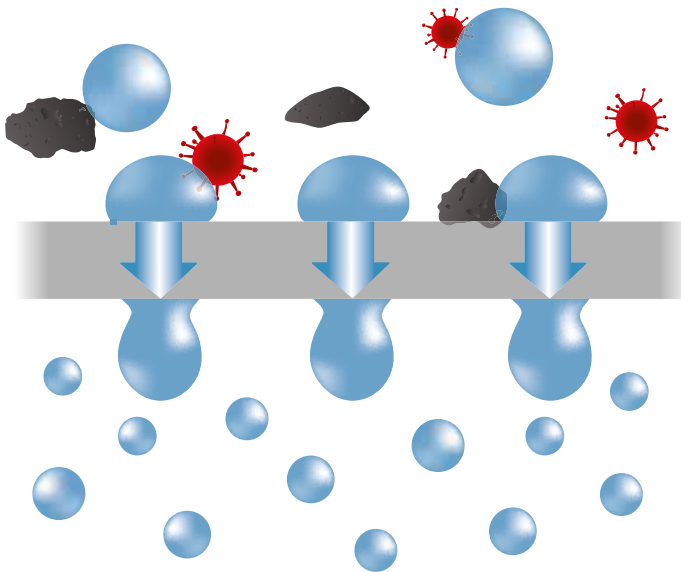

As part of the continuous research and development, the Susurro heat exchangers range has been extended throughout the heat exchanger type. Besides HRV (Heat Recovery Ventilation) features, Susurro range also has ERV (Energy Recovery Ventilation) features by adding the enthalpy heat exchanger option onto the range. ERV represents an upgrade for recovering not only the heat but also the moisture. Recovering the moisture within the air helps to prevent excess dryness during the cold season and reduce the air conditioning demand during the hot season.

As we spend approximately 90% of the time indoors during the winter, having ERV in certain buildings such as schools, hospitals, houses or apartments will help prevent dry throats, skin and irritated eyes.

The special polymer material used in the heat exchanger is semipermeable allowing the water vapours to go through, but other particles such as bacteria, odours, spores will not pass into the supply air stream. The enthalpy heat exchanger complies to ISO 846 and VDI 6022.

COMPARISON BETWEEN HRV (Heat Recovery Ventilation) AND ERV (Energy Recovery Ventilation)

	HRV	ERV
Heat exchanger material	Aluminium heat exchanger	Coated paper semipermeable enthalpic heat exchanger
Heat transfer	Good sensible transference	Fair sensible transference
Humidity transfer	No latent transfer	Good latent transfer

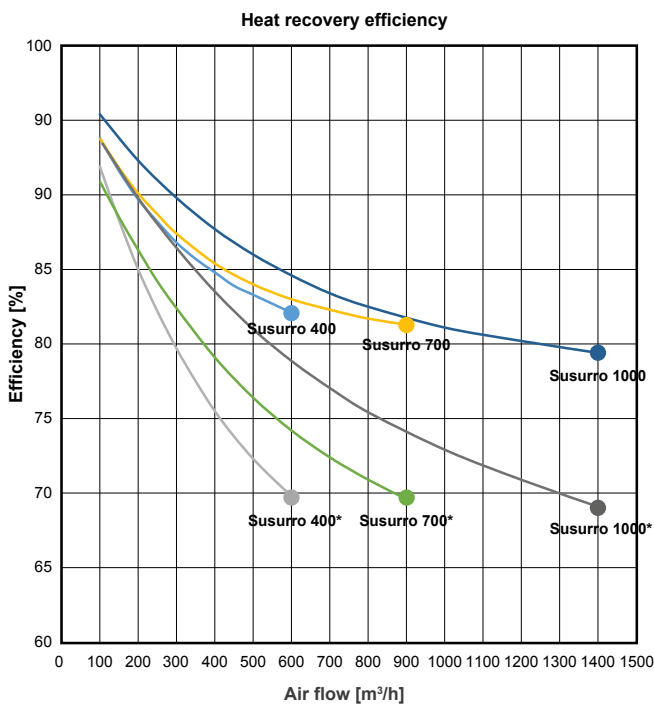

The data is measured under following conditions (EN308)
 Outdoor air temperature is +5°C, relative humidity 72%
 Indoor air temperature is +25°C, relative humidity 28%

*Enthalpic heat exchanger

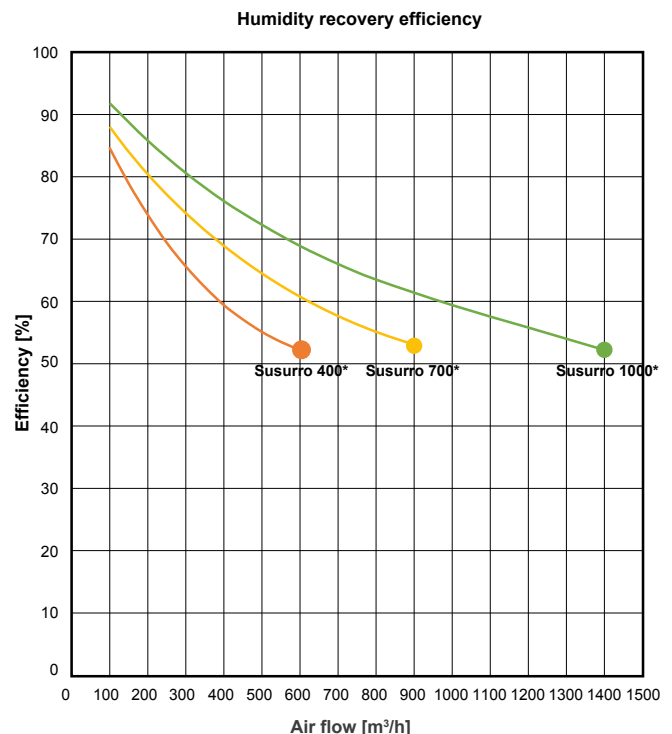

The data is measured under following conditions (EN308)
 Outdoor air temperature is +5°C, relative humidity 72%
 Indoor air temperature is +25°C, relative humidity 28%

*Enthalpic heat exchanger



Susurro units can be selected from its own Airflow selection software according to specific design requirements. The selection software is a highly useful tool providing marketing support and technical

information. The project designer can shift between the 5 tabs: Calculation specifications, Calculation results, Fan diagram, Sound levels and Dimensioned drawing.

The screenshot shows the "Airflow Susurro - Choose" software interface. It features a menu bar (File, Settings, Info) and a tabbed interface with five tabs: "Calculation specifications", "Calculation results", "Fan diagram", "Sound levels", and "Dimensioned drawing".

Calculation specifications tab:

- Post heating: All
- Pre-heating: Yes
- EN308 button
- Intake air:**
 - req. air flow volume: 250 l/s
 - external pressure loss: 100 Pa
 - Air values winter:**
 - Temperature: 5 °C
 - rel. humidity: 72 %
 - Air values summer:**
 - Temperature: 32 °C
 - rel. humidity: 50 %
- Extract air:**
 - req. air flow volume: 250 l/s
 - external pressure loss: 100 Pa
 - Air values winter:**
 - Temperature: 25 °C
 - rel. humidity: 28 %
 - Air values summer:**
 - Temperature: 22 °C
 - rel. humidity: 60 %
- Calculate button

Product details for Susurro-1000-EPRH-ST:

- Number of displayed units: 1
- Model list:
 - Susurro-1000-EPRH-ST
 - Susurro-1000-EPRH-EPOH-ST
 - Susurro-1000-EPRH-WPOH-ST
 - Susurro-1000-EPRH-DS
 - Susurro-1000-EPRH-EPOH-DS
 - Susurro-1000-EPRH-WPOH-DS
- Documentation:
 - ERF output
 - Manual
 - Techn. data sheet
 - DXF
- Image of the unit
- Dimensions:

Height	470 mm
Width	1710 mm
Length	2000 mm
Weight	240 kg
- Description:

The Susurro are highly efficient MVHR units designed for classroom and office use. They have an ambient temperature range of +5-40°C and provide fresh, healthy air, free from dust, chemicals and other pollutants to the occupied room. If the outdoor air temperature drops below freezing, the unit's optional pre-heater activates to warm the incoming air in order to prevent damage to the heat exchanger. Susurro offers completely automated controls, which optimise the unit's operation in order to achieve maximum energy efficiency and minimal heat losses. It is important to ensure that the design and installation of any ventilation system using Susurro is carried out correctly.

© Copyright AIRFLOW

Susurro

Computational Fluid Dynamics simulations

FLUID DYNAMICS

A standard classroom was used in a CFD (Computational Fluid Dynamics) simulation to see the velocity and temperature distribution.

The classroom dimensions are: (length x width x height) 10m x 7.5m x 3.3m, 75 m² area and 247.5m³ volume. A number of 30 students and 1 teacher was taken into account for calculating the simulation parameters.

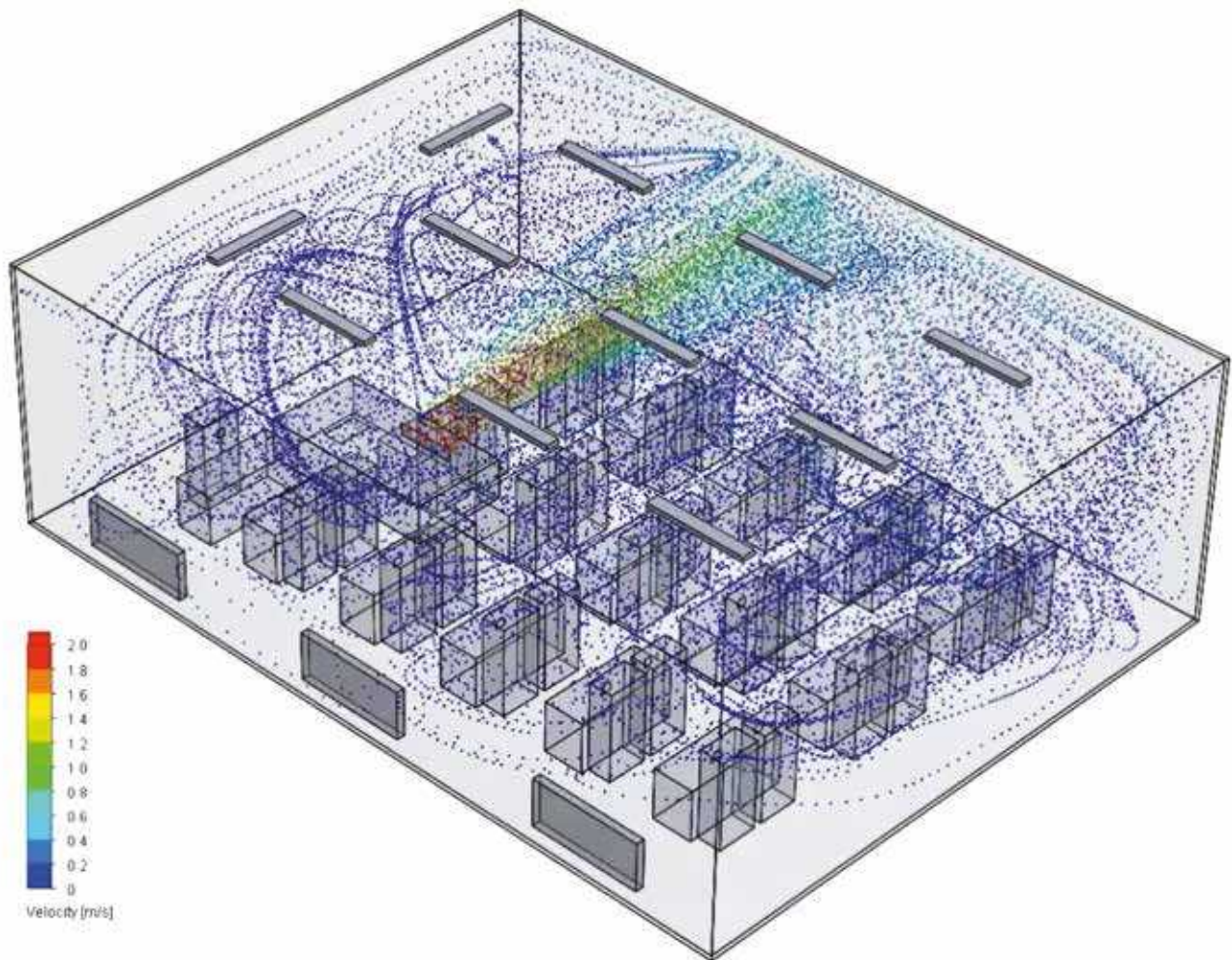



The CFD simulation results showed the optimal solution of having the unit installed in the middle of the longer wall of the classroom under the ceiling. The air flow hits the opposite wall, where is deflected equally to all directions, turns direction to the floor and creates slow reversed





flow. The air flow reaches all corners of the room and the entire room volume is ventilated by well mixed fresh air. Therefore, the air flow slows down by the time it reaches the occupied level to prevent having a draught effect.

ACCESSORIES

Filter replacement

Spare filter classes - ISO 16890 compliant

Description		Susurro 400	Susurro 700	Susurro 1000	Supply air filter
Standard	Coarse 60% (G4)	90000902	90000903	90000904	
	ePM1 60% (F7)	90000905	90000906	90000907	
Optional	ePM10 60% (M5)	90000908	90000909	90000910	 Note: 2 extract air filters required per unit.
	ePM1 70% (F8)	90000911	90000912	90000913	

Product	Description	Part number	
Condensate siphon	Siphon with a ball for installation on the wall or flush mounting	90000964	
Condensate siphon	Ball siphon for direct connection to the unit	90000965	
Condensate removal pump Silent+ Mini Orange	The quietest condensation pump in its class. Featuring an acoustic damper, anti-vibration tubing & bracket, the Silent+ Mini Orange is whisper quiet.	90000951	
External grilles	Circular external weather louvre complete with bird mesh for outdoor air intake and extract air discharge	D=250mm (for Susurro 400): 90000962 D=315mm (for Susurro 700/1000): 90000963	

Silent+ MINI ORANGE

Compact and Quiet Condensate Pump



KEY FEATURES

- Continuously removes condensation from your MVHR unit
- Simple to install
- No more levelling or gravity pipe outlets
- Quietly pumps moisture in any direction
- 12 l/h maximum flow
- 10m maximum head (flow rate 6l/h)
- The quietest in its class, 19 dB(A)
- Ideal solution for domestic MVHR units and light commercial
- Plug and play

Silent+ MINI ORANGE

The Silent+ MINI ORANGE is the quietest condensate pump available that swiftly removes the condensate that's created during the usual heat recovery process.

This discrete addition to your residential MVHR system not only protects your unit from moisture damage but also helps to prevent mould growth within the system and minimises the risk of damp emanating from the unit.

Using a Silent+ MINI ORANGE ensures that you're getting a more reliable and efficient means for MVHR unit condensate removal.

Silent+ MINI ORANGE heat pumps are quick and easy to install, simply plug and play!

TECHNICAL DATA

Specification	Silent+ MINI ORANGE
Maximum flow at 0 head	12 l/h
Maximum recommended head	10 m
Maximum suction lift	2 m
Sound level @ 1m	19dB(A)
Power supply	230VAC/ 1ph /50Hz
Maximum water temperature	40°C
Discharge tube	6 mm ID
Protection class	IP21
Safety switch	3.0A Normally closed
Thermal protection	✓
Fully potted	✓
Self priming	✓
Part number	90000951

PERFORMANCE

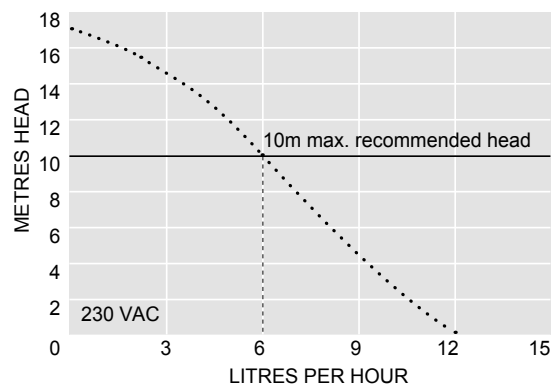

DIMENSIONS

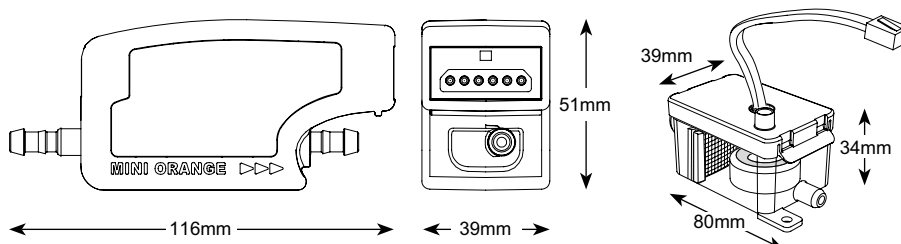

Max Hi-Flow

Powerful, efficient condensate pump



KEY FEATURES

- Continuous removal of condensation from your MVHR unit
- Simple to install
- No more levelling of gravity pipe outlets
- Easy access for routine maintenance
- Four inlet ports and one non return outlet barb
- Built-in spirit level
- Operation of the pump controlled via internal float
- Hi level safety switch operated by a second internal float
- 550 l/h maximum flow
- 5m maximum head (flow rate 55 l/h)
- The quietest in its class, 44 dB(A)
- The best IP rating of any tank pump (IP24 splash proof)
- 1.7 litre tank
- Plug and play

MAX Hi-Flow

The MAX Hi-Flow offers the ideal solution to commercial MVHR condensate removal when gravity and other systems aren't available or suitable.

Adding a MAX Hi-Flow pump to your existing commercial MVHR means that you can efficiently remove the condensate

that would otherwise turn into mould-up and damage your ventilation system and MVHR unit.

Thanks to its plug and play feature, the MAX Hi-Flow can be integrated into your existing commercial MVHR system with ease.

TECHNICAL DATA

Specification	MAX Hi-Flow
Maximum flow at 0 head	550 l/h
Maximum recommended head	5 m
Tank capacity	1.7l
Sound level @ 1m	44 dB(A)
Power supply	230 VAC/ 1 ph /50 Hz
Maximum water temperature	40°C
Inlets	4 x 21-27 mm
Outlet	6 & 10 mm
Protection class	IP24
Safety switch	3.0 A Normally closed
Thermal protection	✓
Dimensions	134h x 144w x 285d
Part number	90000748

DIMENSIONS

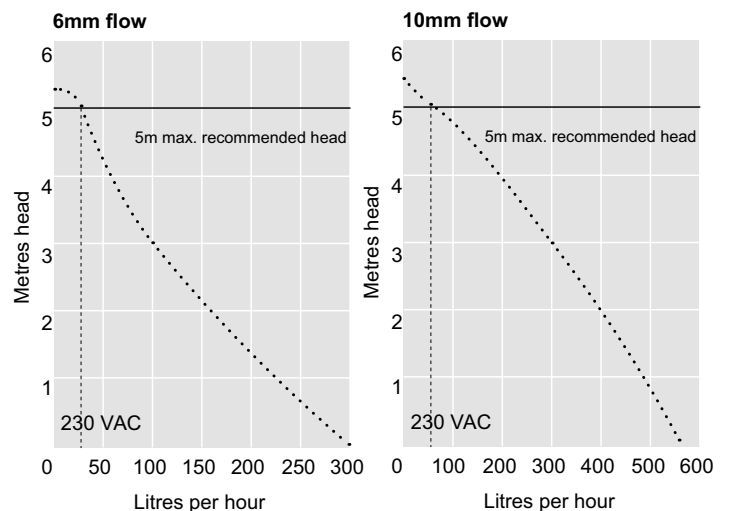

NO_x Filters

High quality air filters
Removes harmful pollutants from the air



KEY FEATURES

- Filters particulate matter and gases to remove pollutants prior to the air entering commercial buildings
- Additional filtration system above the air filters within the MVHR unit
- Filters up to 90% of harmful NO_x particles out the incoming air
- Ideal for buildings found in industrial areas and busy cities
- Improves the indoor air quality of the commercial building
- Variety of sizes available to fit your Duplexvent commercial MVHR unit
- Can be fitted to all Duplexvent commercial MVHR units

NO_x Filters

NO_x pollution is linked to 23,500 premature UK deaths a year and is particularly prevalent in areas with heavy traffic such as industrial areas and outside schools.

If you are constructing a commercial premises or school in a built-up area, it is important to ensure that you incorporate a NO_x filtration system as part of your wider ventilation system.

Airflow's NO_x filtration system works in conjunction with the unit's air filters to remove harmful air pollutants from the incoming air before it is distributed around the built environment.

By ensuring that the incoming air is at healthy levels, you ensure that health and wellbeing of those inside is protected as well as improving productivity and concentration levels.

KEY COMPONENTS



PERFORMANCE

Unit	Airflow Rating Unit (m ³ /s)	Dimensions (mm)			Required Filters	Clean PD at Rated Air Flow
		H	W	L		
CB50	0.055	220	310	980	4 x Gas Filter 2 x PM10 Filter	45Pa

Note: Other air flow rates are available up to 0.33 m³/s

VAV System

Zonal Control for your MVHR system



KEY FEATURES

- Variable air volume (VAV) ventilation system with compatible controller and VAV dampers
- Independent monitoring and air flow regulation for individual area requirements
- Intelligent, internet controlled dampers for fine adjustment of air flow
- Real time data transfer and regulation of VAV dampers from a central monitoring station
- Allows users to control the system through smartphone and PC
- Optimises the performance of an MVHR unit and reduces the ongoing operating costs of your ventilation system
- Helps analyse ventilation and heating (optional) energy costs by zone
- Doesn't require a BMS system
- Up to 63 dampers can be connected to a central unit
- Suitable for all commercial Duplexvent MVHR units

VAV System

The VAV System grants building managers a ventilation system that can responsively adapt to changes in ventilation demand in each section of large rooms or the building without the need for a BMS System.

The Airflow VAV system can be integrated with any commercial Duplexvent MVHR unit via an Ethernet cable and, due to the improved efficiency it provides, keeps the ongoing operating costs of the ventilation system down.

When integrated, the entire system is permanently and immediately controlled so that the central unit gives exactly the required air without unnecessarily wasting energy.

Various designs of the dampers enable them to be installed in various locations of the ventilation system and thanks to a comprehensive range of sizes, give this VAV system a wide range of applications.

KEY COMPONENTS

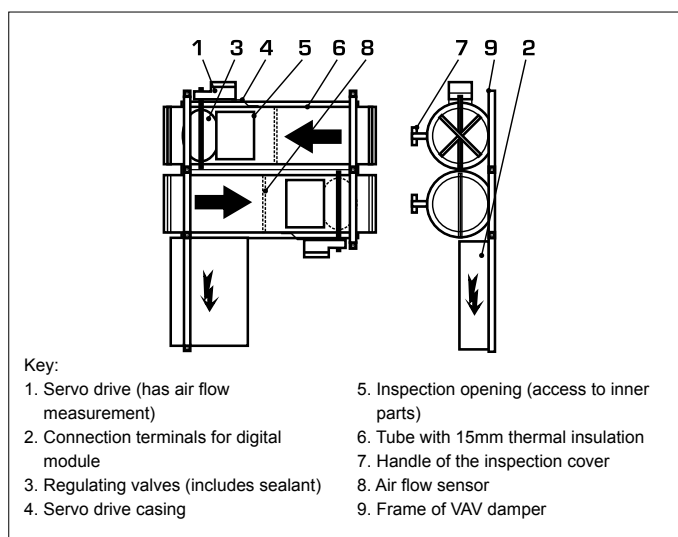

VAV SYSTEM RANGE



UNIT SELECTION

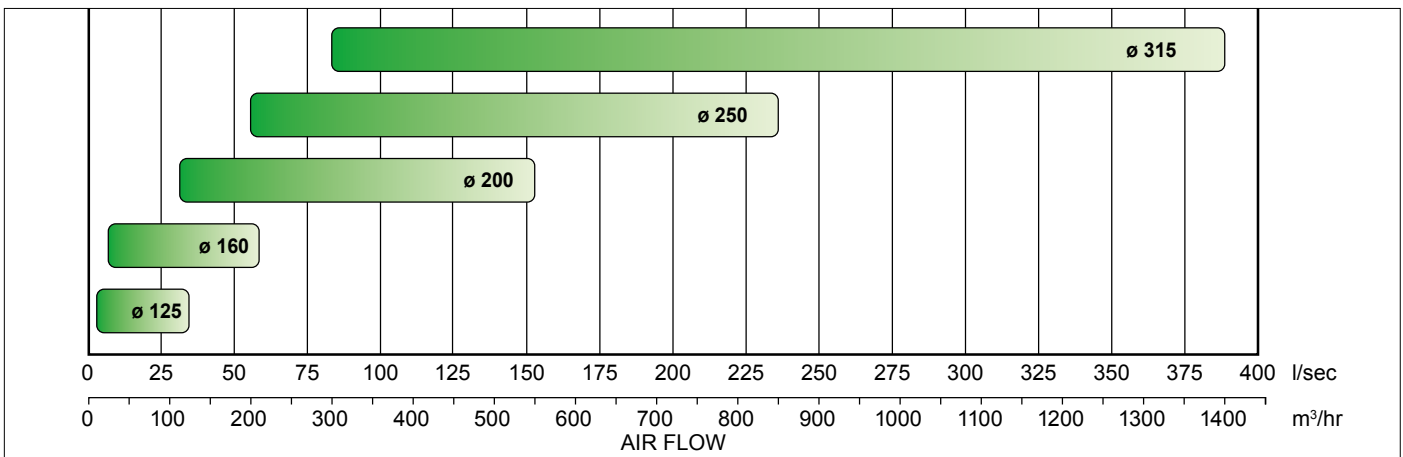

EXAMPLE SYSTEM

Duplexvent commercial MVHR unit with Web control

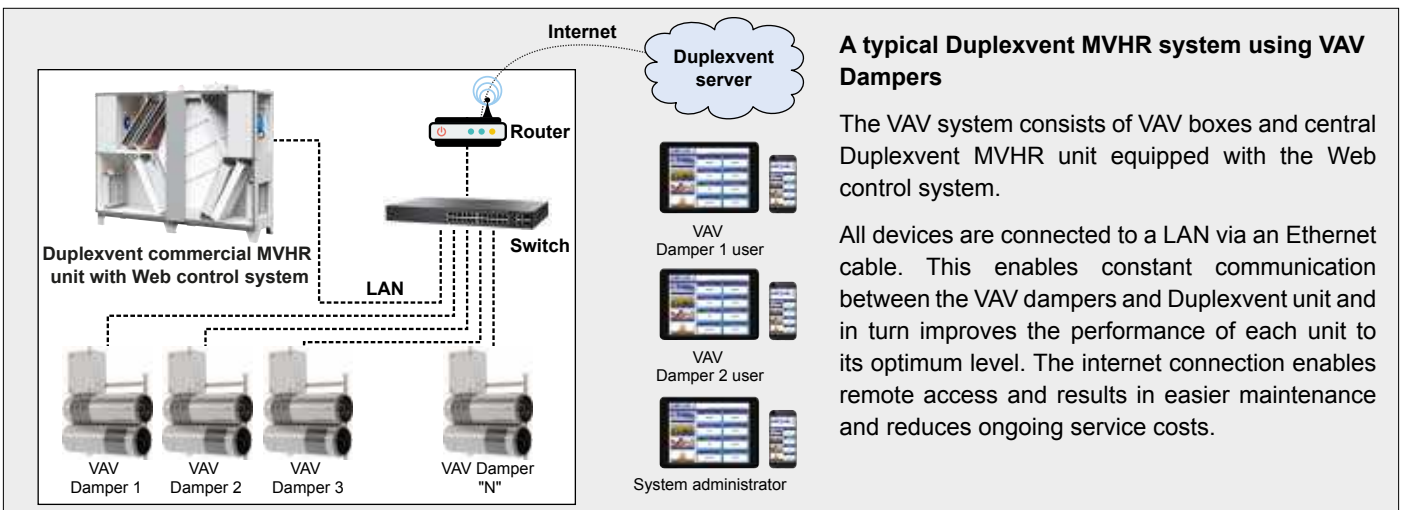

PERFORMANCE

VAV Damper	Working Point		Acoustic Performance L_{WA} (dB)								L_{WA} (dB)
	Pressure Loss (Pa)	Air Flow Volume (m^3/h) / (l/s)	63	125	250	500	1000	2000	4000	8000	
125	50	120 / 33	45.0	44.4	43.6	40.7	33.1	30.8	22.6	18.9	41.0
160		180 / 50	49.3	46.5	47.5	44.8	37.0	26.3	15.4	5.7	44.4
200		450 / 125	54.0	49.1	42.0	31.8	18.2	13.2	6.0	4.0	36.9
250		750 / 208	54.6	49.7	42.6	32.4	18.8	14.0	6.8	4.8	37.7
315		1300 / 361	55.7	50.8	43.7	33.5	19.9	14.8	7.6	5.6	38.5
125	150	120 / 33	49.0	49.9	54.1	52.8	47.0	43.5	41.3	41.7	53.5
160		180 / 50	42.6	54.0	52.0	53.5	47.5	43.4	36.6	31.5	53.6
200		450 / 125	52.1	49.9	47.9	47.5	42.1	34.2	32.7	23.7	47.6
250		750 / 208	52.7	50.5	48.5	48.1	42.7	35.0	33.5	24.5	48.4
315		1300 / 361	53.8	51.6	49.6	49.2	43.8	35.8	34.3	25.3	49.2
125	300	120 / 33	43.7	48.4	57.5	60.1	51.5	50.9	49.7	50.9	60.1
160		180 / 50	48.0	51.7	57.1	59.8	52.5	48.5	44.8	43.3	59.3
200		450 / 125	42.0	52.6	52.9	51.9	49.4	46.5	43.9	36.5	54.4
250		750 / 208	48.0	53.2	53.5	52.5	50.0	47.3	44.7	37.3	55.2
315		1300 / 361	59.0	54.3	54.6	53.6	51.1	48.1	45.5	38.1	56.0

DIMENSIONS

VAV Damper without cover

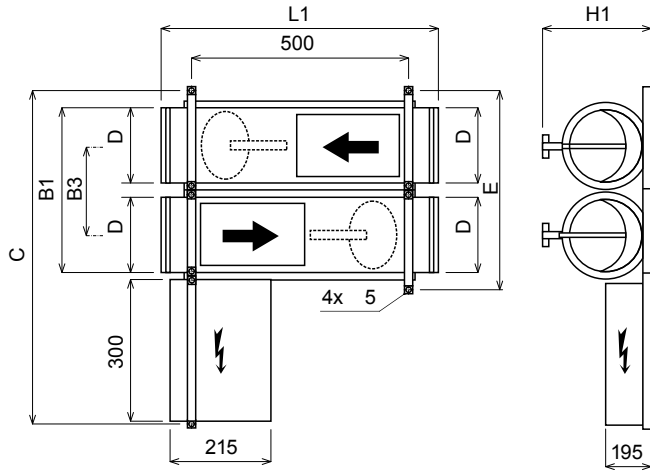

VAV Damper with cover

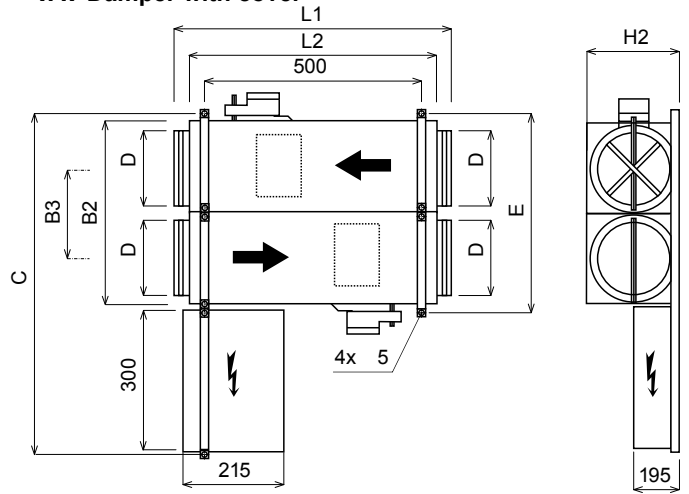

Values in brackets apply to VAV dampers (diameter symbol) 200-315 with servos inside

VAV Damper	B1 (mm)	B2 (mm)	B3 (mm)	C (mm)	D (mm)	E (mm)	L1 (mm)	L2 (mm)	H1 (mm)	H2 (mm)
125/125	387	397	198	800	125	429	590	540	155	185
160/160	457	467	235	870	160	499	590	540	190	220
200/200	537 (588)	547 (659)	304 (358)	1055	200	685	600	550	230	265
250/250	642 (698)	647 (781)	362 (418)	1175	250	804	700	650	280	315
315/315	765 (826)	777 (905)	419 (480)	1300	315	929	850	800	345	380

INSTALLATION

In order to achieve accurate flow control, it is necessary to keep a minimum calming distance of three times the diameter of the damper connection before the damper after an elbow or bend.

* Applies to VAV \varnothing 200-315 Dampers with servos inside

** When electric or water heaters are connected, this distance must be increased

The VAV damper box must remain accessible for commissioning the system and its ongoing maintenance

VAV Damper	X* (mm)	Y** (mm)	Z (mm)
125/125	750	500	225
160/160	850	500	225
200/200	1000	650	270
250/250	1100	750	320
315/315	1250	850	385

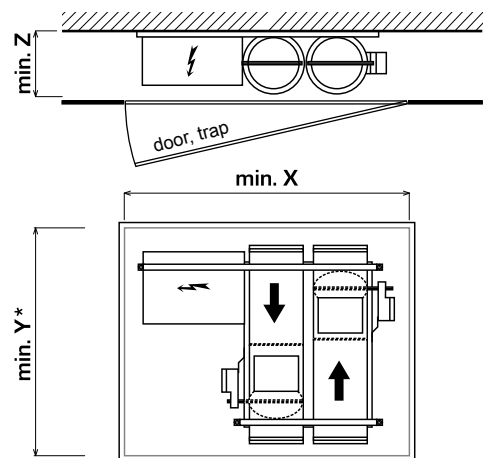
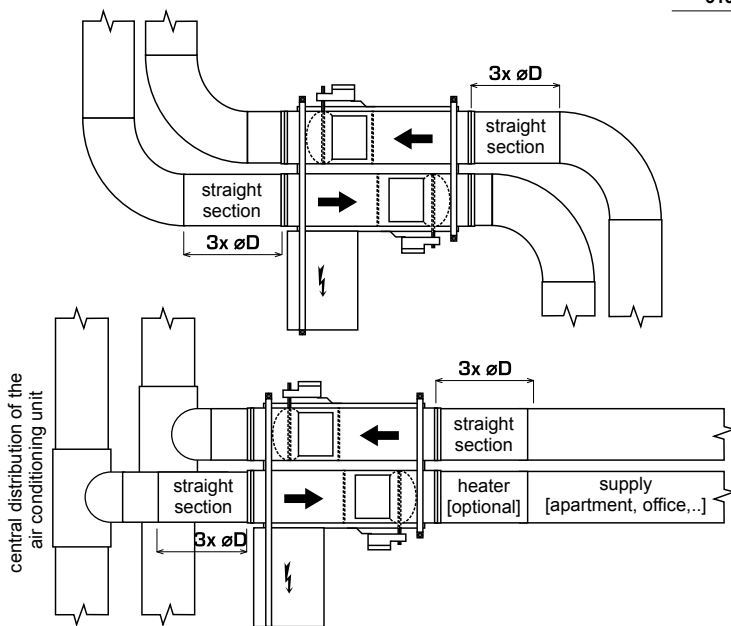

CONFIGURATION

General configuration - Divided*

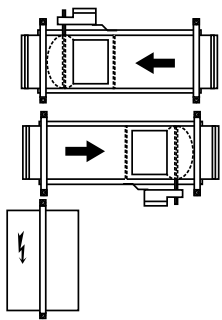

Tubes connection - Universal**

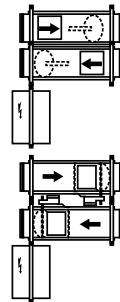
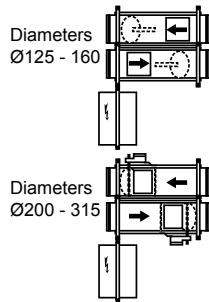

Terminal connection - Universal***

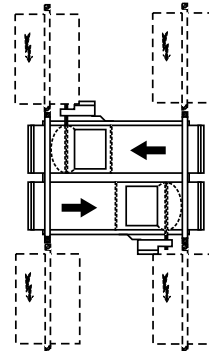

- * Maximum distance of control system from tubes is 20 m
- ** After connection of the supporting frames
- *** Connection terminal with the control system can be connected to any side using the supporting frame

CONTROLLERS

The following Airflow controllers can be used to control the VAV System:

WB1 Touch Controller

A digital, colour touch screen controller that enables the user to set all modes for the VAV system, including weekly scheduling and adjusting the entire system. This controller provides the user in-depth system information.



WB1 Touch controller

WB2 Rotary Controller

A variable speed controller with temperature adjustment (if equipped with the heater) and a switch off function.



WB2 Rotary controller



BC2 Rotary controller

BC2 Rotary Controller

A variable speed controller with a switch off function.

VAV PART NUMBERS

	Description	Part Number
	VAV Damper 125	90000736
	VAV Damper 160	90000737
	VAV Damper 200	90000738
	VAV Damper 250	90000739
	VAV Damper 315	90000740
	Metal Cover for VAV Damper 125	90000741
	Metal Cover for VAV Damper 160	90000742
	Metal Cover for VAV Damper 200	90000743
	Metal Cover for VAV Damper 250	90000744
	Metal Cover for VAV Damper 315	90000745

	Description	Part Number
	VAV Control Box	90000746
	WB1 Touch controller	90000710
	WB2 Rotary controller	90000785
	BC2 Rotary controller	90000408
	Switch 8-Port	90000734
	Switch 24-Port	90000735
	Router	90000733

DX Coil

Direct expansion
Cooling/Heating Coil



KEY FEATURES

- DX Cooling/Heating Coil for connection with outdoor heat pump unit
- Provides cooling effect in the summer and heats supply air in the winter
- Coil with copper pipes and aluminium fins
- Covered with hydrophilic layer to avoid moisture build-up
- Condensate drain incorporated
- Uses R410A refrigerant
- Can be mounted retrospectively
- Available in various size to match your unit

DX Coil

The DX coil operates with the outdoor heat pump unit to provide cooling or heating of the incoming air. A DX coil is a heat exchanger built from aluminium fins mounted on copper pipes to achieve maximum thermal efficiency under all operating conditions.

These accessories can be added to any Airflow Duplexvent centralised commercial MVHR unit and can be installed either

outside the casing (Flexi range) or built-in to the unit (Multi-eco, Rotary ranges).

They help to maintain a more comfortable indoor air environment during the summer months by cooling the incoming air and top up the temperature during the winter to achieve the requested supply temperature.

DX coils are available in a variety of sizes and capacities to match your chosen Duplexvent commercial MVHR unit.

KEY COMPONENTS



PERFORMANCE

Refer to Duplexvent selection software









Duplexvent Commercial Accessories

FLEXI LINE ACCESSORIES

Part No.	Description	Product Image	DV1100	DV1600	DV2600	DV3600
Extract air filter						
90000174	M5 filter		⊙	-	-	-
90000083	M5 filter		-	⊙	-	-
90000085	M5 filter		-	-	⊙	-
90000139	M5 filter		-	-	-	⊙
Supply air filter						
90000175	F7 filter		⊙	-	-	-
90000084	F7 filter		-	⊙	-	-
90000086	F7 filter		-	-	⊙	-
90000140	F7 filter		-	-	-	⊙
Flexible connector						
90000169	250 mm connection		⊙	-	-	-
90000095	315 mm connection		-	⊙	-	-
90000096	500 x 250 mm connection		-	-	⊙	-
90000134	600 x 300 mm connection		-	-	-	⊙
Shut-off damper with spring return						
90000172	250 mm connection		⊙	-	-	-
90000098	315 mm connection		-	⊙	-	-
90000100	500 x 250 mm connection		-	-	⊙	-
90000137	600 x 300 mm connection		-	-	-	⊙
Shut-off damper without spring return						
90000181	250 mm connection		⊙	-	-	-
90000097	315mm connection		-	⊙	-	-
90000099	500 x 250 mm connection		-	-	⊙	-
90000182	600 x 300 mm connection		-	-	-	⊙
Electric duct heater						
90000173	3.0 kW, 250 mm connection		⊙	-	-	-
90000091	6.0 kW, 315 mm connection		-	⊙	-	-
90000092	10.5 kW, 500 x 250 mm connection		-	-	⊙	-
90000138	13.5 kW, 600 x 300 mm connection		-	-	-	⊙
Water heating coil + duct temp. sensor (floor standing position)						
90000200	5.4 kW at 60/40°C		⊙	-	-	-
90000202	7.8 kW at 60/40°C		-	⊙	-	-
90000204	12.0 kW at 60/40°C		-	-	⊙	-
90000206	16.0 kW at 60/40°C		-	-	-	⊙











Duplexvent Commercial Accessories

FLEXI LINE ACCESSORIES

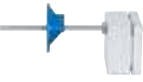
Part No.	Description	Product Image	DV1100	DV1600	DV2600	DV3600
Water heating coil + duct temp. sensor (ceiling suspended position)						
90000201	5.4 kW at 60/40°C		⊙	-	-	-
90000203	7.8 kW at 60/40°C			⊙		
90000205	12.0 kW at 60/40°C		-	-	⊙	-
90000207	16.0 kW at 60/40°C		-	-	-	⊙
Hydraulic kit (water heater) including 4-way valve with mixing pump and actuator						
90000105	Hydraulic kit for water heater		⊙	⊙	⊙	⊙
Water cooling coil + duct temp. sensor + RD-IO circuit board + free chamber (floor standing position)						
90000192	3.4 kW at 6/12°C		⊙	-	-	-
90000194	4.8 kW at 6/12°C		-	⊙	-	-
90000196	7.5 kW at 6/12°C		-	-	⊙	-
90000198	11.0 kW at 6/12°C		-	-	-	⊙
Water cooling coil + duct temp. sensor + RD-IO circuit board + free chamber (ceiling suspended position)						
90000193	3.4 kW at 6/12°C		⊙	-	-	-
90000195	4.8 kW at 6/12°C		-	⊙	-	-
90000197	7.5 kW at 6/12°C		-	-	⊙	-
90000199	11.0 kW at 6/12°C		-	-	-	⊙
Hydraulic kit (water cooler) including 3-way valve and actuator						
90000161	Hydraulic kit for water cooler		⊙	⊙	⊙	⊙
Water heating/cooling coils + duct temp. sensor + RD-IO circuit board (floor standing position)						
90000184	5.4 kW at 60/40°C, 3.4 kW at 6/12°C		⊙	-	-	-
90000186	7.8 kW at 60/40°C, 4.8 kW at 6/12°C		-	⊙	-	-
90000188	12.0 kW at 60/40°C, 7.5 kW at 6/12°C		-	-	⊙	-
90000190	16.0 kW at 60/40°C, 11.0 kW at 6/12°C		-	-	-	⊙
Water heating/cooling coils + duct temp. sensor + RD-IO circuit board (ceiling suspended position)						
90000185	5.4 kW at 60/40°C, 3.4 kW at 6/12°C		⊙	-	-	-
90000187	7.8 kW at 60/40°C, 4.8 kW at 6/12°C		-	⊙	-	-
90000189	12.0 kW at 60/40°C, 7.5 kW at 6/12°C		-	-	⊙	-
90000191	16.0 kW at 60/40°C, 11.0 kW at 6/12°C		-	-	-	⊙
RD-IO circuit board						
90000094	Additional PCB (all units)		⊙	⊙	⊙	⊙
DX coil (floor standing position)						
90000178	DX (direct expansion) coil		⊙	-	-	-
90000147	DX (direct expansion) coil		-	⊙	-	-
90000149	DX (direct expansion) coil		-	-	⊙	-
90000151	DX (direct expansion) coil		-	-	-	⊙









Duplexvent Commercial Accessories

FLEXI LINE ACCESSORIES

Part No.	Description	Product Image	DV1100	DV1600	DV2600	DV3600
DX coil (ceiling suspended position)						
90000179	DX (direct expansion) coil		⊙	-	-	-
90000148	DX (direct expansion) coil		-	⊙	-	-
90000150	DX (direct expansion) coil		-	-	⊙	-
90000152	DX (direct expansion) coil		-	-	-	⊙
Free chamber for water / DX cooling coils						
90000180	Free chamber		⊙	-	-	-
90000153	Free chamber		-	⊙	-	-
90000154	Free chamber		-	-	⊙	-
90000155	Free chamber		-	-	-	⊙
Constant flow kit (including two pressure sensors)						
90000093	Constant flow kit		⊙	⊙	⊙	-
90000167	Constant flow kit		-	-	-	⊙
Constant pressure box						
90000208	Constant pressure box		⊙	⊙	⊙	⊙
VDI 6022 hygiene pack with inclined tube manometers						
90000090	VDI 6022 hygiene pack		⊙	⊙	⊙	⊙
Duct temperature sensor						
90000089	Duct temp. (0-24 V output)		⊙	⊙	⊙	⊙
Room humidity sensor						
90000320	Room rh (0-10 V output)		⊙	⊙	⊙	⊙
Duct humidity sensor						
90000313	Duct rh (0-10 V output)		⊙	⊙	⊙	⊙
Room CO₂ sensor						
90000166	Room CO ₂ (0-10 V output)		⊙	⊙	⊙	⊙
Duct CO₂ sensor						
90000165	Duct CO ₂ (0-10 V output)		⊙	⊙	⊙	⊙
Room air quality sensor						
90000321	Room air quality (0-10 V output)		⊙	⊙	⊙	⊙











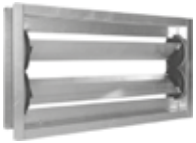

Duplexvent Commercial Accessories

MULTI ECO RANGE ACCESSORIES

<p>Bypass Damper</p> <p>Provides a flow of cool, fresh and filtered air into the property.</p>		<p>Inclined Manometers</p> <p>Shows the real-time pressure loss of the filters.</p>	
<p>Shut-Off Dampers</p> <p>Fitted on the unit's inlet, the dampers are supplied with a conventional servo drive with an emergency shut-off in the event of emergencies.</p>		<p>EPO-V Electric Post-Heaters</p> <p>Can be installed in circular or rectangular ducts that are connected to the unit.</p>	
<p>RE-TPO Control Manifolds for Hot Water Air Heaters</p> <p>Control the heating performance of the hot water heaters. They consist of a three-speed pump, two shut-off ball valves and a three or four-way mixing manifold with a Belimo servo drive.</p>		<p>CHW Chilled Water Cooler</p> <p>Built into the unit.</p>	
<p>Flexible Flanges</p> <p>Can be fitted on circular and rectangular ports. Available in all unit port dimensions.</p>		<p>Constant Flow and Pressure Control</p> <p>Manometers read the air pressure of the fan and the inlet.</p>	
<p>Circulation Damper</p> <p>Fitted with motorised damper.</p>		<p>Spare Filter Casings</p> <p>Available in all unit sizes and can be supplied with G4 (ISO Coarse 60%), M5 (ISO ePM10 70%) or F7 (ISO ePM2.5 65%) air filters.</p>	
<p>Air Filters</p> <p>All Multi eco units can be fitted with G4 (ISO Coarse 60%), M5 (ISO ePM10 70%) or F7 (ISO ePM2.5 65%) air filters.</p>		<p>CHF Direct Cooler</p> <p>Built into the unit.</p>	
<p>EPO-V Electrical Pre-Heater</p> <p>Ensure protection of the heat exchanger from frost. They are installed in the duct on the fresh air inlet side of the unit.</p>		<p>R-CHW Control Manifolds for Chilled Water Coolers</p> <p>Controls the cooling performance of the chilled water coolers.</p>	
<p>T Hot Water Air Heater</p> <p>Integrated in the unit. Suitable for systems up to 110°C and 1.0 MPa. Unique design makes them suitable for low temperature sources.</p>			

Duplexvent Commercial Accessories

ROTARY RANGE ACCESSORIES

<p>Shut-Off Dampers Fitted to the unit's inlet port.</p>		<p>Air Filters All Rotary units can be fitted with G4 (ISO Coarse 60%), M5 (ISO ePM10 70%) or F7 (ISO ePM2.5 65%) air filters.</p>	
<p>RE-TPO Control Manifolds for Hot Water Air Heaters Control the heating performance of the hot water heaters.</p>		<p>Circulation Damper Fitted with motorised damper.</p>	
<p>Flexible Flanges Can be fitted on circular and rectangular ports. Available in all unit port dimensions.</p>		<p>T Hot Water Air Heater Integrated in the unit. Suitable for systems up to 110°C and 1.0 MPa. Unique design makes them suitable for low temperature sources..</p>	
<p>EPO-V Electrical Post-Heater Installed in the duct on the fresh air inlet side of the unit.</p>		<p>CHF Direct Cooler Built into the unit.</p>	
<p>CHW Chilled Water Cooler Built into the unit.</p>		<p>R-CHW Control Manifolds for Chilled Water Coolers Controls the cooling performance of the chilled water coolers.</p>	
<p>Constant Flow and Pressure Control Manometers read the air pressure of the fan and the inlet.</p>		<p>Inclined Manometers Shows the real-time pressure loss of the filters.</p>	

THE BENCHMARK



The highest quality air for your family



Ventilation with Heat Recovery

Residential

With ever increasing energy costs the need to conserve heat and power is leading to higher levels of insulation and air tightness in residential dwellings leading to poor indoor air quality.

In a healthy home, thousands of litres of fresh air are needed every day to replace the moist air generated by each individual person, and also through cooking, washing and bathing.

The indoor climate is of the utmost importance as most of us spend the greater part of our lives indoors. To ensure comfort and a sense of wellbeing, the air we breathe should be clean, and also be at the right temperature and humidity level. Whatever the situation, Duplexvent Mechanical Ventilation with Heat Recovery solutions can play a significant role as they help create a healthier living environment whilst saving valuable energy.

DUPLEXVENT ADROIT RANGE

A range of compact, entry level mechanical ventilation units with heat recovery designed for social housing, private sector apartment blocks and terraced houses. The units provide high efficiency, low power consumption and low noise balanced ventilation solutions which help meet current Building Regulations. If the dwelling does not have space for a central unit then Airflow manufactures a unit that can go above your hob and also carry out the function of a cooker hood.

Having up to 90% thermal efficiency, Duplexvent Adroit units provide a hygienic and comfortable environment at all times. With our Passive House Institute certified and SAP Q eligible models, Duplexvent Adroit is the perfect choice for your whole house ventilation.

These Mechanical Ventilation with Heat Recovery units are available with a unique triple filter system ensuring healthy and fresh indoor air. All units offer automatic summer by-pass and have the option of smart frost protection.

Adroit units enable remote control and monitoring of the unit's ventilation and through the Adroit Cloud Service, offer advanced control functions. The Adroit digital controller has advanced functionality integrated into intuitive icons. The ventilation control is based upon four profile options: Home, Away, Boost and Fireplace. Besides, the Adroit Cloud Control is a remote-control option throughout the Internet.

The Adroit heat recovery units have a built-in humidity sensor which monitors the indoor humidity level and adjusts the ventilation, accordingly.

Furthermore, the Adroit ventilation units can also be automatically adjusted through additional sensors which will detect different types of VOCs (Volatile Organic Compounds), to ensure indoor air quality.

DV51CH Adroit

Adroit Line Top Entry -
Up to 170 m³/h air volume



KEY FEATURES

- Flow rate up to 47 l/sec (170 m³/h) at 100 Pa
- Up to 84% thermal efficiency and low SFP
- Internet control by smart phone, tablet or PC
- Two G4 (ISO Coarse > 75%) and one F7 (ISOePM1) filters
- Full heat recovery for the whole dwelling
- Slim and stylish extractor hood
- Can be integrated into a standard 600 mm wide kitchen unit
- Optional LCD digital controller with four independent environmental profiles
- Optional built-in electric heater
- Complies with Building Regulations
- Cooker hood available in white and stainless steel
- Fits neatly as part of an integrated solution
- Built-in humidity sensor
- 5 year warranty+

DV51CH ADROIT

The DV51CH Adroit is a compact kitchen unit incorporating a cooker hood extractor, designed to perfectly combine ventilation and extraction of cooking odours.

The heat recovery unit is delivered with a slim and stylish cooker hood, manufactured from metal providing a fire safe ventilation solution for kitchen installations. The DV51CH Adroit MVHR unit can be easily integrated in the kitchen design as the cooker hood is available in white or stainless steel. This kitchen ventilation solution is also an efficient use of space in small apartments. The grease filter which protects the MVHR unit against cooking particles can be easily cleaned in soapy water.

A unique feature of the DV51CH Adroit is the benefit of recovering the heat from the hob while other kitchen units discharge directly to outside, skipping the heat recovery process.

PERFORMANCE

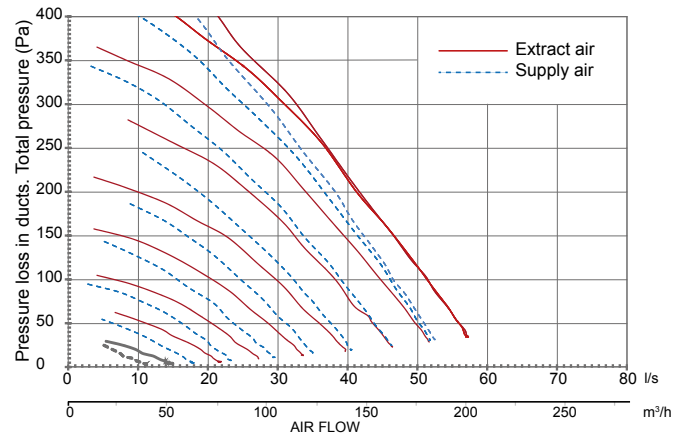

* Guidance only. Dependant upon system pressure.

DIMENSIONS

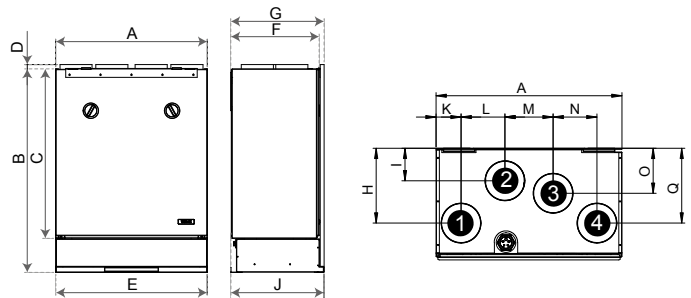

Duct outlets, Model R

Inner diameter of female outlet collar \varnothing 125 mm

1. Extract air from the apartment to the unit
2. Supply air from the unit to the apartment
3. Exhaust air flowing outdoors from the unit
4. Outdoor air to the unit

Duct outlets, Model L

Inner diameter of female outlet collar \varnothing 125 mm

1. Outdoor air to the unit
2. Exhaust air flowing outdoors from the unit
3. Supply air from the unit to the apartment
4. Extract air from the apartment to the unit

+ excludes motors. Motor warranty one year from date of purchase

Model	A	B	C	D	E	F	G	H	I
DV51CH	598	802	668	17	597	249	368	241	105
	J	K	L	M	N	O	P		
	598	81	141	155	141	145	241		

TECHNICAL DATA

Specification	DV51CH (R) Adroit	DV51CH (L) Adroit
Suitable for dwellings up to m ²	75	75
Air flow m ³ /h / l/s @100 Pa	170 / 47	170 / 47
Thermal efficiency	Up to 83%	Up to 83%
Heat exchanger	Counterflow (Aluminium)	Counterflow (Aluminium)
Fans	EC	EC
Summer bypass damper	100% automatic	100% automatic
Frost protection	Stop supply fan	Stop supply fan
Controls	Capacitive buttons with 3 speed profiles (on cooker hood)	Capacitive buttons with 3 speed profiles (on cooker hood)
Digital controls	Optional digital - 4 profiles, 100% adjustable	Optional digital - 4 profiles, 100% adjustable
Mounting	Wall	Wall
Sound level @ 3m (dB(A))	28	28
Duct diameter (mm)	4x125	4x125
Condensate discharge (mm)	12	12
Electrical supply	230 V / 1 ph / 50 Hz	230 V / 1 ph / 50 Hz
Max. power consumption	119 W	119 W
Filter class	2xG4 (ISO Coarse > 75%) / 1xF7 (ISO ePM1)	2xG4 (ISO Coarse > 75%) / 1xF7 (ISO ePM1)
Built-in electric post-heater (optional)	900 W	900 W
Protection class	IP34	IP34
Casing insulation (mm)	10	10
Weight (kg)	66.2 (including cooker hood)	66.2 (including cooker hood)
Dimensions (L x D x H) (mm)	598x349x802 (including cooker hood)	598x349x802 (including cooker hood)
Part No.	90001174 (white) 90001172 (stainless steel)	90001175 (white) 90001173 (stainless steel)



DV51CH Adroit

Adroit Line Top Entry -
Up to 170 m³/h air volume

DV51CH ADROIT

The DV51CH Adroit is fitted with a triple air filter facility which consists of two G4 (ISO Coarse > 75%) and one F7 (ISO ePM1) filters. The air filtration will help prevent small pollen particles from entering indoors.

Adjusting the ventilation characteristics according to specific lifestyles has never been so easy and efficient. Ventilation in a small apartment can be fully controlled through different options of controllers: a switch controller, capacitive touch buttons on the cooker hood front panel, a digital Adroit controller with 4 individual ventilation profiles or via the Internet or a local network using a laptop, smartphone, tablet etc.

The DV51CH Adroit can be integrated within the kitchen units and matched with other kitchen appliances offering an elegant

overall style to the entire dwelling. This unit is ideally installed in one- or two-bedroom flats or a small three-bedroom apartment. Saving space and energy, the DV51CH Adroit unit is also easy to maintain and service, having plenty of front space to replace the filters and clean the grease filter grille.

The DV51CH can be integrated with a Building Management System (BMS) via a Modbus connection or KNX, which allows the user to monitor and control the unit's functions via a central control system.

NEW STYLISH AND COMPACT DESIGN

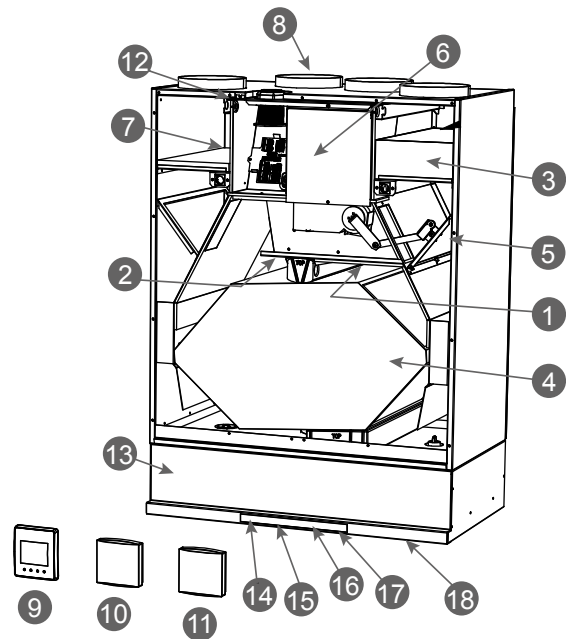

The internal humidity sensor ensures automatic boosting of the ventilation profile when required.

As previously stated, the unique feature of this MVHR Adroit unit is recovering the heat coming from the hob into the heat exchanger, a total energy class of A+ (in cold climate) is obtained.

The DV51CH Adroit cooker hood has a modern and intuitive front panel which blends in with the kitchen furniture design. Two colours are available for the cooker hood: white and stainless steel. In addition, the unit can be customised further by using the brackets provided to hang a matching kitchen unit door. The kitchen door will have the standard width of 600 mm.

- ① Extract fan
- ② Supply fan
- ③ Supply filter
- ④ Heat exchanger
- ⑤ Bypass actuator
- ⑥ Connection box
- ⑦ Extract filter
- ⑧ Post heater
- ⑨ Control panel
- ⑩ CO₂ sensor (optional)

- ⑪ Humidity sensor (optional)
- ⑫ Internal humidity sensor
- ⑬ Cooker hood
- ⑭ Damper button
- ⑮ Fan speed buttons
- ⑯ LED light button
- ⑰ Selection button
- ⑱ Grease filter

CONTROLS

- 

Damper s position
The damper is opened by pressing the damper button (light turns on). The damper is closed (light iturns off) by pressing the damper button or automatically after one hour (without a timer or 45-120 min when programmed).
- 

Cooker hood light
Turn the light on or off by pressing the light switch. The brightness of the light can be adjusted.
- 

Ventilation profiles
Select the profile by pressing the fan speed button repeatedly until the signal light indicates the desired ventilation profile:
- 

Away profile
Use this ventilation profile when the apartment is unoccupied, e.g. during holiday.
- 

At home profile
Use this ventilation profile when the apartment is occupied.
- 

Boost profile
Use this profile to enhance ventilation, e.g. when there are more people than usual in the apartment.
- 

Selection button
The selection button is used to adjust the brightness of the cooker hood LED.

DV51CH Slim-Line Cooker Hood

Colour options of white or brushed stainless steel

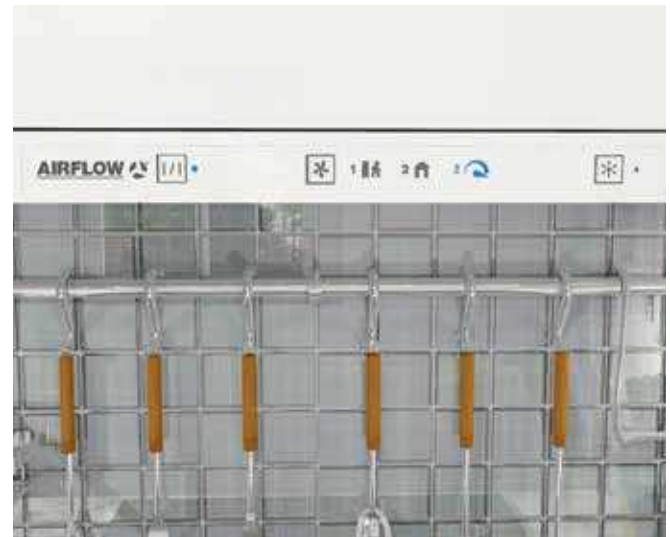

- **4 ventilation profiles**, 100% adjustable
- **Internet connection** available
- **Automatic boost function** with delay timer
- **Filter maintenance reminder** via counter clock (standard)
- **Heater control** for optional post-heater
- **Connection to BMS** via LON or KNX
- **Self diagnostic** via fault signal relay
- **On-demand control** via humidity and CO² sensors
- **Separate fan control** for ease of commissioning
- **Weekly ventilation programming** allows users to pre-set the ventilation levels scheduled for different days
- **Indoor temperature control** based on extract air temperature or supply air temperature
- 100% adjustable speed levels
- User friendly for quick and simple control.

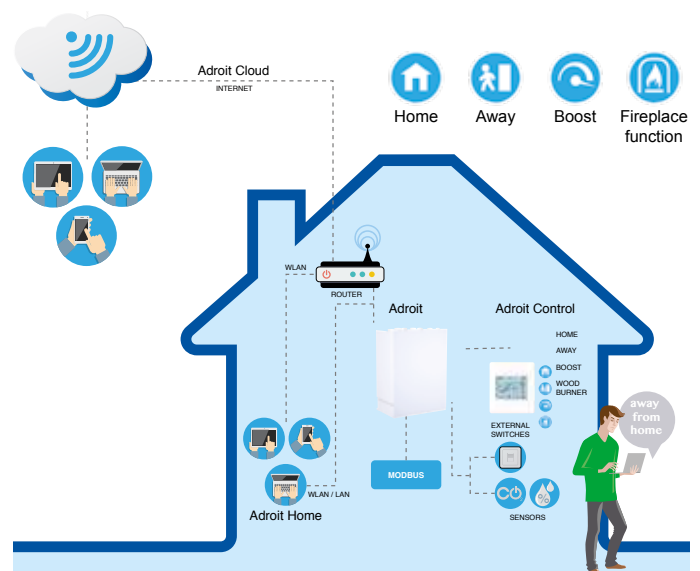

Duplexvent Adroit

Heat Recovery Ventilation

KEY COMPONENTS

Low energy, maintenance free EC fan technology ensures long term savings on operating costs

F7 (ISO ePM1) High grade filter provides ultra hygienic indoor climate and prevents invisible particles from being supplied to the dwelling

Powder coated, galvanised steel casing with 20mm insulation avoids thermal bridging, absorbs noise and meets sanitary standards

Smart frost protection with innovative, energy saving frost heater to protect heat exchanger from freezing

Balancing tubes for easy and accurate commissioning

Temperature sensors for fully automatic operation of the summer bypass, frost protection and heater facilities

Moisture egress
Condensate drain

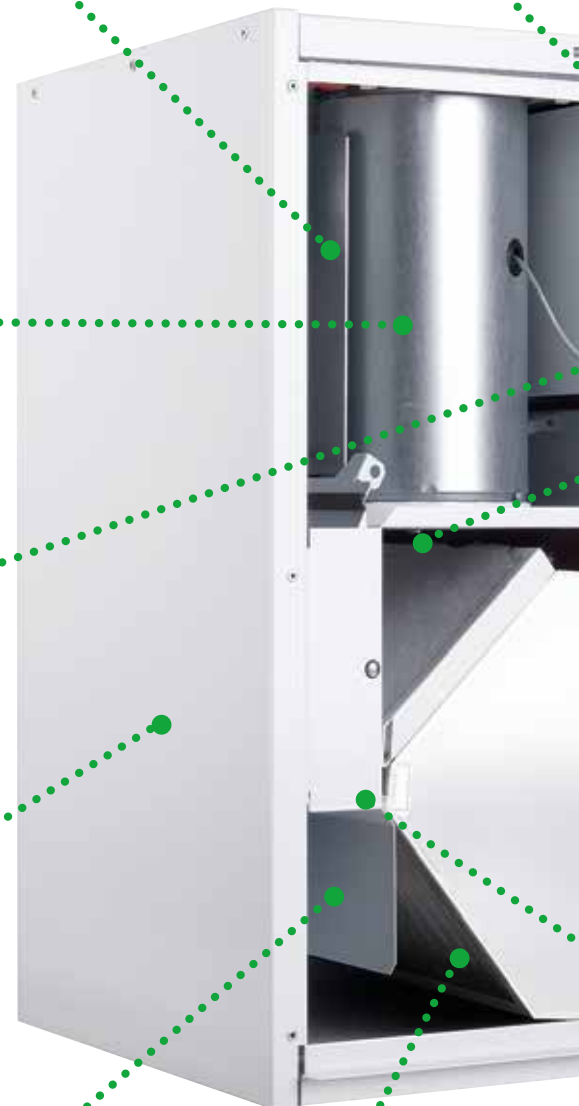



Optional post-heater
Built-in
for extra heating

Auto cut-out switch
provides extra safety
and simplifies the
maintenance process

**Supply & Extract G4
(ISO Coarse > 75 %)
filters** improve indoor air
quality and protect the
heat exchanger

Isolated control box
with digital control
and BMS
connection

**Low energy,
maintenance free
EC fan technology**
ensures long term savings
on operating costs

**Cross-Counter
flow heat exchanger**
many over 90% thermal
efficiency reduces heating
bills significantly and
guarantees a quick
return on investment

**100% Summer
bypass facility** provides
a flow of cool, fresh
and filtered air into the
property

Duplexvent Adroit

Heat Recovery Ventilation



KEY FEATURES

- Heat recovery ventilation
- Up to 90% thermal efficiency
- Unique triple filter design with F7 pollen filter
- Automatic, 100% summer by-pass
- Versatile unit positioning
- Smart frost protection
- Complies with Building Regulations, ErP and Passive House Institute certified when fitted with integral electric heater
- BMS (Modbus / KNX) connection
- Remote “on the go” Internet control available through the Adroit Clod web server
- 5 year warranty+

Duplexvent Adroit

The Adroit range selection is the perfect solution for social housing from small apartments to larger houses, passive houses or renovations.

Duplexvent Adroit units are high quality and efficient domestic mechanical supply and extract ventilation with heat recovery (MVHR) units. They are suitable for dwellings up to 400m² and can supply up to 258 l/s (DV245). In addition, the Adroit DV51CH kitchen ventilation solution is an efficient use of space in small dwellings designed to perfectly combine mechanical ventilation with heat recovery and extraction of cooking odours.

The casing is made of a galvanised steel, doubleskin that is powder coated (excluding DV50 and DV80) both internally and

externally to meet hygiene requirements. It contains significant insulation that avoids thermal bridging and significantly reduces noise levels. All units include an easily accessible and removable heat exchanger that recovers the heat from the outgoing airstream and uses this heat to pre-warm the incoming fresh air. At no point does the supply and extract airstreams mix.

Adroit MVHR units have several different mounting positions including wall, ceiling and floor.

+Excludes motors. Motor warranty one year from date of purchase

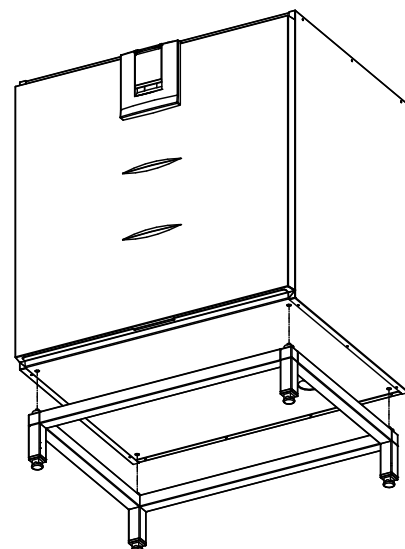
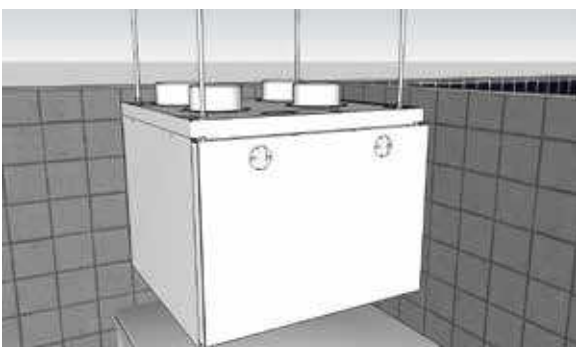

DV80



DV50

DV245



DV145

DV110

DV96



DV51CH

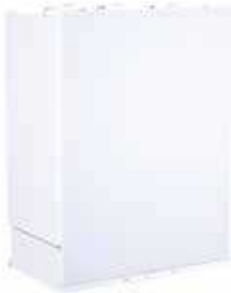

DUPLEXVENT ADROIT

The Duplexvent Adroit generation recovers very efficiently the heat of the extract air. Also, the Adroit units measure the indoor air relative humidity and automatically adjusts the air flow rates accordingly. They are perfectly designed to operate even in cold weather benefiting from smart frost protection.

The Adroit wide selection range can supply starting from 51 l/s for smaller dwellings reaching up to 230 l/s for larger homes.

Thanks to the multiple installation positions, the Adroit compact units are tailored to the individual needs of each customer.

DV51CH

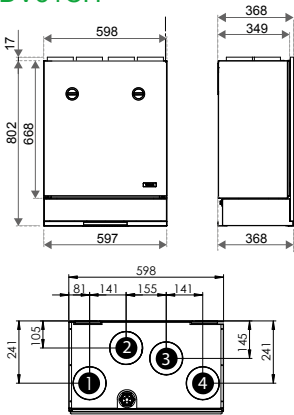

Dimensions	DV50 Adroit	DV80 Adroit
A	900	1026
B	547	626
C	236	293
D	100 (female)	125 (female)
E	87	110
F	197	254
G	86	110
H	161	200
I	161	200
J	86	96
K	96	96
L	206	231
M	498	624

DV50 / 80

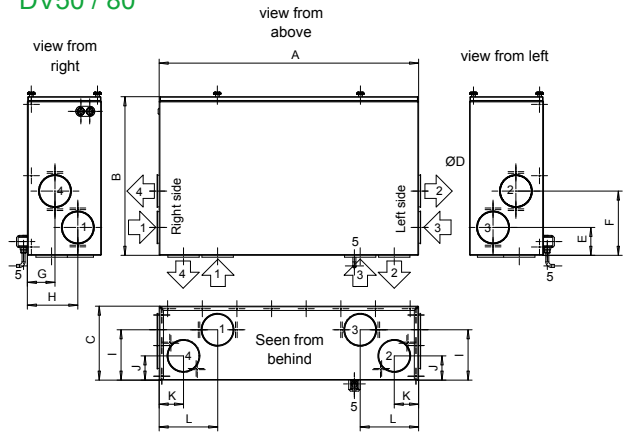

DV96

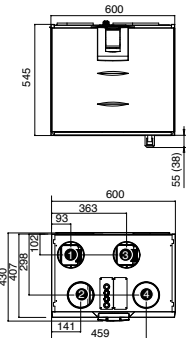

DV110

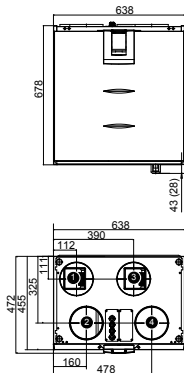

DV145

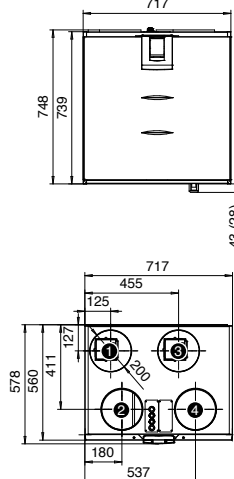

DV245

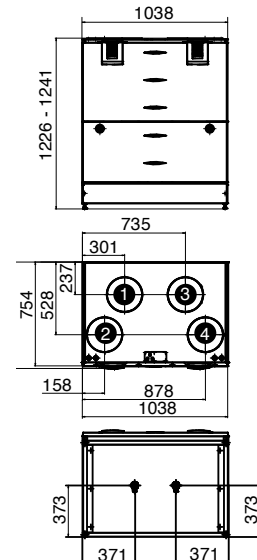

DV96 Adroit

Adroit Line Top Entry -
Up to 345 m³/h air volume



KEY FEATURES

- For use in dwellings up to 130 m² *
- Up to 90% thermal efficiency and low SFP
- 'A' energy rating
- Internet control by smart phone, tablet or PC
- Triple filter design with F7 pollen filter
- Automatic, 100% summer by-pass
- Integral Humidity Sensor
- Galvanised steel, double-skin casing
- BMS (Modbus / KNX) connection
- Optional LCD digital controller with four independent environmental profiles
- Optional manual four speed controller
- Auto cut-out switch for extra safety
- Optional built-in Electric Post-heater
- Optional smart frost protection
- Complies with Building Regulations and Passive House certified
- 5 year warranty+

DV96 ADROIT

With its powerful air volume capacity and high thermal efficiency the DV96 Adroit is suitable for medium sized family homes. Control your indoor air environment at home or on the go via the Adroit 'Cloud' internet control by smart phone, tablet or PC.

With the triple filter design with an F7 pollen filter, the DV96 Adroit provides additional protection against invisible, harmful particles and creates an ultra hygienic environment.

The automatic, 100% summer by-pass facility isolates the heat recovery function and helps to effectively maintain a temperate indoor air climate during the summer months.

The unit includes an easily removable, plastic heat exchanger and may be equipped with a range of optional accessories for higher performance.

PERFORMANCE

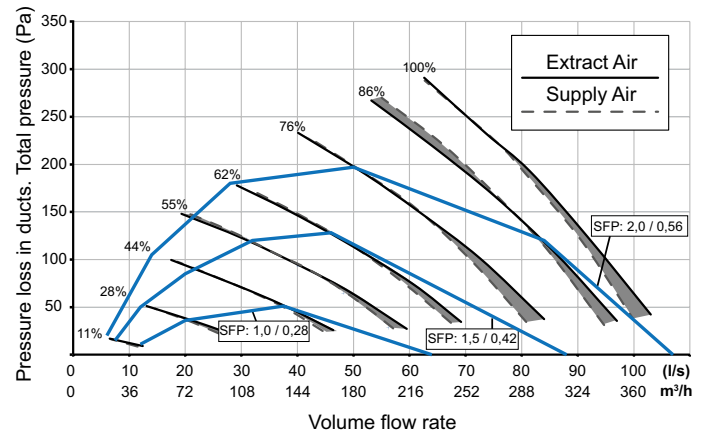

* Guidance only. Dependant upon system pressure.

DIMENSIONS

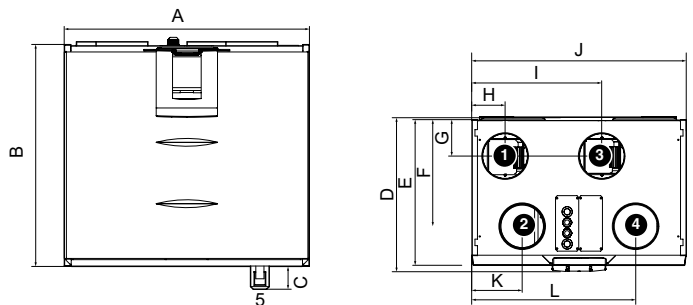

+ excludes motors. Motor warranty one year from date of purchase

Model	A	B	C	D	E	F	G	H	I	J	K	L
DV96	600	545	55	430	407	298	102	93	363	600	141	459

Duct outlets, model R

Inner diameter of female outlet collar \varnothing 125mm

1. Supply air to dwelling
2. Extract air from dwelling to unit
3. Exhaust air out
4. Outdoor air to unit
5. Condensate drain

Duct outlets, model L

Inner diameter of female outlet collar \varnothing 125mm

1. Exhaust air out
2. Outdoor air to unit
3. Supply air to dwelling
4. Extract air from dwelling to unit
5. Condensate drain

TECHNICAL DATA

Specification	DV96
Suitable for dwellings up to m ²	130
Max air flow (m ³ /h) / (l/s) at 100Pa.	320 / 89
Thermal efficiency (%)	Up to 90
Heat exchanger	Cross-Counter-Flow (Plastic)
Fans	EC
Summer by-pass damper	100% automatic
Integral humidity sensor (RH %)	0 - 100
Frost protection (optional)	Smart Frost
Controls (optional)	Digital - 4 Profiles, 100% adjustable Manual - 4 Speed controller, adjustable
Connection to BMS	Modbus / KNX optional
Mounting	Wall / Ceiling
Sound power level @3m (dB(A))	48
Duct diameter (mm)	125 (4 ports)
Condensate discharge (ins)	3/4 BSP
Electrical supply	230V / 1ph / 50Hz
Max. power consumption (W)	162
Filter Class	2 x G4 (ISO Coarse > 75%), 1 x F7 (ISO ePM1)
Built-in electric post-heater (optional) (W)	900
Protection class	IP34
Casing insulation (mm)	20
Weight (kg)	53
Dimensions (L x D x H) (mm)	600 x 430 x 545
Duct entry	Top Entry
Versions available Right Hand: With optional electric post-heater: Left Hand: With optional electric post-heater:	 90000576 90000576EPH 90000577 90000577EPH

ACCESSORIES

Adroit Digital Controller

Wall mounted, LCD display with four 100% independently user adjustable air flow profiles (Home, Away, Boost, Fireplace). A range of indoor parameters ie: air flow rates, temperature, humidity, by-pass, time clock settings, CO₂ sensor, filter alert are adjustable to suit your indoor environment. Internet connectivity via Adroit 'Cloud' for control at home or on the go.

Adroit Speed Controller

Wall mounted, four speed (independently adjustable) rotary switch air flow controller.

Visit airflow.com for Adroit controls options data sheet.

Accessory	Product Code
Adroit Digital Controller	90000610
Adroit Relative Humidity Transmitter	90000612
Adroit CO ₂ Transmitter	90000613
Adroit Speed Controller	9041219
Ceiling Mounting Plate	90000716
Attic Roof Penetration Plate	90000718
Additional 900W Heater for DV96 (R)	90000614
Additional 900W Heater for DV96 (L)	90000615
Filter Set (2 x G4 ISO Coarse > 75%), 1 x F7 (ISOePM1)	90000375
Boost Switch	90000542
KNX-Converter	90000723

CERTIFICATION

The DV96 Adroit meets requirements set out by the Energy Related Products (ErP) Directive 2016, achieving an A rating. You can find out more about the ErP Directive at: www.airflow.com

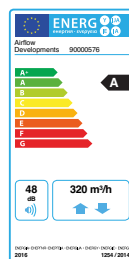

The DV96 was tested and has achieved Passive House Approval by the Passive House Institute when equipped with the optional Electric Post-heater.



DV96 Adroit

Adroit Line Top Entry -
Up to 345 m³/h air volume

The DV96 Adroit is fitted with a unique triple air filter facility. It comes with two G4 (ISO Coarse > 75%) and one F7 (ISOePM1) filters, which provides additional air filtration by prevent particles as small as pollen from entering the premises. This is of particular benefit to those that suffer from asthma or hay fever and other respiratory conditions.

You can control your Adroit unit via internet or local network using laptop, smartphone, tablet etc. As an option there is a digital controller available that enables you to adjust the ventilation levels of your Adroit unit as well as setting the user profiles. The controller provides significant information to the user regarding the performance of their Adroit system including; adjusting the ventilation levels, filter maintenance, separate fan control, faults in the system and commissioning the system. You can also use an optional manual controller which provides simple control by switching ventilation profiles.

Through combining your unit with additional humidity and CO₂ sensors, you are able to achieve on-demand ventilation for the property. This is possible, as due to changes to humidity and CO₂ levels that occur through changes in occupancy or usage, the ventilation will boost or reduce to match demand; without the need of manual intervention.

The DV96 can be integrated with a Building Management System (BMS) via a Modbus connection or KNX, which allows the user to monitor and control the unit's functions via a central control system.

NEW SMART FROST PROTECTION

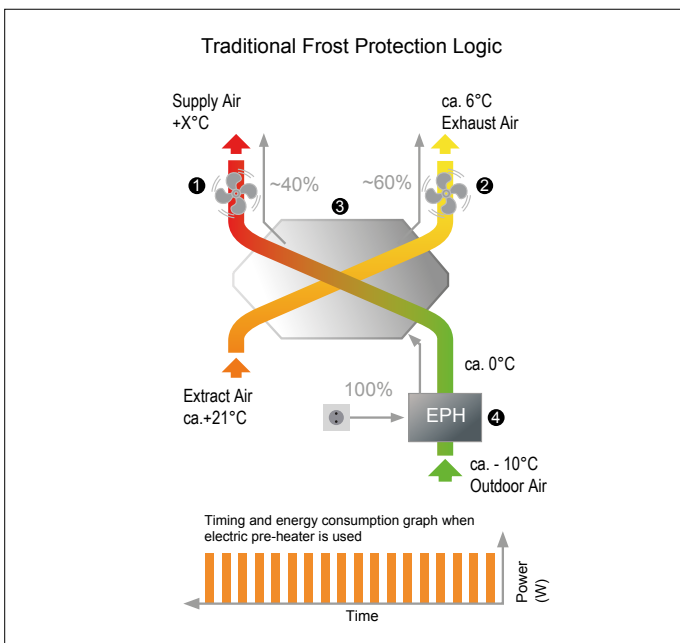

On the traditional frost protection method, the outdoor air is pre-heated before passing through the heat exchanger. This way the unit could still provide balanced ventilation even when the frost protection was on. However, the electric heater kicks in intermittently hence consumes more energy than needed.

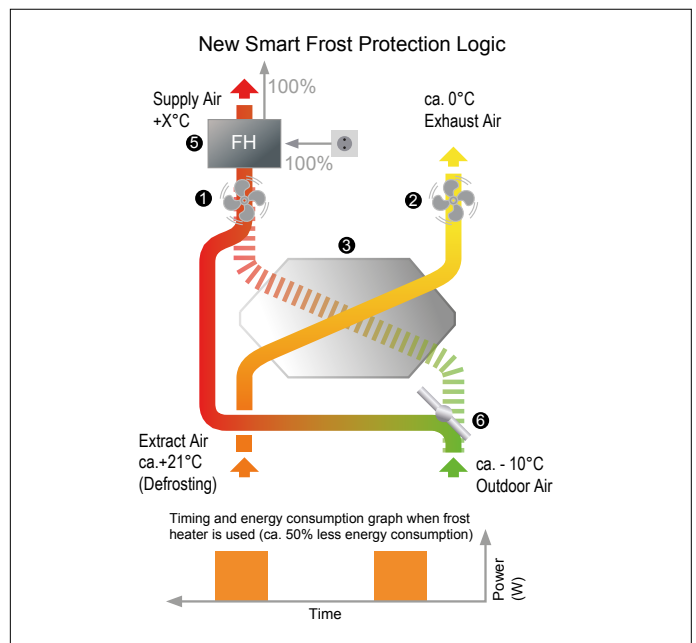

The new Smart Frost Protection method works in a more energy efficient manner which constantly monitors the heat exchanger conditions and uses the frost heater only when necessary. This significantly reduces the energy consumption and provides more heat recovery throughout the winter season.

- ① Supply air fan
- ② Exhaust air fan
- ③ Heat exchanger
- ④ Electric pre-heater
- ⑤ Frost heater
- ⑥ Electric bypass damper

TRIPLE FILTER DESIGN

The majority of the MVHR units in the U.K incorporate G3 or G4 (ISO Coarse > 75%) coarse filters on the extract / supply air side. These filters catch only coarse particles such as insects and leaves to protect the heat exchanger.

F7 (ISOePM1) fine filters on the other hand are highly efficient, catch invisible particles such as pollen, spore, bacterium and **dust entering the lungs**.

Adroit units are the only MVHR units which incorporate triple filter design combining G4 (ISO Coarse > 75%) coarse filters with the F7 (ISOePM1) fine filter. This significantly improves the indoor air quality and lowers your maintenance costs.



100% AUTOMATIC BYPASS

The unit is equipped with an automatic, 100% bypass which totally isolates the heat exchanger so that no air passes through it. This prevents overheating the dwelling in the summer season.

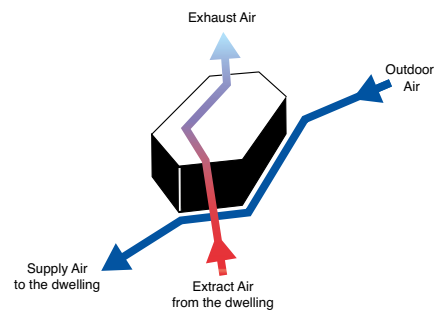

CONTROLS

Ideal indoor air quality is achieved by automatically **adjusted ventilation**

Adroit DV96 is controlled via 4 ventilation profiles controls providing the following features:

- **4 ventilation profiles**, 100% adjustable
- **Internet** connection available
- **Automatic boost function** with delay timer
- **Filter maintenance reminder** via counter clock (standard)
- **Heater control** for optional post-heater
- **Connection to BMS** via LON or KNX
- **Self diagnostic** via fault signal relay
- **On-demand control** via humidity and CO₂ sensors
- **Separate fan control** for ease of commissioning
- **Weekly ventilation programming** allows users to pre-set the ventilation levels scheduled for different days
- **Indoor temperature control** based on extract air temperature or supply air temperature

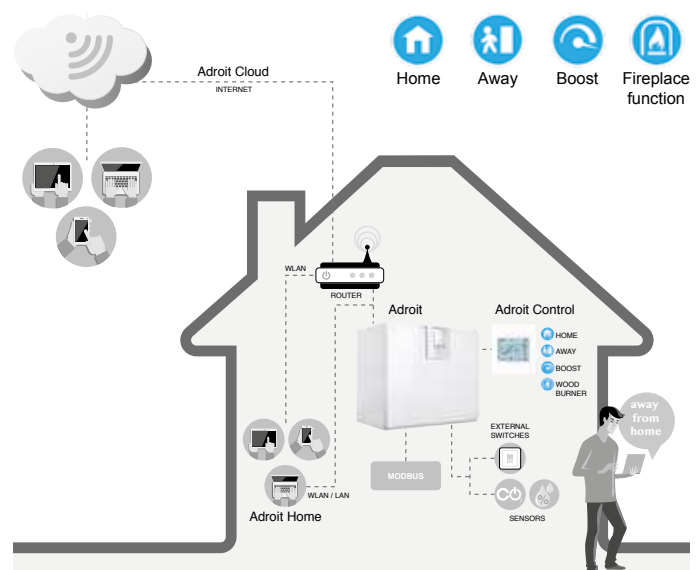

DV110 Adroit

Adroit Line Top Entry -
Up to 385 m³/h air volume



KEY FEATURES

- For use in dwellings up to 170m² *
- Up to 90% thermal efficiency and low SFP
- 'A' energy rating
- Internet control by smart phone, tablet or PC
- Triple filter design with F7 pollen filter
- Automatic, 100% summer by-pass
- Integral Humidity Sensor
- Galvanised steel, double-skin casing
- BMS (Modbus / KNX) connection
- Optional LCD digital controller with four independent environmental profiles
- Optional manual four speed controller
- Auto cut-out switch for extra safety
- Optional built-in Electric Post-heater
- Optional smart frost protection
- Complies with Building Regulations and Passive House certified
- 5 year warranty+

DV110 ADROIT

With its powerful air volume capacity and high thermal efficiency the DV110 Adroit is suitable for medium sized family homes. Control your indoor air environment at home or on the go via the Adroit 'Cloud' internet control by smart phone, tablet or PC.

With the triple filter design with an F7 pollen filter, the DV110 Adroit provides additional protection against invisible, harmful particles and creates an ultra hygienic environment.

The automatic, 100% summer by-pass facility isolates the heat recovery function and helps to effectively maintain a temperate indoor air climate during the summer months.

The unit includes an easily removable, plastic heat exchanger and may be equipped with a range of optional accessories for higher performance.

PERFORMANCE

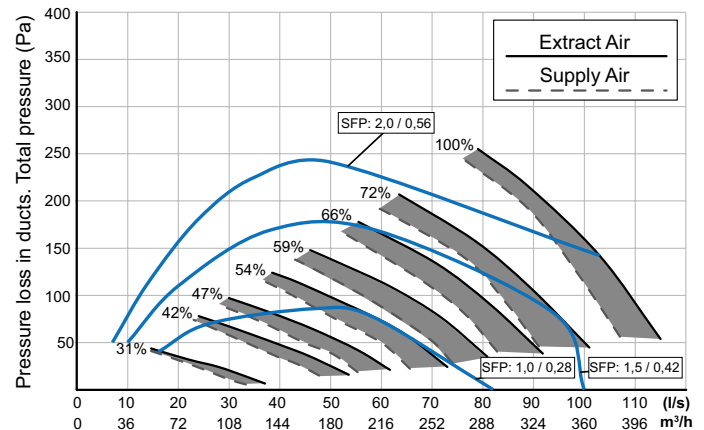

* Guidance only. Dependant upon system pressure.

DIMENSIONS

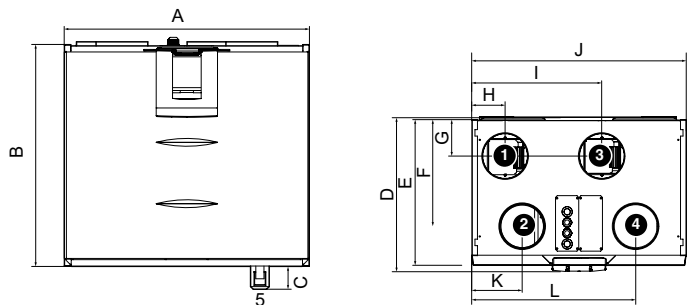

+ excludes motors. Motor warranty one year from date of purchase

Model	A	B	C	D	E	F	G	H	I	J	K	L
DV110	638	678	42	472	455	325	111	112	390	638	160	478

Duct outlets, model R

Inner diameter of female outlet collar \varnothing 160mm

1. Supply air to dwelling
2. Extract air from dwelling to unit
3. Exhaust air out
4. Outdoor air to unit
5. Condensate drain

Duct outlets, model L

Inner diameter of female outlet collar \varnothing 160mm

1. Exhaust air out
2. Outdoor air to unit
3. Supply air to dwelling
4. Extract air from dwelling to unit
5. Condensate drain

TECHNICAL DATA

Specification	DV110
Suitable for dwellings up to m ²	170
Max air flow (m ³ /h) / (l/s) at 100Pa.	370 / 103
Thermal efficiency (%)	Up to 90
Heat exchanger	Cross-Counter-Flow (Plastic)
Fans	EC
Summer by-pass damper	100% automatic
Integral humidity sensor (RH %)	0 - 100
Frost protection (optional)	Smart Frost
Controls (optional)	Digital - 4 Profiles, 100% adjustable
Connection to BMS	Modbus / KNX optional
Mounting	Wall / Ceiling
Sound power level @3m (dB(A))	58
Duct diameter (mm)	160 (4 ports)
Condensate discharge (ins)	3/4 BSP
Electrical supply	230V / 1ph / 50Hz
Max. power consumption (W)	200
Filter Class	2 x G4 (ISO Coarse > 75%), 1 x F7 (ISO ePM1)
Built-in electric post-heater (optional) (W)	900
Protection class	IP34
Casing insulation (mm)	20
Weight (kg)	64
Dimensions (L x D x H) (mm)	638 x 472 x 678
Duct entry	Top Entry
Versions available	
Right Hand:	90000578
With optional electric post-heater:	90000578EPH
Left Hand:	90000579
With optional electric post-heater:	90000579EPH

ACCESSORIES

Adroit Digital Controller

Wall mounted, LCD display with four 100% independently user adjustable air flow profiles (Home, Away, Boost, Fireplace). A range of indoor parameters ie: air flow rates, temperature, humidity, by-pass, time clock settings, CO₂ sensor, filter alert are adjustable to suit your indoor environment. Internet connectivity via Adroit 'Cloud' for control at home or on the go.

Adroit Speed Controller

Wall mounted, four speed (independently adjustable) rotary switch air flow controller.

Visit airflow.com for Adroit controls options data sheet.

Accessory	Product Code
Adroit Digital Controller	90000610
Adroit Relative Humidity Transmitter	90000612
Adroit CO ₂ Transmitter	90000613
Adroit Speed Controller	9041219
Ceiling Mounting Plate	90000717
Attic Roof Penetration Plate	90000719
Additional 900W Heater for DV96 (R)	90000616
Additional 900W Heater for DV96 (L)	90000617
Filter Set (2 x G4 ISO Coarse > 75%), 1 x F7 (ISOePM1)	90000378
Boost Switch	90000542
KNX-Converter	90000723

CERTIFICATION

The DV110 Adroit meets requirements set out by the Energy Related Products (ErP) Directive 2016, achieving an A rating. You can find out more about the ErP Directive at: www.airflow.com

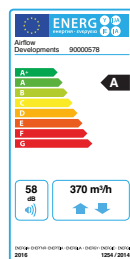

The DV110 was tested and has achieved Passive House Approval by the Passive House Institute when equipped with the optional Electric Post-heater.



DV110 Adroit

Adroit Line Top Entry -
Up to 385 m³/h air volume

The DV110 Adroit is fitted with a unique triple air filter facility. It comes with two G4 (ISO Coarse > 75%) and one F7 (ISOePM1) filters, which provides additional air filtration by prevent particles as small as pollen from entering the premises. This is of particular benefit to those that suffer from asthma or hay fever and other respiratory conditions.

You can control your Adroit unit via internet or local network using laptop, smartphone, tablet etc. As an option there is a digital controller available that enables you to adjust the ventilation levels of your Adroit unit as well as setting the user profiles. The controller provides significant information to the user regarding the performance of their Adroit system including; adjusting the ventilation levels, filter maintenance, separate fan control, faults in the system and commissioning the system. You can also use an optional manual controller which provides simple control by switching ventilation profiles.

Through combining your unit with additional humidity and CO₂ sensors, you are able to achieve on-demand ventilation for the property. This is possible, as due to changes to humidity and CO₂ levels that occur through changes in occupancy or usage, the ventilation will boost or reduce to match demand; without the need of manual intervention.

The DV110 can be integrated with a Building Management System (BMS) via a Modbus connection or KNX, which allows the user to monitor and control the unit's functions via a central control system.

NEW SMART FROST PROTECTION

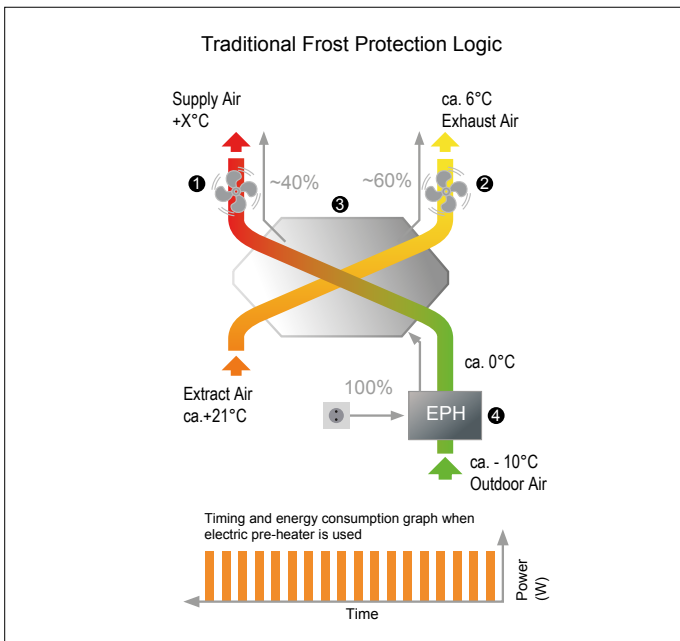

On the traditional frost protection method, the outdoor air is pre-heated before passing through the heat exchanger. This way the unit could still provide balanced ventilation even when the frost protection was on. However, the electric heater kicks in intermittently hence consumes more energy than needed.

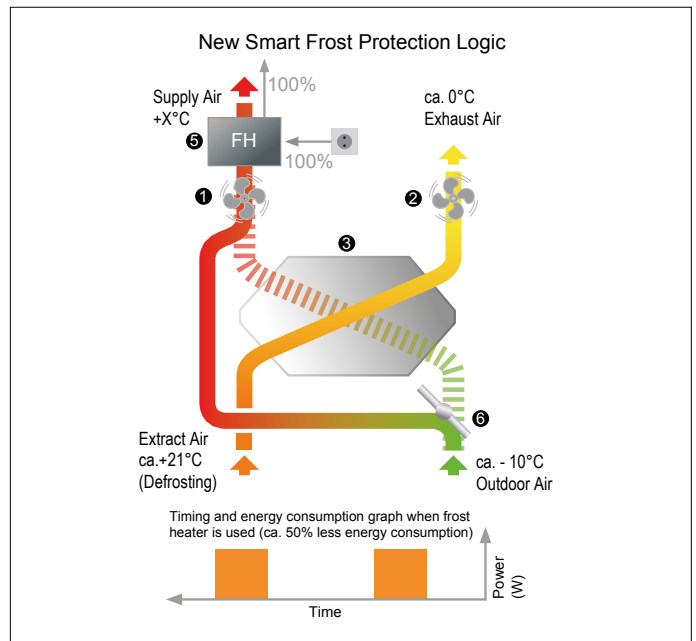

The new Smart Frost Protection method works in a more energy efficient manner which constantly monitors the heat exchanger conditions and uses the frost heater only when necessary. This significantly reduces the energy consumption and provides more heat recovery throughout the winter season.

- 1 Supply air fan
- 2 Exhaust air fan
- 3 Heat exchanger
- 4 Electric pre-heater
- 5 Frost heater
- 6 Electric bypass damper

TRIPLE FILTER DESIGN

The majority of the MVHR units in the U.K incorporate G3 or G4 (ISO Coarse > 75%) coarse filters on the extract / supply air side. These filters catch only coarse particles such as insects and leaves to protect the heat exchanger.

F7 (ISOePM1) fine filters on the other hand are highly efficient, catch invisible particles such as pollen, spore, bacterium and **dust entering the lungs**.

Adroit units are the only MVHR units which incorporate triple filter design combining G4 (ISO Coarse > 75%) coarse filters with the F7 (ISOePM1) fine filter. This significantly improves the indoor air quality and lowers your maintenance costs.



100% AUTOMATIC BYPASS

The unit is equipped with an automatic, 100% bypass which totally isolates the heat exchanger so that no air passes through it. This prevents overheating the dwelling in the summer season.

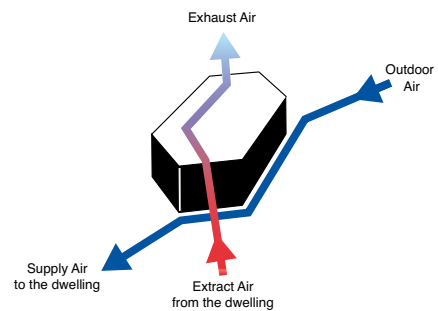

CONTROLS

Ideal indoor air quality is achieved by automatically **adjusted ventilation**

Adroit DV110 is controlled via 4 ventilation profiles controls providing the following features:

- **4 ventilation profiles**, 100% adjustable
- **Internet** connection available
- **Automatic boost function** with delay timer
- **Filter maintenance reminder** via counter clock (standard)
- **Heater control** for optional post-heater
- **Connection to BMS** via LON or KNX
- **Self diagnostic** via fault signal relay
- **On-demand control** via humidity and CO₂ sensors
- **Separate fan control** for ease of commissioning
- **Weekly ventilation programming** allows users to pre-set the ventilation levels scheduled for different days
- **Indoor temperature control** based on extract air temperature or supply air temperature

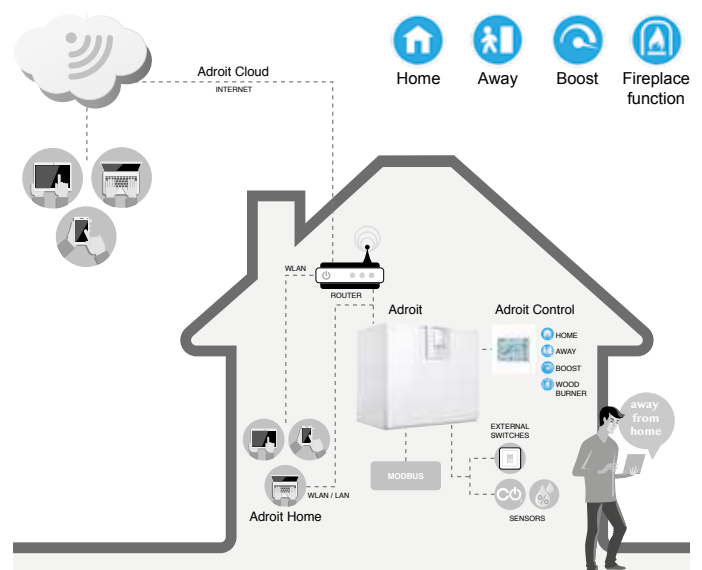

DV145 Adroit

Adroit Line Top Entry -
Up to 565 m³/h air volume



KEY FEATURES

- For use in dwellings up to 250m² *
- Up to 90% thermal efficiency and low SFP
- 'A' energy rating
- Internet control by smart phone, tablet or PC
- Triple filter design with F7 pollen filter
- Automatic, 100% summer by-pass
- Integral Humidity Sensor
- Galvanised steel, double-skin casing
- BMS (Modbus / KNX) connection
- Optional LCD digital controller with four independent environmental profiles
- Optional manual four speed controller
- Auto cut-out switch for extra safety
- Optional built-in Electric Post-heater
- Optional smart frost protection
- Complies with Building Regulations and Passive House certified
- 5 year warranty+

DV145 ADROIT

With its powerful air volume capacity and high thermal efficiency the DV145 Adroit is suitable for larger family homes. Control your indoor air environment at home or on the go via the Adroit 'Cloud' internet control by smart phone, tablet or PC.

With the triple filter design with an F7 pollen filter, the DV145 Adroit provides additional protection against invisible, harmful particles and creates an ultra hygienic environment.

The automatic, 100% summer by-pass facility isolates the heat recovery function and helps to effectively maintain a temperate indoor air climate during the summer months.

The unit includes an easily removable, plastic heat exchanger and may be equipped with a range of optional accessories for higher performance.

PERFORMANCE

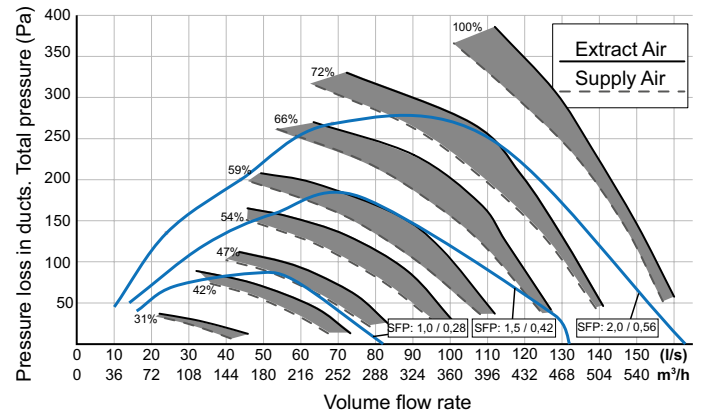

* Guidance only. Dependant upon system pressure.

Duct outlets, model R

Inner diameter of female outlet collar \varnothing 160mm

1. Supply air to dwelling
2. Extract air from dwelling to unit
3. Exhaust air out
4. Outdoor air to unit
5. Condensate drain

Duct outlets, model L

Inner diameter of female outlet collar \varnothing 160mm

1. Exhaust air out
2. Outdoor air to unit
3. Supply air to dwelling
4. Extract air from dwelling to unit
5. Condensate drain

DIMENSIONS

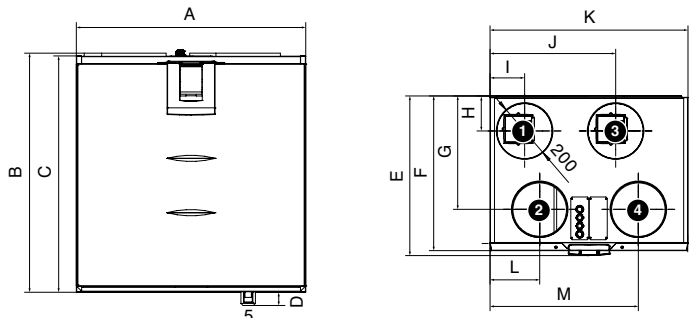

+ excludes motors. Motor warranty one year from date of purchase

Model	A	B	C	D	E	F	G	H	I	J	K	L	M
DV145	717	748	739	43	578	560	411	127	125	455	717	180	537

TECHNICAL DATA

Specification	DV145
Suitable for dwellings up to m ²	250
Max air flow (m ³ /h) / (l/s) at 100Pa.	542 / 151
Thermal efficiency (%)	Up to 90
Heat exchanger	Cross-Counter-Flow (Plastic)
Fans	EC
Summer by-pass damper	100% automatic
Integral humidity sensor (RH %)	0 - 100
Frost protection (optional)	Smart Frost
Controls (optional)	Digital - 4 Profiles, 100% adjustable Manual - 4 Speed controller, adjustable
Connection to BMS	Modbus / KNX optional
Mounting	Wall / Floor
Sound power level @3m (dB(A))	50
Duct diameter (mm)	200 (4 ports)
Condensate discharge (ins)	3/4 BSP
Electrical supply	230 V / 1 ph / 50 Hz
Max. power consumption (W)	310
Filter Class	2 x G4 (ISO Coarse > 75%), 1 x F7 (ISO ePM1)
Built-in electric post-heater (optional) (W)	2400 (900 + 1500)
Protection class	IP34
Casing insulation (mm)	20
Weight (kg)	88
Dimensions (L x D x H) (mm)	717 x 578 x 748
Duct entry	Top Entry
Versions available	
Right Hand:	90000580
With optional electric post-heater:	90000580EPH
Left Hand:	90000581
With optional electric post-heater:	90000581EPH

ACCESSORIES

Adroit Digital Controller

Wall mounted, LCD display with four 100% independently user adjustable air flow profiles (Home, Away, Boost, Fireplace). A range of indoor parameters ie: air flow rates, temperature, humidity, by-pass, time clock settings, CO₂ sensor, filter alert are adjustable to suit your indoor environment. Internet connectivity via Adroit 'Cloud' for control at home or on the go.

Adroit Speed Controller

Wall mounted, four speed (independently adjustable) rotary switch air flow controller.

Visit airflow.com for Adroit controls options data sheet.

Accessory	Product Code
Adroit Digital Controller	90000610
Adroit Relative Humidity Transmitter	90000612
Adroit CO ₂ Transmitter	90000613
Adroit Speed Controller	9041219
Floor Rack	90000722
Attic Roof Penetration Plate	90000720
Additional 900W + 1500W Heater for DV145 (R)	90000624
Additional 900W + 1500W Heater for DV145 (L)	90000625
Filter Set (2 x G4 ISO Coarse > 75%), 1 x F7 (ISOePM1)	90000376
Boost Switch	90000542
KNX-Converter	90000723

CERTIFICATION

The DV145 Adroit meets requirements set out by the Energy Related Products (ErP) Directive 2016, achieving an A rating. You can find out more about the ErP Directive at: www.airflow.com

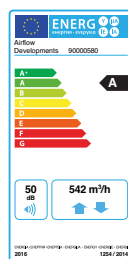

The DV145 was tested and has achieved Passive House Approval by the Passive House Institute when equipped with the optional Electric Post-heater.



DV145 Adroit

Adroit Line Top Entry -
Up to 565 m³/h air volume

The DV145 Adroit is fitted with a unique triple air filter facility. It comes with two G4 (ISO Coarse > 75%) and one F7 (ISOePM1) filters, which provides additional air filtration by prevent particles as small as pollen from entering the premises. This is of particular benefit to those that suffer from asthma or hay fever and other respiratory conditions.

You can control your Adroit unit via internet or local network using laptop, smartphone, tablet etc. As an option there is a digital controller available that enables you to adjust the ventilation levels of your Adroit unit as well as setting the user profiles. The controller provides significant information to the user regarding the performance of their Adroit system including; adjusting the ventilation levels, filter maintenance, separate fan control, faults in the system and commissioning the system. You can also use an optional manual controller which provides simple control by switching ventilation profiles.

Through combining your unit with additional humidity and CO₂ sensors, you are able to achieve on-demand ventilation for the property. This is possible, as due to changes to humidity and CO₂ levels that occur through changes in occupancy or usage, the ventilation will boost or reduce to match demand; without the need of manual intervention.

The DV145 can be integrated with a Building Management System (BMS) via a Modbus connection or KNX, which allows the user to monitor and control the unit's functions via a central control system.

NEW SMART FROST PROTECTION

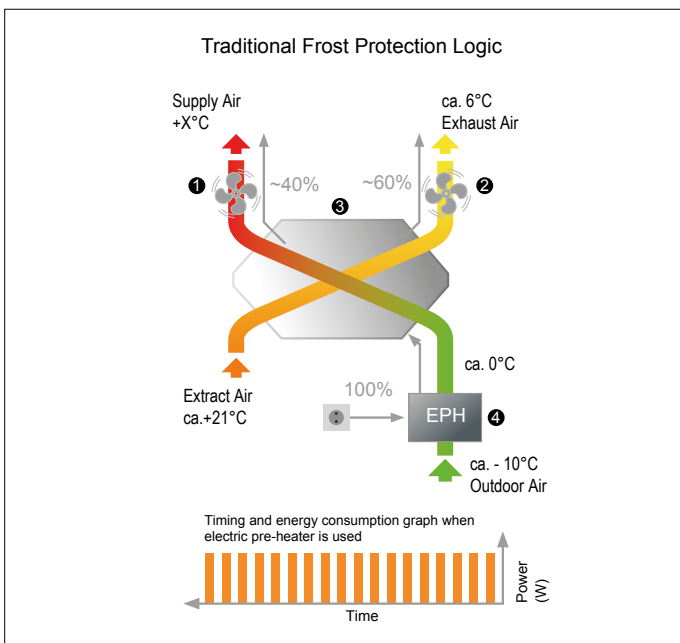

On the traditional frost protection method, the outdoor air is pre-heated before passing through the heat exchanger. This way the unit could still provide balanced ventilation even when the frost protection was on. However, the electric heater kicks in intermittently hence consumes more energy than needed.

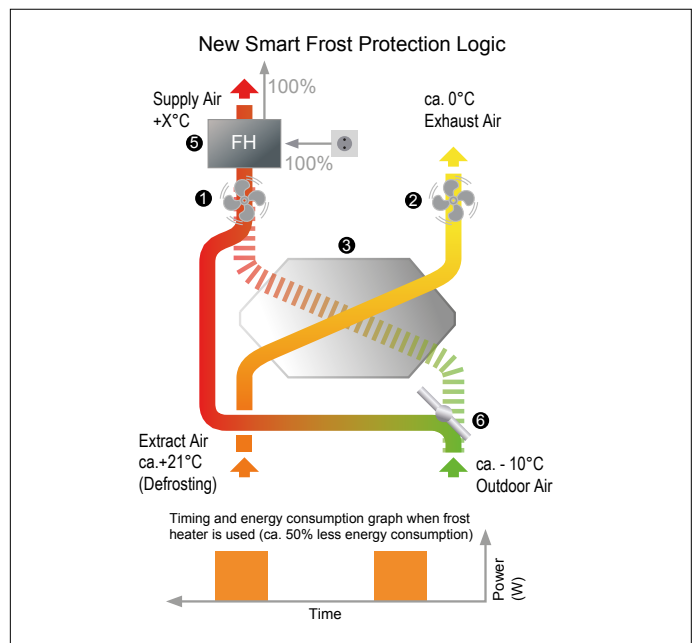

The new Smart Frost Protection method works in a more energy efficient manner which constantly monitors the heat exchanger conditions and uses the frost heater only when necessary. This significantly reduces the energy consumption and provides more heat recovery throughout the winter season.

- 1 Supply air fan
- 2 Exhaust air fan
- 3 Heat exchanger
- 4 Electric pre-heater
- 5 Frost heater
- 6 Electric bypass damper

TRIPLE FILTER DESIGN

The majority of the MVHR units in the U.K incorporate G3 or G4 (ISO Coarse > 75%) coarse filters on the extract / supply air side. These filters catch only coarse particles such as insects and leaves to protect the heat exchanger.

F7 (ISOePM1) fine filters on the other hand are highly efficient, catch invisible particles such as pollen, spore, bacterium and **dust entering the lungs**.

Adroit units are the only MVHR units which incorporate triple filter design combining G4 (ISO Coarse > 75%) coarse filters with the F7 (ISOePM1) fine filter. This significantly improves the indoor air quality and lowers your maintenance costs.



100% AUTOMATIC BYPASS

The unit is equipped with an automatic, 100% bypass which totally isolates the heat exchanger so that no air passes through it. This prevents overheating the dwelling in the summer season.

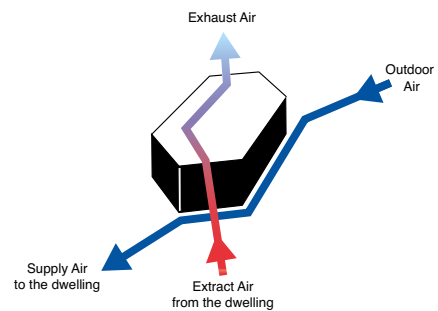

CONTROLS

Ideal indoor air quality is achieved by automatically **adjusted ventilation**

Adroit DV145 is controlled via 4 ventilation profiles controls providing the following features:

- **4 ventilation profiles**, 100% adjustable
- **Internet** connection available
- **Automatic boost function** with delay timer
- **Filter maintenance reminder** via counter clock (standard)
- **Heater control** for optional post-heater
- **Connection to BMS** via LON or KNX
- **Self diagnostic** via fault signal relay
- **On-demand control** via humidity and CO₂ sensors
- **Separate fan control** for ease of commissioning
- **Weekly ventilation programming** allows users to pre-set the ventilation levels scheduled for different days
- **Indoor temperature control** based on extract air temperature or supply air temperature

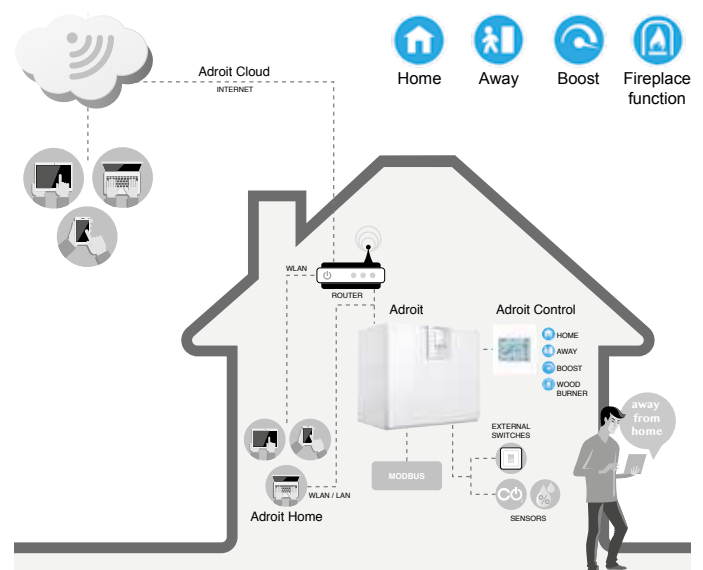

DV245 Adroit

Adroit Line Top Entry -
Up to 950 m³/h air volume



KEY FEATURES

- For use in dwellings up to 400 m²*
- Up to 90% thermal efficiency and low SFP
- 'A' energy rating
- Internet control by smart phone, tablet or PC
- Triple filter design with F7 pollen filter
- Automatic, 100% summer by-pass
- Integral Humidity Sensor
- Galvanised steel, double-skin casing
- BMS (Modbus / KNX) connection
- Optional LCD digital controller with four independent environmental profiles
- Optional manual four speed controller
- Auto cut-out switch for extra safety
- Optional built-in Electric Post-heater
- Optional smart frost protection
- Complies with Building Regulations and Passive House certified
- 5 year warranty+

DV245 ADROIT

With its powerful air volume capacity and high thermal efficiency the DV245 Adroit is suitable for large family houses. Control your indoor air environment at home or on the go via the Adroit 'Cloud' internet control by smart phone, tablet or PC.

With the triple filter design with an F7 pollen filter, the DV245 Adroit provides additional protection against invisible, harmful particles and creates an ultra hygienic environment.

The automatic, 100% summer by-pass facility isolates the heat recovery function and helps to effectively maintain a temperate indoor air climate during the summer months.

The unit includes an easily removable, aluminium heat exchanger and may be equipped with a range of optional accessories for higher performance.

Duct outlets, model R

Inner diameter of female outlet collar \varnothing 250mm

1. Supply air to dwelling
2. Extract air from dwelling to unit
3. Exhaust air out
4. Outdoor air to unit
5. Condensate drain

Duct outlets, model L

Inner diameter of female outlet collar \varnothing 250mm

1. Exhaust air out
2. Outdoor air to unit
3. Supply air to dwelling
4. Extract air from dwelling to unit
5. Condensate drain

+ excludes motors. Motor warranty one year from date of purchase

PERFORMANCE

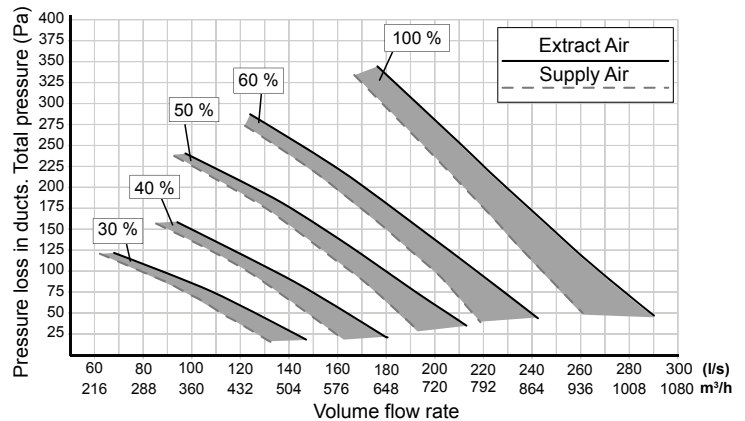

* Guidance only. Dependant upon system pressure.

DIMENSIONS

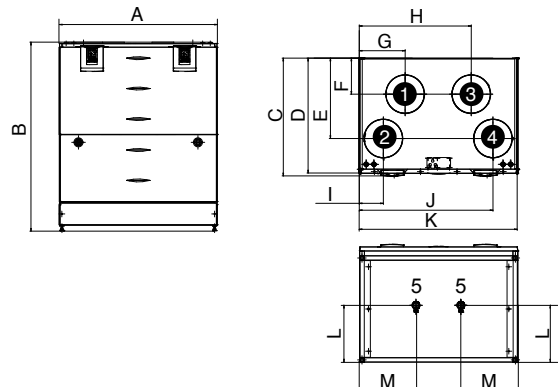

Model	A	B	C	D	E	F	G
DV245	1038	1226-1241	773	754	528	237	301
	H	I	J	K	L	M	
	735	158	878	1038	373	371	

TECHNICAL DATA

Specification	DV245
Suitable for dwellings up to m ²	400
Max air flow (m ³ /h) / (l/s) at 100Pa.	929 / 258
Thermal efficiency (%)	Up to 90
Heat exchanger	Cross-Counter-Flow (Aluminium)
Fans	EC
Summer by-pass damper	100% automatic
Integral humidity sensor (RH %)	0 - 100
Frost protection (optional)	Smart Frost
Controls (optional)	Digital - 4 Profiles, 100% adjustable Manual - 4 Speed controller, adjustable
Connection to BMS	Modbus / KNX optional
Mounting	Floor
Sound power level @3m (dB(A))	53
Duct diameter (mm)	250 (4 ports)
Condensate discharge (ins)	3/4 BSP
Electrical supply	230 V / 1 ph / 50 Hz
Max. power consumption (W)	314
Filter Class	2 x G4 (ISO Coarse > 75%), 1 x F7 (ISO ePM1)
Built-in electric post-heater (optional) (W)	3000 (2 x 1500)
Protection class	IP34
Casing insulation (mm)	50
Weight (kg)	200
Dimensions (L x D x H) (mm)	1038 x 773 x 1226-1241
Duct entry	Top Entry
Versions available	
Right Hand:	90000582
With optional electric post-heater:	90000582EPH
Left Hand:	90000583
With optional electric post-heater:	90000583EPH

ACCESSORIES

Adroit Digital Controller

Wall mounted, LCD display with four 100% independently user adjustable air flow profiles (Home, Away, Boost, Fireplace). A range of indoor parameters ie: air flow rates, temperature, humidity, by-pass, time clock settings, CO₂ sensor, filter alert are adjustable to suit your indoor environment. Internet connectivity via Adroit 'Cloud' for control at home or on the go.

Adroit Speed Controller

Wall mounted, four speed (independently adjustable) rotary switch air flow controller.

Visit airflow.com for Adroit controls options data sheet.

Accessory	Product Code
Adroit Digital Controller	90000610
Adroit Relative Humidity Transmitter	90000612
Adroit CO ₂ Transmitter	90000613
Adroit Speed Controller (manual)	9041219
2 x Additional 1500W Heaters for DV245 (R + L)	90000630
Filter Set (2 x G4 ISO Coarse > 75%), 1 x F7 (ISOePM1)	90000611
Boost Switch	90000542
KNX-Converter	90000723

CERTIFICATION

The DV245 Adroit meets requirements set out by the Energy Related Products (ErP) Directive 2016, achieving an A rating. You can find out more about the ErP Directive at: www.airflow.com

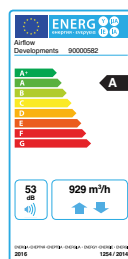

The DV245 was tested and has achieved Passive House Approval by the Passive House Institute when equipped with the optional Electric Post-heater.



DV245 Adroit

Adroit Line Top Entry -
Up to 950 m³/h air volume

The DV245 Adroit is fitted with a unique triple air filter facility. It comes with two G4 (ISO Coarse > 75%) and one F7 (ISOePM1) filters, which provides additional air filtration by prevent particles as small as pollen from entering the premises. This is of particular benefit to those that suffer from asthma or hay fever and other respiratory conditions.

You can control your Adroit unit via internet or local network using laptop, smartphone, tablet etc. As an option there is a digital controller available that enables you to adjust the ventilation levels of your Adroit unit as well as setting the user profiles. The controller provides significant information to the user regarding the performance of their Adroit system including; adjusting the ventilation levels, filter maintenance, separate fan control, faults in the system and commissioning the system. You can also use an optional manual controller which provides simple control by switching ventilation profiles.

Through combining your unit with additional humidity and CO₂ sensors, you are able to achieve on-demand ventilation for the property. This is possible, as due to changes to humidity and CO₂ levels that occur through changes in occupancy or usage, the ventilation will boost or reduce to match demand; without the need of manual intervention.

The DV245 can be integrated with a Building Management System (BMS) via a Modbus connection or KNX, which allows the user to monitor and control the unit's functions via a central control system.

NEW SMART FROST PROTECTION

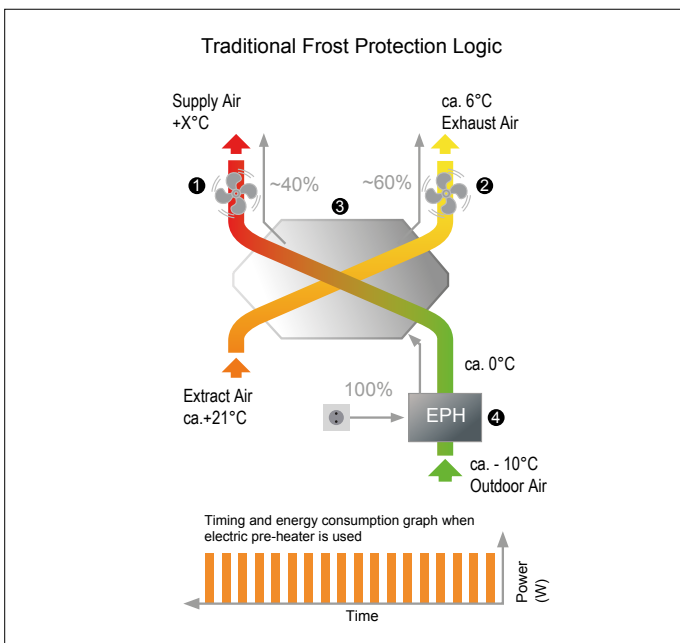

On the traditional frost protection method, the outdoor air is pre-heated before passing through the heat exchanger. This way the unit could still provide balanced ventilation even when the frost protection was on. However, the electric heater kicks in intermittently hence consumes more energy than needed.

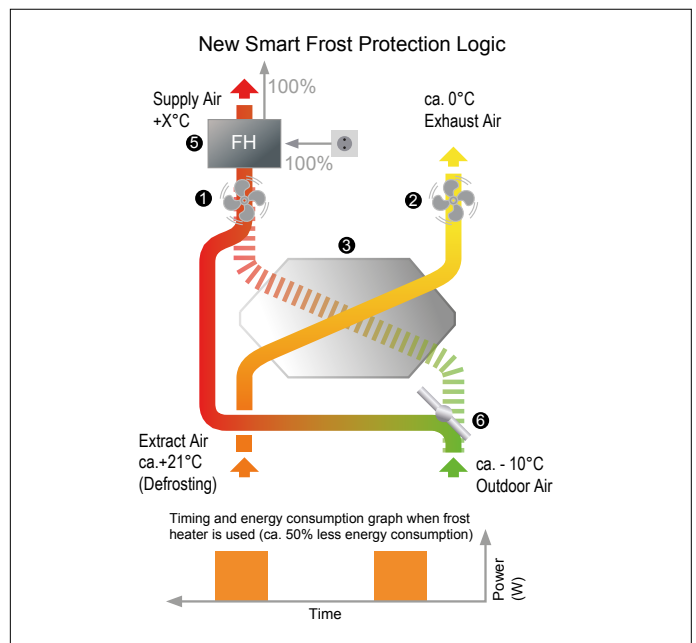

The new Smart Frost Protection method works in a more energy efficient manner which constantly monitors the heat exchanger conditions and uses the frost heater only when necessary. This significantly reduces the energy consumption and provides more heat recovery throughout the winter season.

- ① Supply air fan
- ② Exhaust air fan
- ③ Heat exchanger
- ④ Electric pre-heater
- ⑤ Frost heater
- ⑥ Electric bypass damper

TRIPLE FILTER DESIGN

The majority of the MVHR units in the U.K incorporate G3 or G4 (ISO Coarse > 75%) coarse filters on the extract / supply air side. These filters catch only coarse particles such as insects and leaves to protect the heat exchanger.

F7 (ISOePM1) fine filters on the other hand are highly efficient, catch invisible particles such as pollen, spore, bacterium and **dust entering the lungs**.

Adroit units are the only MVHR units which incorporate triple filter design combining G4 (ISO Coarse > 75%) coarse filters with the F7 (ISOePM1) fine filter. This significantly improves the indoor air quality and lowers your maintenance costs.



100% AUTOMATIC BYPASS

The unit is equipped with an automatic, 100% bypass which totally isolates the heat exchanger so that no air passes through it. This prevents overheating the dwelling in the summer season.

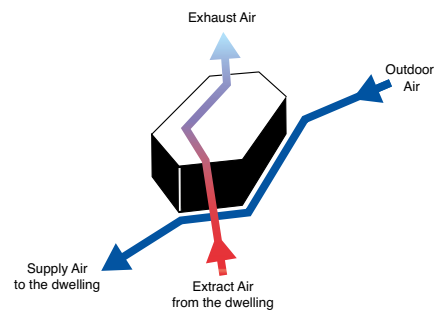

CONTROLS

Ideal indoor air quality is achieved by automatically **adjusted ventilation**

Adroit DV245 is controlled via 4 ventilation profiles controls providing the following features:

- **4 ventilation profiles**, 100% adjustable
- **Internet** connection available
- **Automatic boost function** with delay timer
- **Filter maintenance reminder** via counter clock (standard)
- **Heater control** for optional post-heater
- **Connection to BMS** via LON or KNX
- **Self diagnostic** via fault signal relay
- **On-demand control** via humidity and CO₂ sensors
- **Separate fan control** for ease of commissioning
- **Weekly ventilation programming** allows users to pre-set the ventilation levels scheduled for different days
- **Indoor temperature control** based on extract air temperature or supply air temperature

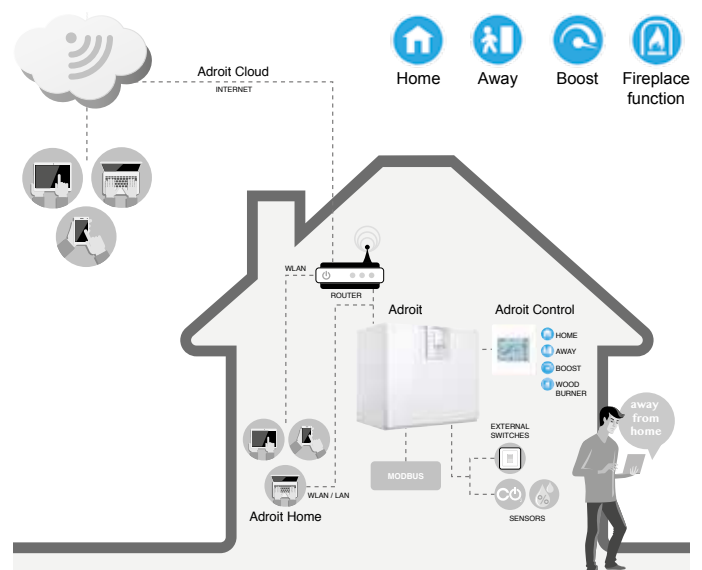

DV50 Adroit

Adroit Line Top Entry -
Up to 195 m³/h air volume



KEY FEATURES

- For use in dwellings up to 80m² *
- Up to 90% thermal efficiency and low SFP
- 'A' energy rating
- Internet control by smart phone, tablet or PC
- Triple filter design with F7 pollen filter
- Automatic, 100% summer by-pass
- Integral Humidity Sensor
- Galvanised steel, double-skin casing
- BMS (Modbus / KNX) connection
- Optional LCD digital controller with four independent environmental profiles
- Optional manual four speed controller
- Auto cut-out switch for extra safety
- Optional built-in Electric Post-heater
- Optional smart frost protection
- Complies with Building Regulations and Passive House certified
- 5 year warranty+

DV50 ADROIT

With its powerful air volume capacity and high thermal efficiency the DV50 Adroit is suitable for smaller family homes and flats. Control your indoor air environment at home or on the go via the Adroit 'Cloud' internet control by smart phone, tablet or PC.

With the triple filter design with an F7 pollen filter, the DV50 Adroit provides additional protection against invisible, harmful particles and creates an ultra hygienic environment.

The automatic, 100% summer by-pass facility isolates the heat recovery function and helps to effectively maintain a temperate indoor air climate during the summer months.

The unit includes an easily removable, plastic heat exchanger and may be equipped with a range of optional accessories for higher performance.

PERFORMANCE

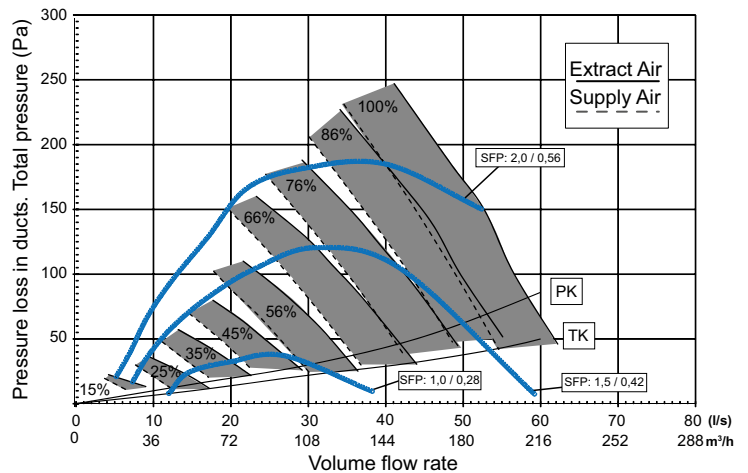

* Guidance only. Dependant upon system pressure.

DIMENSIONS

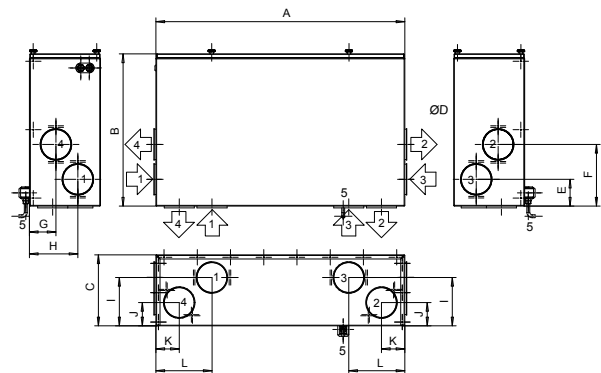

Model	A	B	C	D	E	F	G	H	I	J	K	L	M
DV50	900	547	236	100	87	197	86	161	161	86	96	206	498

Model R

Inner diameter of female outlet collar \varnothing 100mm

1. Outdoor air to the unit
2. Supply air to rooms
3. Extract air to the unit
4. Exhaust air outside
5. Condensate drain

Model L

Inner diameter of female outlet collar \varnothing 100mm

1. Extract air to the unit
2. Exhaust air outside
3. Outdoor air to the unit
4. Supply air to rooms
5. Condensate drain

+ excludes motors. Motor warranty one year from date of purchase

TECHNICAL DATA

Specification	DV50
Suitable for dwellings up to m ²	80
Max air flow (m ³ /h) / (l/s) at 100Pa.	187 / 52
Thermal efficiency (%)	Up to 90
Heat exchanger	Cross-Counter-Flow (Plastic)
Fans	EC
Summer by-pass damper	100% automatic
Integral humidity sensor (RH %)	0 - 100
Frost protection (optional)	Smart Frost
Controls (optional)	Digital - 4 Profiles, 100% adjustable Manual - 4 Speed controller, adjustable
Connection to BMS	Modbus / KNX optional
Mounting	Ceiling
Sound power level @3m (dB(A))	49
Duct diameter (mm)	100 (4 ports)
Condensate discharge (ins)	3/4 BSP
Electrical supply	230 V / 1 ph / 50 Hz
Max. power consumption (W)	97
Filter Class	2 x G4 (ISO Coarse > 75%), 1 x F7 (ISO ePM1)
Built-in electric post-heater (optional) (W)	900
Protection class	IP34
Casing insulation (mm)	20
Weight (kg)	45
Dimensions (L x D x H) (mm)	900 x 547 x 236
Duct entry	Side Entry
Versions available	
Right Hand:	90000584
With optional electric post-heater:	90000584EPH
Left Hand:	90000585
With optional electric post-heater:	90000585EPH

ACCESSORIES

Adroit Digital Controller

Wall mounted, LCD display with four 100% independently user adjustable air flow profiles (Home, Away, Boost, Fireplace). A range of indoor parameters ie: air flow rates, temperature, humidity, by-pass, time clock settings, CO₂ sensor, filter alert are adjustable to suit your indoor environment. Internet connectivity via Adroit 'Cloud' for control at home or on the go.

Adroit Speed Controller

Wall mounted, four speed (independently adjustable) rotary switch air flow controller.

Visit airflow.com for Adroit controls options data sheet.

Accessory	Product Code
Adroit Digital Controller	90000610
Adroit Relative Humidity Transmitter	90000612
Adroit CO ₂ Transmitter	90000613
Adroit Speed Controller (manual)	9041219
2 x Additional 1500W Heaters for DV245 (R + L)	90000630
Filter Set (2 x G4 ISO Coarse > 75%), 1 x F7 (ISOePM1)	90000611
Boost Switch	90000542
KNX-Converter	90000723

CERTIFICATION

The DV50 Adroit meets requirements set out by the Energy Related Products (ErP) Directive 2016, achieving an A rating. You can find out more about the ErP Directive at: www.airflow.com

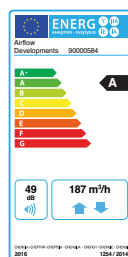

The DV50 was tested and has achieved Passive House Approval by the Passive House Institute when equipped with the optional Electric Post-heater.



DV50 Adroit

Adroit Line Top Entry -
Up to 195 m³/h air volume

The DV50 Adroit is fitted with a unique triple air filter facility. It comes with two G4 (ISO Coarse > 75%) and one F7 (ISOePM1) filters, which provides additional air filtration by prevent particles as small as pollen from entering the premises. This is of particular benefit to those that suffer from asthma or hay fever and other respiratory conditions.

You can control your Adroit unit via internet or local network using laptop, smartphone, tablet etc. As an option there is a digital controller available that enables you to adjust the ventilation levels of your Adroit unit as well as setting the user profiles. The controller provides significant information to the user regarding the performance of their Adroit system including; adjusting the ventilation levels, filter maintenance, separate fan control, faults in the system and commissioning the system. You can also use an optional manual controller which provides simple control by switching ventilation profiles.

Through combining your unit with additional humidity and CO₂ sensors, you are able to achieve on-demand ventilation for the property. This is possible, as due to changes to humidity and CO₂ levels that occur through changes in occupancy or usage, the ventilation will boost or reduce to match demand; without the need of manual intervention.

The DV50 can be integrated with a Building Management System (BMS) via a Modbus connection or KNX, which allows the user to monitor and control the unit's functions via a central control system.

NEW SMART FROST PROTECTION

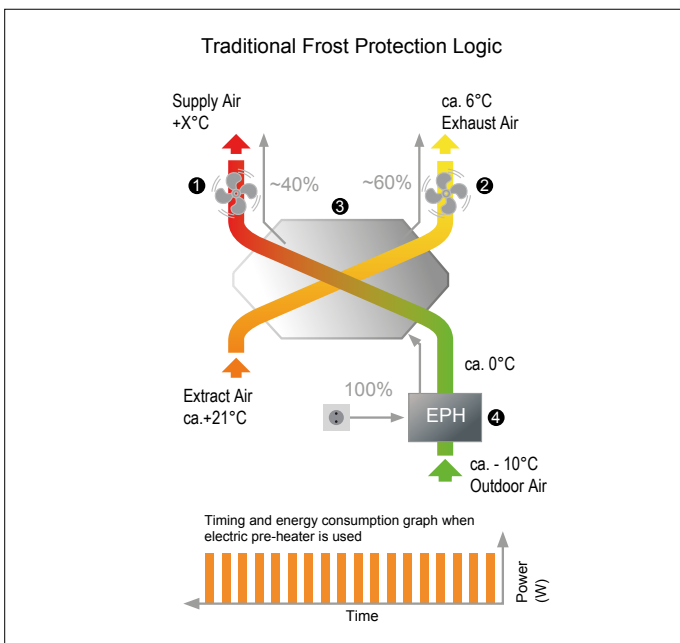

On the traditional frost protection method, the outdoor air is pre-heated before passing through the heat exchanger. This way the unit could still provide balanced ventilation even when the frost protection was on. However, the electric heater kicks in intermittently hence consumes more energy than needed.

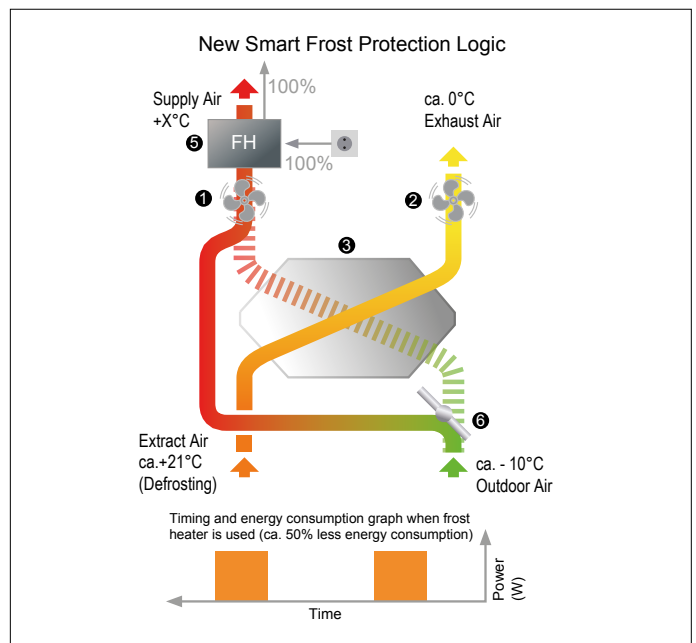

The new Smart Frost Protection method works in a more energy efficient manner which constantly monitors the heat exchanger conditions and uses the frost heater only when necessary. This significantly reduces the energy consumption and provides more heat recovery throughout the winter season.

- 1 Supply air fan
- 2 Exhaust air fan
- 3 Heat exchanger
- 4 Electric pre-heater
- 5 Frost heater
- 6 Electric bypass damper

ACCESSABILITY

Landlords can protect their investment by insuring planned maintenance from outside the dwelling to preserve building fabric, ensure occupier wellbeing and save energy **without the need to access the dwelling or disturb the tenant.**

This significantly shortens maintenance time and saves on service cost.



Easy access to replace filters

Heat Recovery

Removable, secure front cover panel for maintenance

Removable Heat Exchanger, for quick cleaning

Durable steel double skin casing with 20mm insulation



100% AUTOMATIC BYPASS

The unit is equipped with an automatic, 100% bypass which totally isolates the heat exchanger so that no air passes through it. This prevents overheating the dwelling in the summer season.

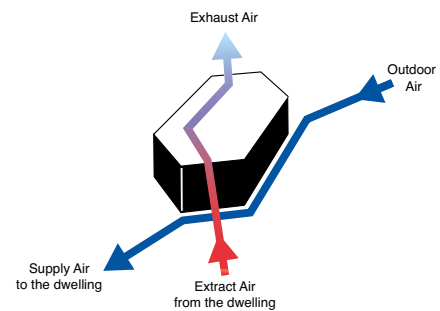

CONTROLS

Ideal indoor air quality is achieved by automatically **adjusted ventilation**

Adroit DV50 is controlled via 4 ventilation profiles controls providing the following features:

- **4 ventilation profiles**, 100% adjustable
- **Internet** connection available
- **Automatic boost function** with delay timer
- **Filter maintenance reminder** via counter clock (standard)
- **Heater control** for optional post-heater
- **Connection to BMS** via LON or KNX
- **Self diagnostic** via fault signal relay
- **On-demand control** via humidity and CO₂ sensors
- **Separate fan control** for ease of commissioning
- **Weekly ventilation programming** allows users to pre-set the ventilation levels scheduled for different days
- **Indoor temperature control** based on extract air temperature or supply air temperature

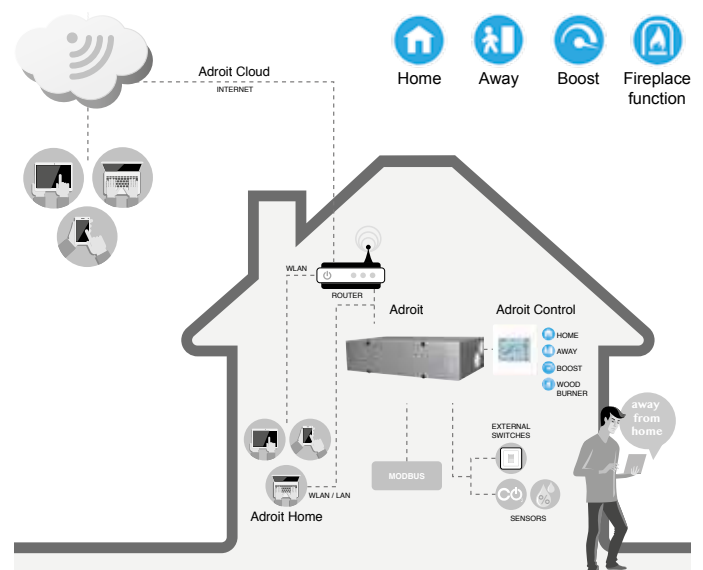

DV80 Adroit

Adroit Line Top Entry -
Up to 299 m³/h air volume



KEY FEATURES

- For use in dwellings up to 120 m²*
- Up to 90% thermal efficiency and low SFP
- 'A' energy rating
- Internet control by smart phone, tablet or PC
- Triple filter design with F7 pollen filter
- Automatic, 100% summer by-pass
- Integral Humidity Sensor
- Galvanised steel, double-skin casing
- BMS (Modbus / KNX) connection
- Optional LCD digital controller with four independent environmental profiles
- Optional manual four speed controller
- Auto cut-out switch for extra safety
- Optional built-in Electric Post-heater
- Optional smart frost protection
- Complies with Building Regulations and Passive House certified
- 5 year warranty+

DV80 ADROIT

With its powerful air volume capacity and high thermal efficiency the DV80 Adroit is suitable for smaller family homes and flats. Control your indoor air environment at home or on the go via the Adroit 'Cloud' internet control by smart phone, tablet or PC.

With the triple filter design with an F7 pollen filter, the DV80 Adroit provides additional protection against invisible, harmful particles and creates an ultra hygienic environment.

The automatic, 100% summer by-pass facility isolates the heat recovery function and helps to effectively maintain a temperate indoor air climate during the summer months.

The unit includes an easily removable, plastic heat exchanger and may be equipped with a range of optional accessories for higher performance.

PERFORMANCE

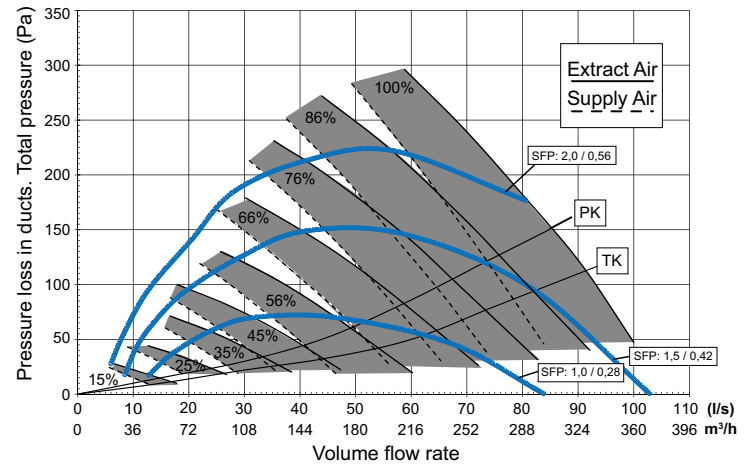

* Guidance only. Dependant upon system pressure.

DIMENSIONS

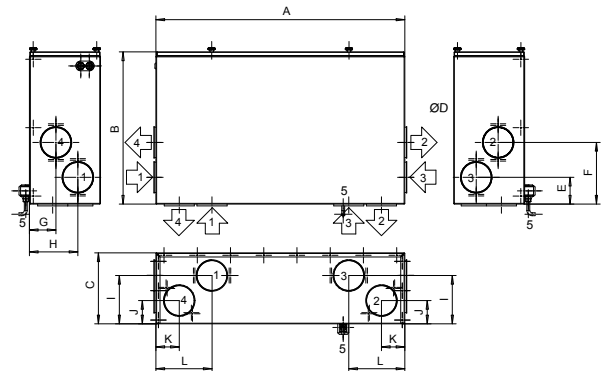

Model	A	B	C	D	E	F	G	H	I	J	K	L	M
DV80	1026	626	293	125	110	254	110	200	200	96	96	231	624

Model R

Inner diameter of female outlet collar \varnothing 125mm

1. Outdoor air to the unit
2. Supply air to rooms
3. Extract air to the unit
4. Exhaust air outside
5. Condensate drain

Model L

Inner diameter of female outlet collar \varnothing 125mm

1. Extract air to the unit
2. Exhaust air outside
3. Outdoor air to the unit
4. Supply air to rooms
5. Condensate drain

+ excludes motors. Motor warranty one year from date of purchase

TECHNICAL DATA

Specification	DV80
Suitable for dwellings up to m ²	120
Max air flow (m ³ /h) / (l/s) at 100Pa.	285 / 79
Thermal efficiency (%)	Up to 90
Heat exchanger	Cross-Counter-Flow (Plastic)
Fans	EC
Summer by-pass damper	100% automatic
Integral humidity sensor (RH %)	0 - 100
Frost protection (optional)	Smart Frost
Controls (optional)	Digital - 4 Profiles, 100% adjustable Manual - 4 Speed controller, adjustable
Connection to BMS	Modbus / KNX optional
Mounting	Ceiling
Sound power level @3m (dB(A))	52
Duct diameter (mm)	125 (4 ports)
Condensate discharge (ins)	3/4 BSP
Electrical supply	230 V / 1 ph / 50 Hz
Max. power consumption (W)	158
Filter Class	2 x G4 (ISO Coarse > 75%), 1 x F7 (ISO ePM1)
Built-in electric post-heater (optional) (W)	900
Protection class	IP34
Casing insulation (mm)	20
Weight (kg)	59
Dimensions (L x D x H) (mm)	1026 x 626 x 293
Duct entry	Side Entry
Versions available	
Right Hand:	90000586
With optional electric post-heater:	90000586EPH
Left Hand:	90000587
With optional electric post-heater:	90000587EPH

ACCESSORIES

Adroit Digital Controller

Wall mounted, LCD display with four 100% independently user adjustable air flow profiles (Home, Away, Boost, Fireplace). A range of indoor parameters ie: air flow rates, temperature, humidity, by-pass, time clock settings, CO₂ sensor, filter alert are adjustable to suit your indoor environment. Internet connectivity via Adroit 'Cloud' for control at home or on the go.

Adroit Speed Controller

Wall mounted, four speed (independently adjustable) rotary switch air flow controller.

Visit airflow.com for Adroit controls options data sheet.

Accessory	Product Code
Adroit Digital Controller	90000610
Adroit Relative Humidity Transmitter	90000612
Adroit CO ₂ Transmitter	90000613
Adroit Speed Controller (manual)	9041219
2 x Additional 1500W Heaters for DV245 (R + L)	90000630
Filter Set (2 x G4 ISO Coarse > 75%), 1 x F7 (ISOePM1)	90000611
Boost Switch	90000542
KNX-Converter	90000723

CERTIFICATION

The DV80 Adroit meets requirements set out by the Energy Related Products (ErP) Directive 2016, achieving an A rating. You can find out more about the ErP Directive at: www.airflow.com

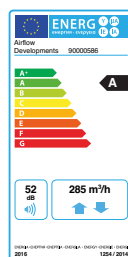

The DV80 was tested and has achieved Passive House Approval by the Passive House Institute when equipped with the optional Electric Post-heater.



DV80 Adroit

Adroit Line Top Entry -
Up to 299 m³/h air volume

The DV80 Adroit is fitted with a unique triple air filter facility. It comes with two G4 (ISO Coarse > 75%) and one F7 (ISOePM1) filters, which provides additional air filtration by prevent particles as small as pollen from entering the premises. This is of particular benefit to those that suffer from asthma or hay fever and other respiratory conditions.

You can control your Adroit unit via internet or local network using laptop, smartphone, tablet etc. As an option there is a digital controller available that enables you to adjust the ventilation levels of your Adroit unit as well as setting the user profiles. The controller provides significant information to the user regarding the performance of their Adroit system including; adjusting the ventilation levels, filter maintenance, separate fan control, faults in the system and commissioning the system. You can also use an optional manual controller which provides simple control by switching ventilation profiles.

Through combining your unit with additional humidity and CO₂ sensors, you are able to achieve on-demand ventilation for the property. This is possible, as due to changes to humidity and CO₂ levels that occur through changes in occupancy or usage, the ventilation will boost or reduce to match demand; without the need of manual intervention.

The DV80 can be integrated with a Building Management System (BMS) via a Modbus connection or KNX, which allows the user to monitor and control the unit's functions via a central control system.

NEW SMART FROST PROTECTION

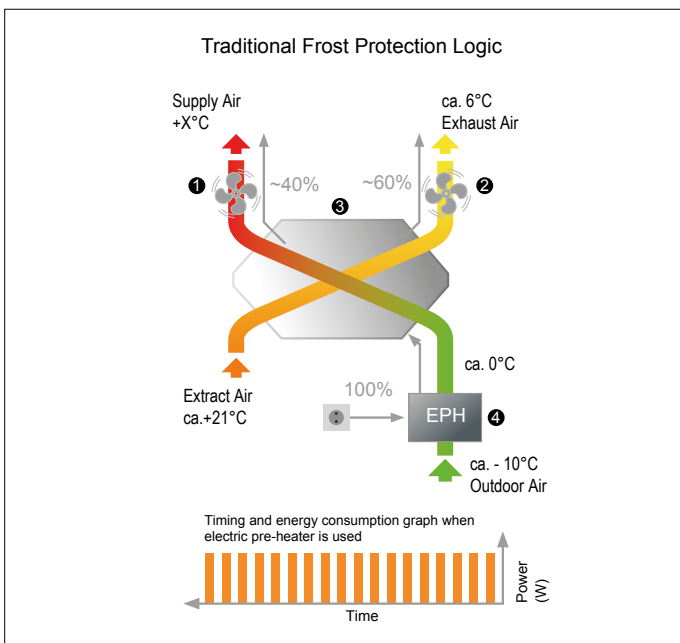

On the traditional frost protection method, the outdoor air is pre-heated before passing through the heat exchanger. This way the unit could still provide balanced ventilation even when the frost protection was on. However, the electric heater kicks in intermittently hence consumes more energy than needed.

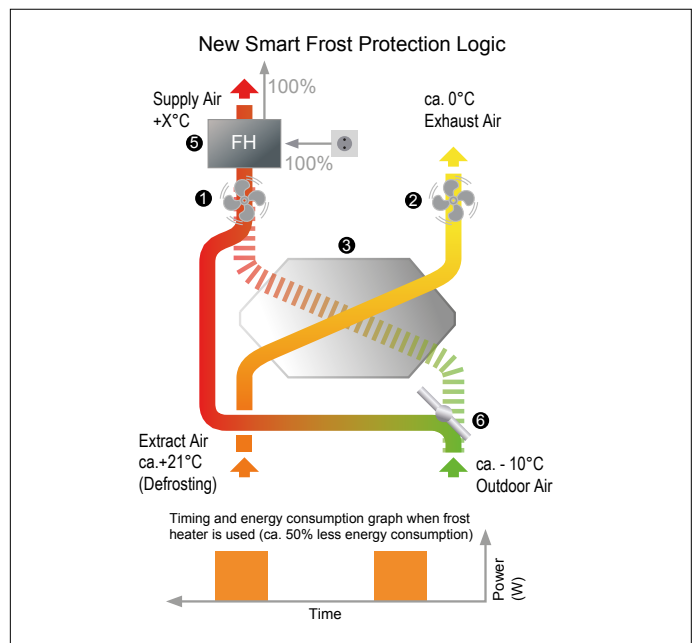

The new Smart Frost Protection method works in a more energy efficient manner which constantly monitors the heat exchanger conditions and uses the frost heater only when necessary. This significantly reduces the energy consumption and provides more heat recovery throughout the winter season.

- 1 Supply air fan
- 2 Exhaust air fan
- 3 Heat exchanger
- 4 Electric pre-heater
- 5 Frost heater
- 6 Electric bypass damper

ACCESSABILITY

Landlords can protect their investment by insuring planned maintenance from outside the dwelling to preserve building fabric, ensure occupier wellbeing and save energy **without the need to access the dwelling or disturb the tenant.**

This significantly shortens maintenance time and saves on service cost.



Easy access to replace filters

Heat Recovery

Removable, secure front cover panel for maintenance

Removable Heat Exchanger, for quick cleaning

Durable steel double skin casing with 20mm insulation



100% AUTOMATIC BYPASS

The unit is equipped with an automatic, 100% bypass which totally isolates the heat exchanger so that no air passes through it. This prevents overheating the dwelling in the summer season.

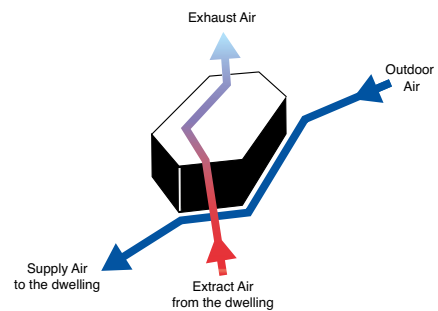

CONTROLS

Ideal indoor air quality is achieved by automatically **adjusted ventilation**

Adroit DV80 is controlled via 4 ventilation profiles controls providing the following features:

- **4 ventilation profiles**, 100% adjustable
- **Internet** connection available
- **Automatic boost function** with delay timer
- **Filter maintenance reminder** via counter clock (standard)
- **Heater control** for optional post-heater
- **Connection to BMS** via LON or KNX
- **Self diagnostic** via fault signal relay
- **On-demand control** via humidity and CO₂ sensors
- **Separate fan control** for ease of commissioning
- **Weekly ventilation programming** allows users to pre-set the ventilation levels scheduled for different days
- **Indoor temperature control** based on extract air temperature or supply air temperature

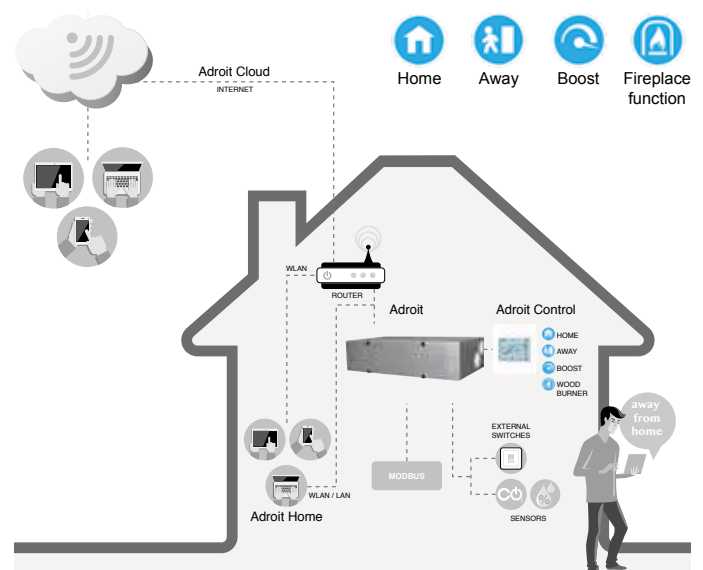

MultiPlexBox

COMBINE A CENTRAL DUPLEXVENT UNIT WITH MULTIPLEX

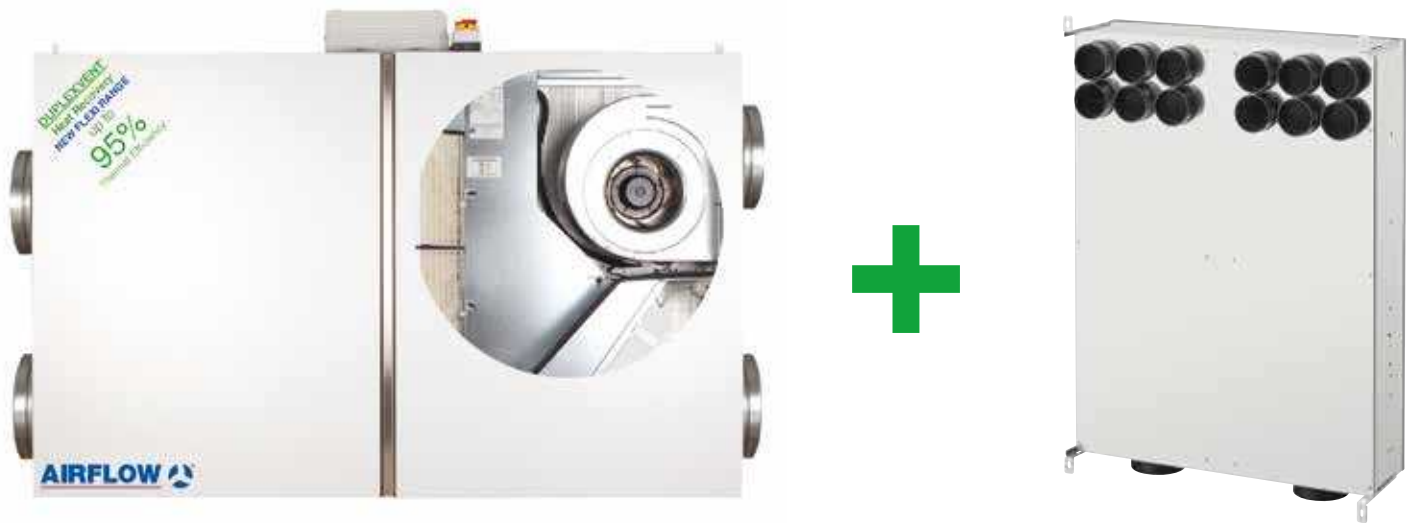

Local demand supply and extraction, central large Mechanical unit with Heat Recovery

A Multiplex distribution box gives you volume flow control, sound attenuation, system control and control of the fresh air around the apartment.

It is used in conjunction with our **AIRFLEX PRO** ducting and components to provide a low energy leak free system.



Always fits
The right box for every requirement. Whether for ceiling or wall installation. Airflex Pro is compatible with MultiPlexBox.

Quick installation
One single compact box is installed rather than numerous individual components. With its integrated mounting bracket, it is also fixed into place in no time.

Brilliantly quiet
The large-scale sound attenuation elements ensure silent operation. Thus, the MultiPlexBox is especially suited for noise sensitive environments.

Maintenance free
Expendable and wear parts have been completely avoided in the design of the MultiPlexBox. However, the integrated inspection opening makes it easy to make sure that "all is well" if desired.

All automatic
The optional room air sensor turns the MultiPlexBox into a complete demand driven ventilation unit. Manual user intervention is not required.

Unique
The revolutionary technology safely ensures the predefined volume flow – independently, continuously and with the highest precision.

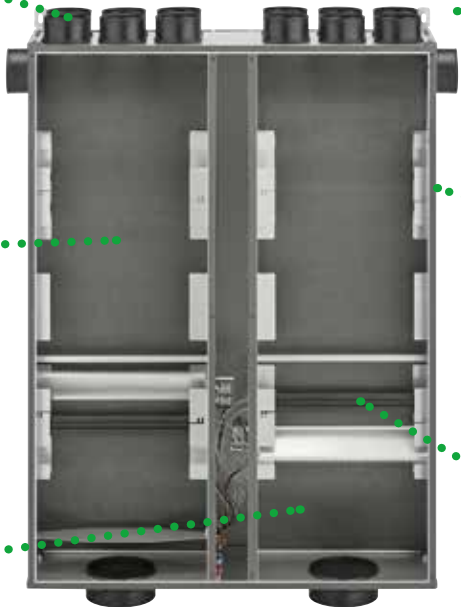

DIMENSIONS

MutiPlexBox Right 90° 125 mm x 75 mm

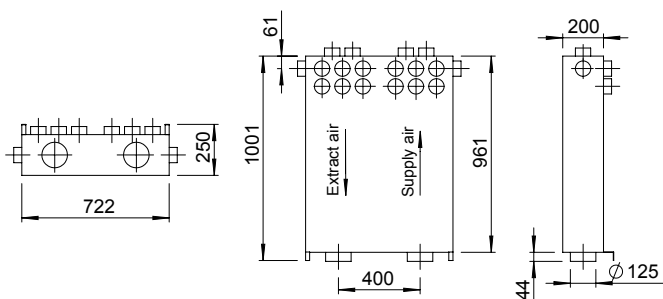

Compact unit for the connection of supply and extract air dia. 125 mm and 2 sets of 7 single nozzles dia. 75 mm with the supply air on the right side.

MutiPlexBox Left 90° 125 mm x 75 mm

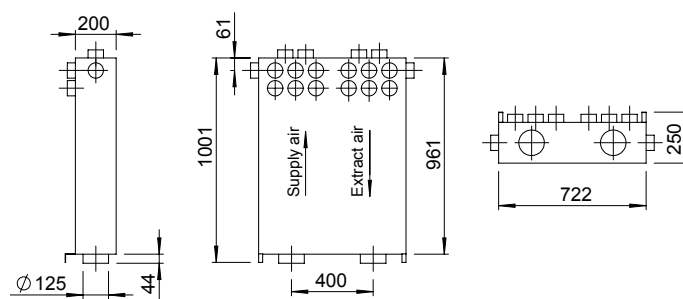

Compact unit for the connection of supply and extract air dia. 125 mm and 2 sets of 7 single nozzles dia. 75 mm with the supply air on the left side.

MutiPlexBox Straight-through 125 mm x 75 mm

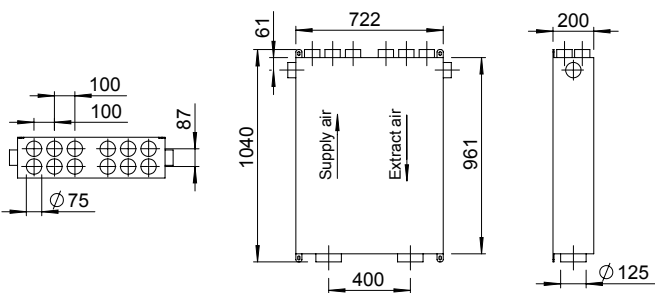

Compact unit for the connection of supply and extract air dia. 125 mm and 2 sets of 7 single nozzles dia. 75 mm.

MutiPlexBox Straight-through 125 mm x 125mm

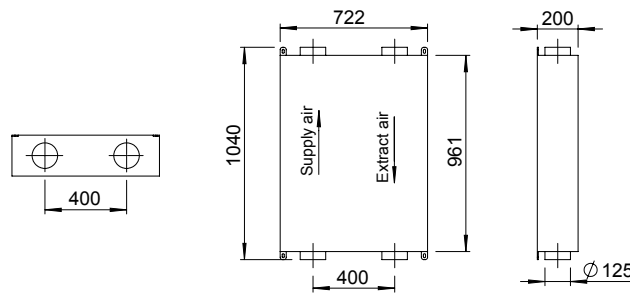

Compact unit of supply and extract. Both supply and extract from outside and supply and extract from the apartment are dia. 125 mm.

YOUR BENEFITS:

- Compact dimensions for external wall installation with minimum space requirements.
- Economical EC fans for maximum energy efficiency.
- Heat recovery efficiency of up to 88 %.
- Convenient control, can be connected to extractor fans for combined ventilation.
- Simple commissioning by connecting the controller to the PC or laptop.
- Multiple award-winning design, perfectly suitable for the Airflow extract fans from the QuietAir range.



AN EFFICIENT VENTILATION SYSTEM IN A FLASH

The Unohab opens up completely new possibilities for the economical ventilation of single rooms. The Unohab is particularly useful if there is limited space available due to its compact dimensions, whether it is used in new construction or a renovation, for single-family houses or apartment buildings.

The heat recovery is regenerative with the help of a ceramic heat accumulator. During extract air operation, this absorbs and stores the heat from the indoor air in a ceramic accumulator, so that the recovered heat can be transferred to the incoming fresh air during the subsequent supply air phase.

The ceramic accumulator is dirt-repellent due to the smooth surface that ensures constant hygienic operation in connection with the protection grille and the integrated filter. For the sake of balanced ventilation, one functional system consists of a minimum of two units, which operate in their operating modes (supply air/extract air) in alternating phases. Furthermore, the total number of ventilation units depends on the air requirement of the dwelling. In this respect, the volume flows of the individual units are perfectly coordinated with each other by means of the central control unit.

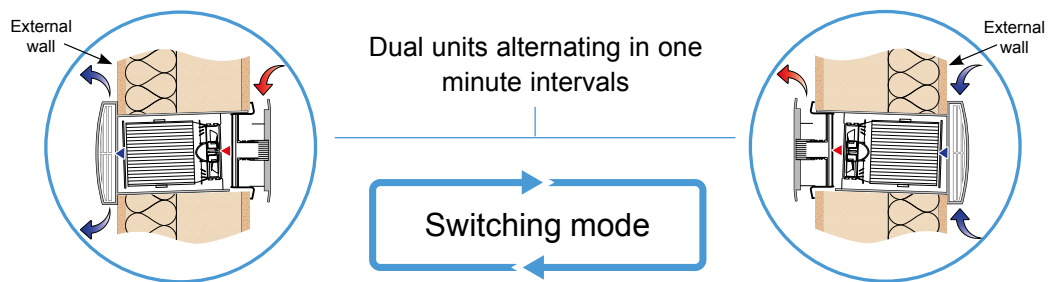

Extract air
During the extract air phase, the ceramic exchanger absorbs and stores the heat from the room air (storage charging).

Supply air
During the supply air phase, the fresh outside air absorbs the heat from the ceramic accumulator and this pre-heated air flows into the room.

With a balanced system one unit brings in air from the outside, whilst the other extracts

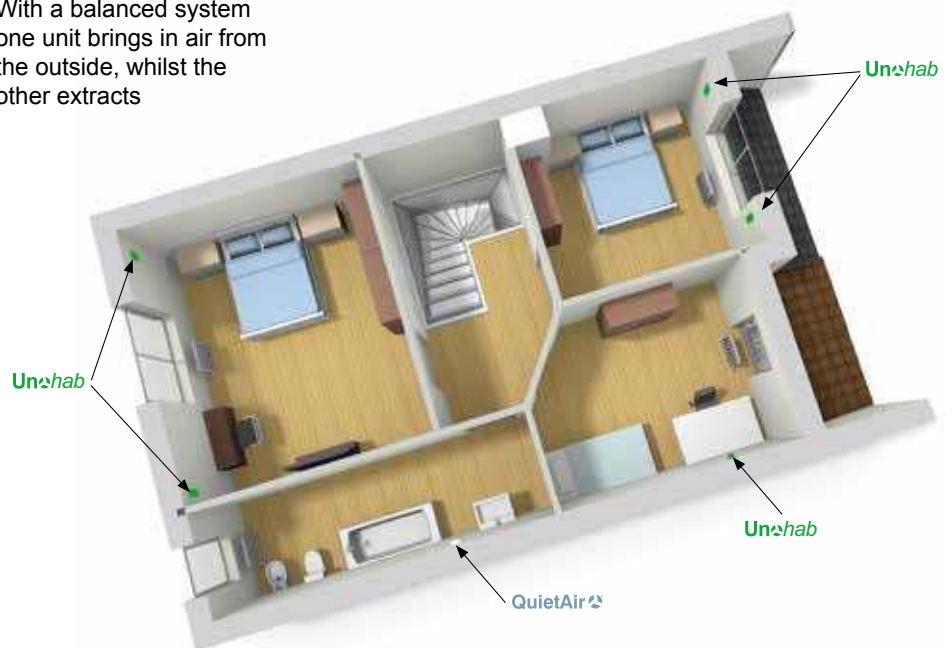

UnoHab: AWARD-WINNING DESIGN

FEATURES AND BENEFITS:

- Economical to operate with silent EC axial fan technology
- Elegant and unobtrusive design to blend with interior décor
- Flow rate up to 45 m³/h
- Up to 88% heat recovery efficiency
- Internal vent with efficient German design
- Easily installed with basic tools
- Very efficient core with flow straightening characteristics, culminating in high heat recovery and quiet operation
- Optional sound insulation elements to reduce the sound operation by maximum of 8 dB from the total sound pressure level
- ISO Coarse 50% (G4) air filter as standard, easily accessible which can be exchanged without tools
- Simple to adjust settings through its intuitive software
- LED display of current operating mode and fan speed
- Up to eight units may be controlled simultaneously
- Three operating modes (heat recovery, cross ventilation and supply air only)

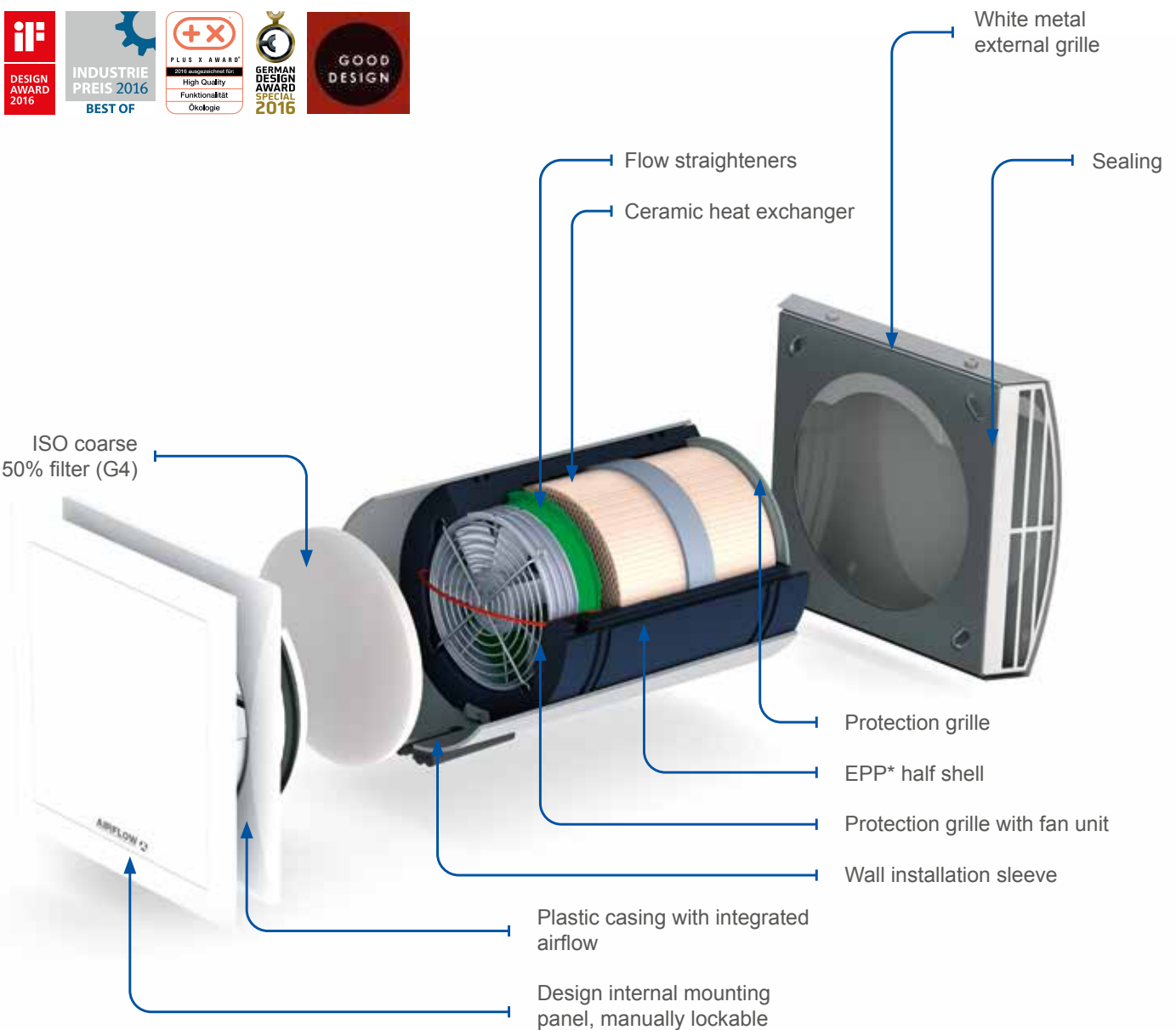

* expanded polypropylene

Technical data	Unohab unit		
Fan speed	1*	2*	3*
Air flow supply/extract rate in Cross ventilation and Supply only mode [m³/h]	14	32	45
Sound pressure level LPA dB(A)	14	27	34
Sound insulation Dn,e,w	44 dB		
Power consumption [W]	1.6	2.8	4.5
Heat recovery efficiency	up to 88%		
Power supply	Input 230V~ 50/60Hz / Output 12VDC		
Rated current [mA]	17	27	42
Protection class	IP20		
El. supply line power supply unit	NYM-O 2 x 1.5mm²		
El. supply line power supply control	NYM-O 2 x 1.5mm²		
El. supply line to the fan	J-Y (ST) Y 3x0.8mm²		
Connection according to wiring diagram no.	SD-3 / SD-4		
Weight approx.	4.3 kg		
Working range temperature	-12°C up to +40°C		

PERFORMANCE

Unohab heat recovery system is specially designed to improve indoor air quality and reduce the risk of condensation and mould.

When running at the average speed, single room heat recovery units are more efficient than standard extract ventilation units. In addition, they can be much easier to install as the customer will have two options to choose from: through the wall installation or by using the external insulation vent kit through the window wall. By having a choice, the customer can customise the entire heat recovery system according to their requirements.

Recovering up to 88% of heat, the Unohab unit is an innovative way of saving energy. Not only Unohab has a high efficiency grade but can also reduce the carbon emissions and other pollutants coming from the outdoor air.

The Unohab unit functions in three fan speed: low, average and boost. The fan performance can vary depending upon the running speed.

The performance graph shows maximum air flow against pressure at a dry air density of 1.2041 kg/m³. The maximum pressure induced by an Unohab unit is 40 Pa when running at the highest speed (boost). As the lowest pressure is 5 Pa when running at the lowest speed. Depending upon the controller setting, commissioning and customers' requirements, the fan can run at an average level in between the highest and lowest speed giving the best performance.

The Unohab unit performance is directly associated with its axial EC motor. Thanks to the EC fans, the demand of energy is lowered, and the motor has got a longer lifetime. The EC fans are economically used for maximum energy efficiency.

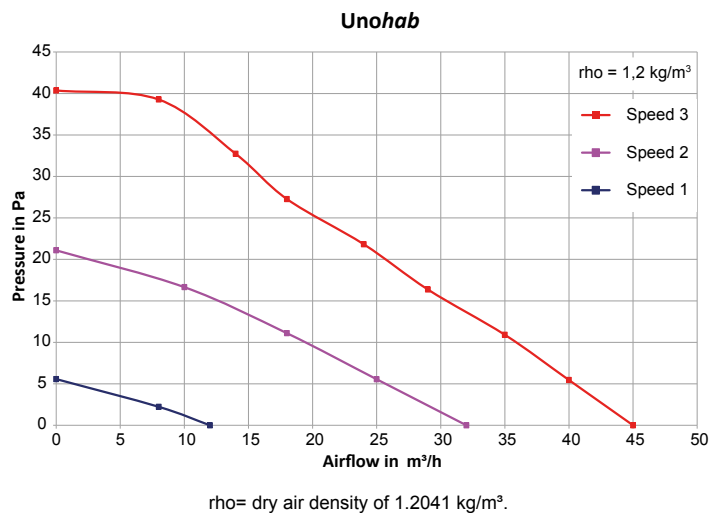

The ceramic heat recovery core has a high efficiency recovering up to 88% heat from the extracted air and transferring it to the supply air. The German design heat exchanger allows a large quantity of heat to be transferred due to its conductive and accumulative properties. Also, the ceramic heat exchanger is insulated with a heat insulating material (EPP=Expanded Polypropylene) layer so the heat recovered and stored into the core will not outflow.

The Unohab system can form a whole-house system within each individual Unohab unit will be perfectly coordinated and synchronized with each other.

Unohab COMPLETE KITS

Unohab CAVITY WALL INSTALLATION KIT



Part Number: 90001177

Kit for installation through the wall for one unit.
Consists of one Unohab unit and one cavity wall
installation kit.

Unohab INSULATION VENT KIT



Part Number: 90001178

Kit for installation on the window wall through the
external wall insulation insulation vent kit.
Consists of one Unohab unit and one external
wall insulation vent kit.

CONTROLLER FLUSH MOUNTED KIT



Part Number: 90001179

Controller kit consists of one controller, one
back box, one switching power supply for flush
mounting and one extractor fan module to
connect to the bathroom fan.

CONTROLLER DIN RAIL MOUNTED KIT



Part Number: 90001180

Controller kit consists of one controller, one
back box, one switching power supply for DIN
rail mounting and one extractor fan module to
connect to the bathroom fan.



UNITED KINGDOM (head office)
Airflow Developments Limited
Aidelle House, Lancaster Road
Cressex Business Park
High Wycombe, Bucks. HP12 3QP.

Tel: +44 (0) 1494 525252
Email: info@airflow.com
Web: airflow.com

GERMANY
Airflow Lufttechnik GmbH
Wolbersacker 16
53359
Rheinbach, Germany

Tel: +49 (0) 2226 92050
Email: info@airflow.de
Web: airflow.de

CZECH REPUBLIC
Airflow Lufttechnik - Praha
Hostynska 520
10800 Praha 10
Prague, Czech Republic

Tel: +42 (0) 2747 72230
Email: info@airflow.cz
Web: airflow.cz