



**LOOVENT eco** dMEV SELV Fan Range  
Installation and Operating Guide



LVECODST - 72684312  
LVECODSHT - 72684313



**Fan dimensions**

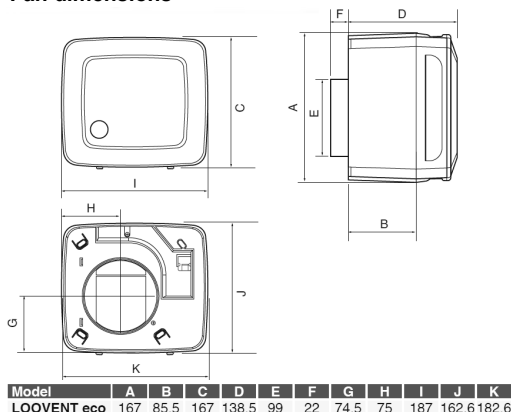

**Fan overview**

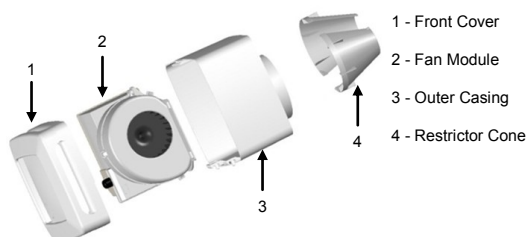

**Range overview**

LOOVENT eco dMEV SELV fans are designed for ventilation of domestic premises. They can be recessed or surface mounted in walls or ceilings, in a portrait or landscape orientation.

**Continuous Operation**

Continuous Operation has three trickle speeds, 7,9 and 16 l/sec as well as two boost speeds 15, and 31 l/sec. These speeds are selectable on install by using the restrictor cone and dip switch settings found on P14. More information on dip switches and the 2 minute delay boost feature found on P11.

**LVECODST** - Continuous operation on selected Trickle flow rate. Boost flow rate activated via switch live or pull cord with an adjustable timer overrun from 2 to 45 minutes.

**LVECODSHT** - Continuous operation on selected trickle flow rate. Boost flow rate activated via switch live, pull cord, or 40-90% adjustable humidity sensor, with an adjustable timer overrun from 2 to 45 minutes.

**Intermittent Operation**

Intermittent operation mode has two speeds, 17 & 31 l/sec as well as a 2 minute delay start function selectable on install using by dip switches (more information on P11). All models also include a momentary pull cord which does not click when used.

**LVECODST** - Activation of selected speed via switched live with an adjustable timer overrun from 2 to 45 minutes. Pull cord activation will always run at 31 l/sec speed.

**Intermittent Operation Cont'd**

**LVECODSHT** - Activation of selected speed via switched live with an adjustable timer overrun from 2 to 45 minutes. Humidity sensor can be adjusted between 40 to 90%. Activation of fan via humidity will always run at 31 l/sec speed. Pull cord activation will always run at 31 l/sec speed.

**Electrical installation**

The LOOVENT eco dMEV SELV fan range is IPX5 rated and is suitable for mounting in Zone 1 when installed with a 30mA RCD.

The fan requires a 220 - 240V 50/60Hz single phase supply. Class II equipment. BS EN 60417. An external 3A fuse is required for each fan unit. Cable sizes (max): Fixed flat wiring 2 core 1mm<sup>2</sup>, 3 core 1/1.5mm<sup>2</sup>

All electrical installation work to be carried out by a competent person in compliance with the relevant Building Regulations/Standards as well as the current edition of BS7671 (IET Wiring Regulations).

**Important notes**

The LOOVENT eco dMEV SELV range also complies with the requirements of the EU norms and directives. Do not place the ventilator near direct heat sources, e.g. radiant heaters, or where temperatures can exceed 40°C (104°F). Precautions must be taken to avoid back flow of gases in rooms with open flue fuel burning appliances. The power supply unit (12V DC transformer) supplied with the fan, should be fitted outside of Zones 0,1 & 2 usually outside the room. The maximum length of wire between the power supply and the fan should not exceed 5m using 1.5mm<sup>2</sup> wire. Never cover the power supply unit with thermal insulation materials.

**Electrical installation**

**SELV Power Supply**

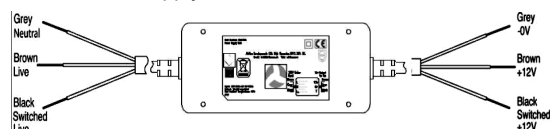

**Wiring for fans with no external switching**

(Pull cord and feature activation only i.e. Humidity)

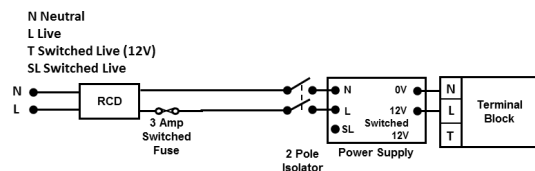

**Wiring for fans with external switching**

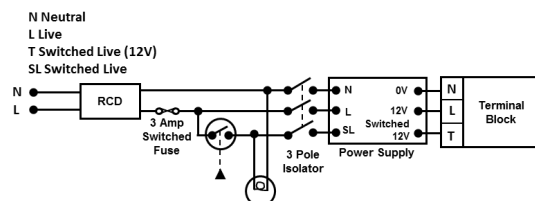

**Front cover removal**

To remove front cover, apply finger pressure to the two semi-circular buttons at the edge of the cover (see below). To remove the cover completely, pivot it to 90° and lift away (see below). To refit, reverse the above procedure.

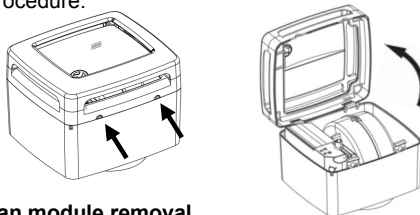

**Fan module removal**

Remove the accessories from the body of the fan. The fan module is released by undoing the two retaining screws alongside the fan housing (see below). Lift the left side of the module as viewed slightly and slide to the right to release from the two lugs in the base (see below). When the module is removed the terminal block will be attached to the back of the module. This should be removed to enable wiring.

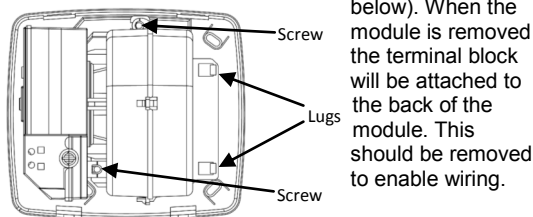

Power connections are made through the terminal block as shown below. Prepare the cable by leaving a length of 60mm protruding from inside the base of the fan. Strip the conductor insulation back by 5mm and connect to the terminal block (see page 5). Once connections have been made, clip the terminal block back into location as shown below.

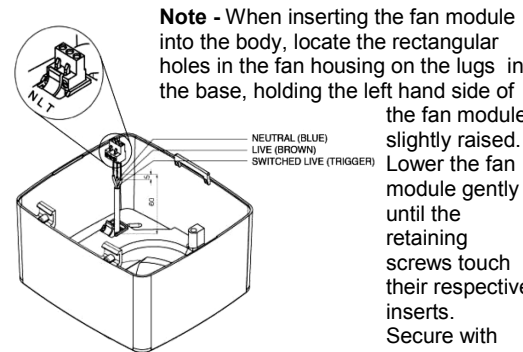

**Note:** All LOOVENT eco dMEV SELV fans are fitted with a safety feature which means the fan will not run without the front cover secured. Secure the front cover before attempting to start the fan.

**Mechanical Installation - Wall**

The fan can be mounted "landscape", with the release buttons facing downwards or "portrait" with the buttons on the right hand edge. The fan requires a 110mm diameter hole through the external wall lined with a 100mm internal diameter duct kit. To recess the fan a hole of 195 x 175 x 80mm deep is required.

**Important:** refer to the enclosed mounting template in the box for location of recess and fixing screws relative to the exhaust ducting.

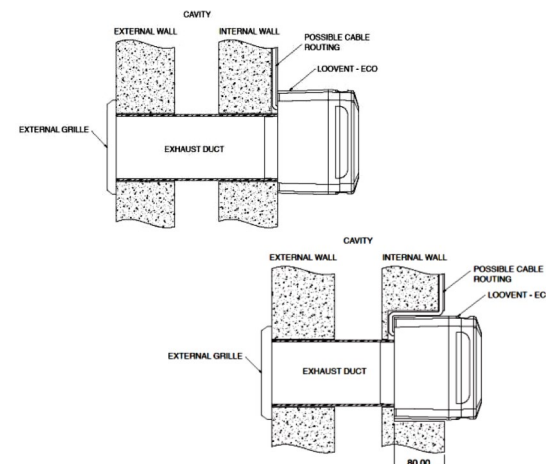

## Mechanical Installation - Ceiling

When recessing fans in the ceiling, a plywood support panel (min 18mm thick) should be fixed between the ceiling joists to support the fan (see below) 80 to 85mm from the ceiling. The LOOVENT eco dMEV SELV requires a 110mm diameter hole through the support panel and a rectangular cut-out in the ceiling board. (Refer to the enclosed mounting template for shape, size & location of the recess relative to the 110mm diameter hole). With the screws provided, fix the fan to the support panel.

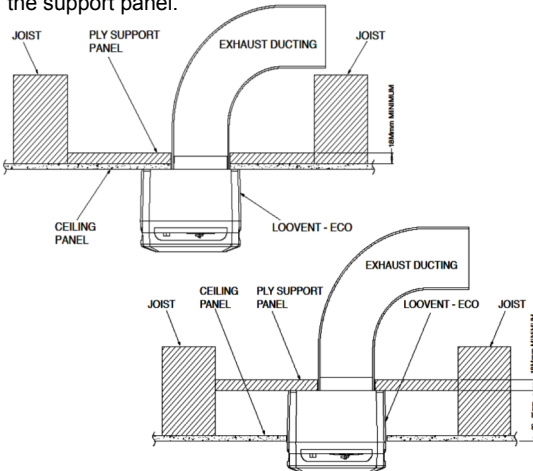

Page 9 of 16

## Installation with flexible ducting

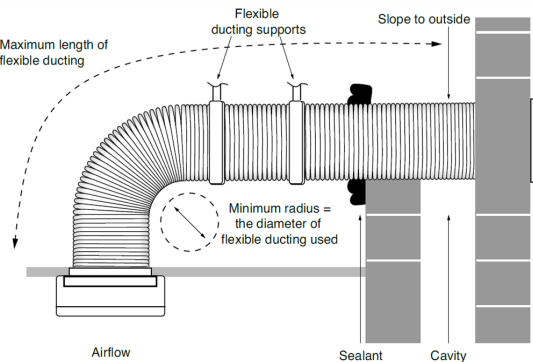

Where flexible ducting is used the diameter must be maintained and it is good ventilation practice that the ducting is extended to 90% of its possible length in order to maintain the best possible airflow. Ensure that flexible duct connections are not over tightened to the fan outlet spigot. To maximise airflow rigid ducting should be used. The fan and ducting should be installed in accordance with the requirements of the Domestic Ventilation Compliance Guide, part of the Building Regulations.

Page 13 of 16

## Restrictor Cone

All LOOVENT eco dMEV SELV fans are supplied with a restrictor cone to increase the air velocity. This is supplied as a two part assembly and should be clipped together and secured with adhesive tape (not included) to the spigot of the fan. The cone is only required for continuous trickle ventilation as per the table on P14. Normal 100mm ducting should still be connected to the spigot of the fan and not to the cone outlet.

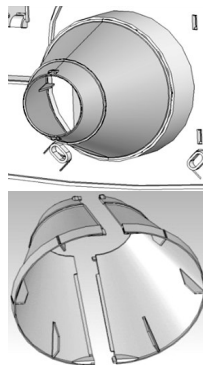

## Good practice guide

To avoid the backflow of condensation into the fan in the ceiling installations it is good practice to fit a condensation trap (optional—See [www.airflow.com](http://www.airflow.com)) to the vertical outlet duct of the fan.

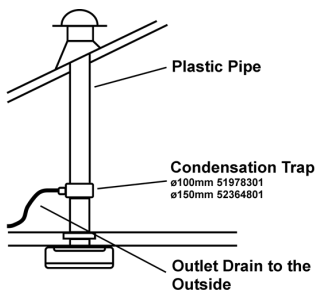

Page 10 of 16

## Continuous Flow Rate Settings

Trickle Flow Rate	Boost Flow Rate	Flow Rate Setting	Cone Fitted
7 l/sec	15 l/sec	H	Yes
9 l/sec	15 l/sec	L	Yes
16 l/sec	31 l/sec	H	No

## Recommended Best Practice

The Building Regulations 2010, Statutory Instrument Part 9, paragraph 42, imposes a requirement that testing and reporting of mechanical ventilation performance is conducted in accordance with an approved procedure.

Compliance with this requirement by an assessed and registered 'Competent Person' should follow a 'Best Practice' process and adopt air flow measurement, Method A – The Unconditional Method – using a suitable UKAS certified measuring instrument. Generically referred to as a 'Zero Pressure Air Flow Meter' or 'Powered Flow Meter'.

Further information on this method is detailed in NHBC Building Regulations Guidance Note G272a 10/13 and BSRIA 'A Guide to Measuring air flow rates' document BG46/2015

Page 14 of 16

## Fan Adjustment

When viewed in the landscape orientation, all adjustment of the fans features is done through a combination of dip switches and rotating potentiometers found on the bottom left hand corner of the fan module. This control panel will be similar to the picture (see right). Specific adjustments such as humidity will only be available on certain models.

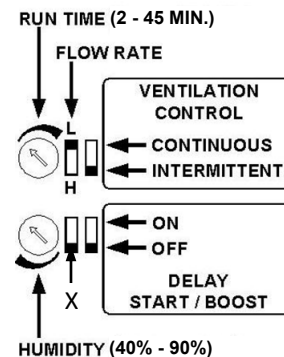

**Run Timer** - This adjusts the activation/boost timer overrun of the fan from 2 to 45 minutes. Factory set to approx. 20 mins. Rotating this clockwise will increase the timer overrun towards 45 minutes, rotating anti-clockwise will decrease the timer overrun towards 2 minutes. Adjustment of this setting should be done using the included adjustment tool.

**Humidity** - This adjusts the relative humidity that the fan will activate/boost at. Factory set to approx. 70%. Rotating this clockwise will increase the RH% activation towards 90%, this means the fan will activate at high humidity levels. Setting this too high can result in the fan never activating/boosting on humidity.

Page 11 of 16

## Maintenance

**SAFETY FIRST: ALWAYS ISOLATE THE FAN UNIT FROM THE POWER SUPPLY BEFORE REMOVING THE COVER.** When installed according to these instructions the LOOVENT eco range is completely safe. The materials used do not constitute a hazard.

## Cleaning

The external housing of the fan can be wiped with a damp cloth. Do not use household cleaners containing abrasives. **Note:** Always isolate the fan when cleaning. Never clean any parts of the fan assembly by immersing in water or using a dishwasher.

## Warning

This appliance can be used by children aged from 8 years and above and persons with reduced physical, sensory or mental capabilities or lack of experience and knowledge if they have been given supervision or instruction concerning use of the appliance in a safe way and understand the hazards involved. Children shall not play with the appliance. Cleaning and user maintenance shall not be made by children without supervision.

## Warranty

Applicable to units installed and used in the United Kingdom. Airflow Developments Ltd guarantees the LOOVENT eco SELV for 5 YEARS from date of purchase against faulty material or workmanship. Warranty only covers the fan, not the reinstallation of this if required. In the event of any defective parts being found, Airflow Developments Ltd reserve the right to repair or at our discretion replace without charge provided that the unit:

1. Has been installed and used in accordance with the fitting and wiring instructions supplied with each unit.

Rotating this anti-clockwise will decrease the RH% activation towards 40%, this means the fan will activate at low relative humidity levels. Setting this too low can result in the fan continuously running/boosting.

**Flow Rate** - Has two settings and becomes factory set to "L". For intermediate mode this means the switch live or motion sensor activation (if available) will run the fan at 17 L/sec. When switched to "H" the switch live or motion sensor activations will run the fan at 31 L/sec. Continuous mode effects can be found on P14

**Ventilation Control** - Switches the device between intermittent operation and continuous (dMEV) operation.

**X** - is spare and has no function, this should be left on the factory setting.

**Delay Start/Boost** - When switched "on" this will enable the 2 minute delay start/boost which delays the activation/boosting of the fan from the switched live input. When switched "off" all activation/boost methods will happen instantly when triggered i.e. switch live input activated fan will instantly activate/boost.

Page 12 of 16



## Warranty cont'd

2. Has not been connected to an unsuitable electrical supply.
3. Has not been subjected to misuse, neglect or damage.
4. Has not been modified or repaired by any person not authorised by Airflow Developments Ltd
5. Has been installed in accordance with latest Building Regulations and IEEE wiring regulations by a recognised competent installer.

Airflow Developments Ltd shall not be liable for any loss, injury or other consequential damage, in the event of a failure of the equipment or arising from, or in connection with, the equipment excepting only that nothing in this condition shall be construed as to exclude or restrict liability for negligence.

**This warranty does not in any way affect any statutory or other consumer rights.**



## Disposal

Do not dispose of with household waste. Please recycle where facilities exist. Check with your local authority for recycling advice.

**UK Head-Office**  
AIRFLOW DEVELOPMENTS Limited  
Aidelle House, Lancaster Road  
Cressax Business Park  
High Wycombe  
Buckinghamshire  
HP12 3QP  
United Kingdom

Tel: +44 (0) 1494 525252  
Fax: +44 (0) 1494 461073  
Email: [info@airflow.com](mailto:info@airflow.com)  
Web: [airflow.com](http://airflow.com)

**Czech Republic**  
AIRFLOW LUFTTECHNIK GmbH  
organizace slozka Praha  
Hostynská 520  
208 00 Praha 10  
Czech Republic

Tel: +42 (0) 2 7477 2330  
Fax: +42 (0) 2 7477 2370  
Email: [info@airflow.cz](mailto:info@airflow.cz)  
Web: [airflow.cz](http://airflow.cz)

**Germany**  
AIRFLOW LUFTTECHNIK GmbH  
Postfach 1208  
D-53349 Rheinbach  
Germany

Tel: +49 (0) 222 69205 0  
Fax: +49 (0) 222 69205 11  
Email: [info@airflow.de](mailto:info@airflow.de)  
Web: [airflow.de](http://airflow.de)

Page 15 of 16

Page 16 of 16